

Sharp - 22W 17° 3000K Trimless

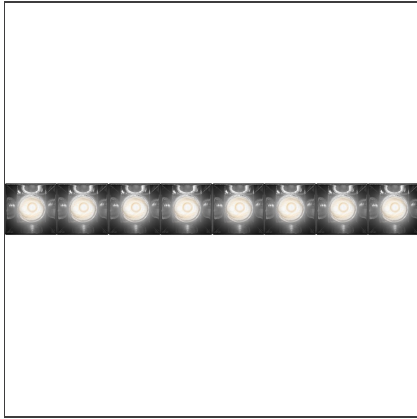

IP20  

DESIGN BY

Carlotta de Bevilacqua

DESCRIPTION

High-efficiency patented optical system that combines polynomial perspective to an element that shields geometrically the angle of vision of the beam. High uniformity of illumination and full emission control. Complete absence of possible light flaws as stains and multi-shadows. Recessed depth 60 mm. Suitable for a ceiling of 1 to 25 mm. Available in trim versions, trimless and SMD.

TECHNICAL DRAWINGS

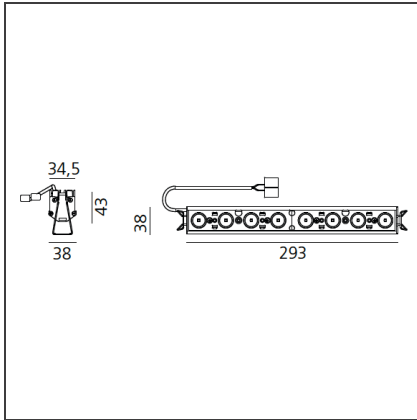

FEATURES

Article Code:	AF65000	Series:	Indoor
Colour:	Black		
Installation:	Recessed, Ceiling		
Environment:	Indoor		

DIMENSIONS

Length:	cm 29.3
Width:	cm 4.3
Height:	cm 3.8

INCLUDED SOURCES

Category:	LED	Color temperature (K):	3000K
Number:	1		
Watt:	22W		
Type:	0		
Class:	A		

LUMINAIRE

Watt:	22W	Delivered lumens output (lm):	1608lm
		CCT:	3000K
		Efficiency:	76%
		Efficacy:	73.08lm/W
		CRI:	90

ACCESSORIES



Driver 25,2 W
900mA
DV1003



Screen 4x White
AF95201



Screen 4x Black
AF95204



Driver 32 W
900mA
DV1004



Driver 40 W
900mA
DV1006

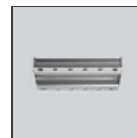

Recessed frame 8x
AF90300



Sharping wall grazer lens Kit (4pcs) - 26°x70° elliptical lenses kit. It has to be used on top of S 20° reflectors to get an elliptical beam (greter axis along the module lenght). It contains 4 lenses. AF06000