

Picto 100 LED track vertical - white 63° 4000K - Eutrac - Dimmable



IP20   Dimmerable: 

DESIGN BY

Studio Artemide

DESCRIPTION

This range of professional projectors is distinguished by design, excellent performance and flexibility. Picto is a complete and versatile range, suitable for use in retail spaces, showrooms, museums or art galleries. Available in 3 sizes, installation options, designs, colours, optics and a wide range of accessories.

TECHNICAL DRAWINGS

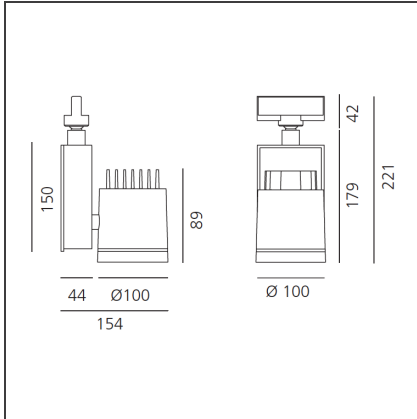

FEATURES

| | | | |
|----------------------|---------------------------|-----------------------|------------------------------|
| Article Code: | AD12601 | Material: | aluminium |
| Colour: | White | Series: | Indoor |
| Installation: | Projector, Track, Ceiling | Area contract: | Hospitality, Retail, Culture |
| Environment: | Indoor | | |

DIMENSIONS

| | | | |
|---------------------|---------|------------------------|-----|
| Length: | cm 15.4 | Glow Wire Test: | 850 |
| Height: | cm 22.1 | | |
| Weight: | kg 2.6 | | |
| Inclination: | -90+90 | | |
| Rotation: | cm 355 | | |

INCLUDED SOURCES

| | | | |
|------------------|-----|-------------------------------|-----------------|
| Category: | LED | Color temperature (K): | 4000K |
| Number: | 1 | Color Tolerance: | MacAdam 2SDCM |
| Watt: | 35W | Service Life: | L70 (6K) 50000h |
| Type: | 0 | | |
| Class: | A | | |

LUMINAIRE

| | | | |
|----------------------|--|--------------------------------------|-----------|
| Power Supply: | Power supply 220/240Vac 50/60Hz included | Delivered lumens output (lm): | 2921lm |
| | | CCT: | 4000K |
| Watt: | 35W | Efficiency: | 81% |
| | | Efficacy: | 83.45lm/W |
| | | CRI: | 90 |
| | | Dimmable Typology: | Dali |

ACCESSORIES

PICTO 100 -
Accessory-holder
+ Louvre (black).
Black
M081737



Accessory for
ceiling installation
(white)
L176320



PICTO 100 -
Accessory-holder
+ wall washer
screen (black).
Black
M082737



PICTO 100 -
Accessory-holder
(black) +
Adjustable dowser
(black)
M082637



PICTO 100 - UV-
Filter.
M080545