

Picto 100 LED track vertical - black 63° 4000K - Eutrac - Not Dimmable



IP20  

DESIGN BY

Studio Artemide

DESCRIPTION

This range of professional projectors is distinguished by design, excellent performance and flexibility. Picto is a complete and versatile range, suitable for use in retail spaces, showrooms, museums or art galleries. Available in 3 sizes, installation options, designs, colours, optics and a wide range of accessories.

TECHNICAL DRAWINGS

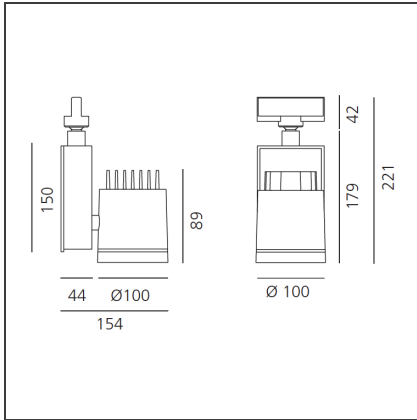

FEATURES

Article Code:	AD10604	Material:	aluminium
Colour:	black	Series:	Indoor
Installation:	Projector, Track, Ceiling	Area contract:	Hospitality, Retail, Culture
Environment:	Indoor		

DIMENSIONS

Length:	cm 15.4	Glow Wire Test:	850
Height:	cm 22.1		
Weight:	kg 2.6		
Inclination:	-90+90		
Rotation:	cm 355		

INCLUDED SOURCES

Category:	LED	Color temperature (K):	4000K
Number:	1	Color Tolerance:	MacAdam 2SDCM
Watt:	35W	Service Life:	L70 (6K) 50000h
Type:	0		
Class:	A		

LUMINAIRE

Power Supply:	Power supply 220/240Vac 50/60Hz included	Delivered lumens output (lm):	2921lm
Watt:	35W	CCT:	4000K
		Efficiency:	81%
		Efficacy:	83.45lm/W
		CRI:	90

ACCESSORIES

PICTO 100 -
Accessory-holder
+ Louvre (black).
White
M081717



Accessory for
ceiling installation
(black)
L176330



PICTO 100 -
Accessory-holder
+ wall washer
screen (black).
white
M082717



PICTO 100 -
Accessory-holder
(white) +
Adjustable dowser
(black).
M082617



PICTO 100 - UV-
Filter.
M080545