

Parabola80_round_12W_64°_3000K_Black

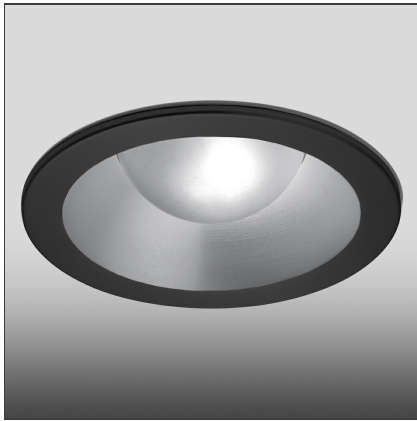

IP40 

DESIGN BY

Studio Artemide

DESCRIPTION

Light fixture with high-performance LED light sources, consists of: frame, body, lens, fixing springs. Frame in injection mould of aluminium. Heat sink body in extruded aluminium. Lens in polycarbonate with 3 different versions of beam. Fixing springs in harmonic steel. Electrical connection to the driver by means of a FEP-FEP cable and a terminal board. Technical features of light fixtures in compliance with EN60598-1.

TECHNICAL DRAWINGS

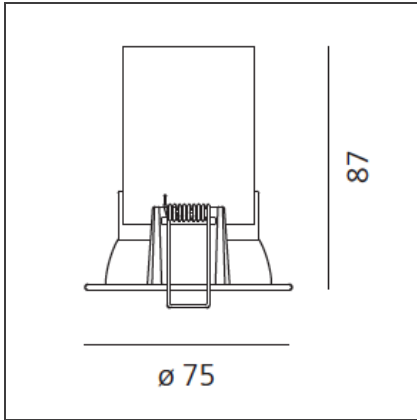

FEATURES

Article Code:	NL1906360K004	Material:	Aluminium
Colour:	Black	Series:	Indoor
Installation:	Recessed, Ceiling	Area contract:	Hospitality, null, Retail, Office, Culture, Residential
Environment:	Indoor		

DIMENSIONS

Weight:	kg 0.3	Cutout diameter:	cm 6.8
Recessed depth:	cm 8.7	Cutout shape:	Rounded

INCLUDED SOURCES

Category:	LED	Color temperature (K):	3000K
Number:	1	Color Tolerance:	3SDCM
Watt:	12W	CRI:	90
Delivered lumens output (lm):	1512lm	Efficacy:	126lm/W
Type:	0	Service Life:	L70(6K)>60000h
Class:	A		

LUMINAIRE

Power Supply:	Driver 350 mA SELV supplied separately.	Delivered lumens output (lm):	969lm
Watt:	12W	CCT:	3000K
		CRI:	90

ACCESSORIES

NO
IMAGE
AVAILABLE

ALIMENTATORE
16.8W
350/500/700MA
DALI
NL104210

NO
IMAGE
AVAILABLE

DRIVER cc 15W
350mA 220-240
125 38 23 1max
Non dimmable
M077500