

Parabola100_Round_17W_2700K_Black

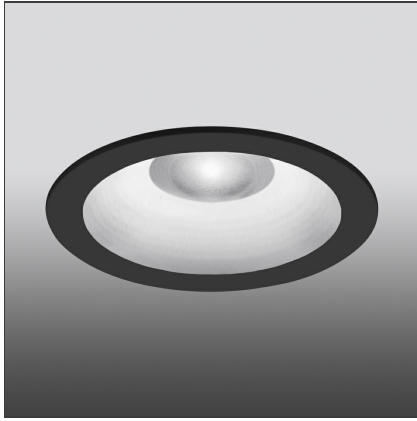

IP40  Dimmerable: 

DESIGN BY

Studio Artemide

DESCRIPTION

• Light fixture with high-performance LED light sources. • Ceiling installation. • Composed by: frame, body, lens, fixing springs. • Frame in injection mould of aluminium. • Heat sink body in extruded aluminium. • Lens in polycarbonate with 3 different versions of beam. • Fixing springs in harmonic steel. • White monochromatic LEDs available in 3 colours temperatures: Very Warm = 2700K Warm = 3000K Neutral = 4000K • Electrical connection to the driver by means of a FEP-FEP cable and a terminal board. • IP Rating IP40. • Insulation class III. • Technical features of light fixtures in compliance with EN60598-1. • Installation must be carried out by specialized personnel. • Carefully follow the instructions.

TECHNICAL DRAWINGS

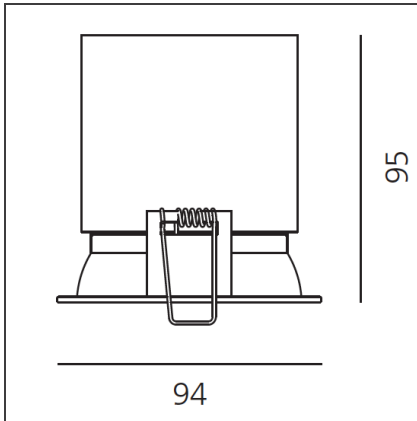

FEATURES

Article Code:	NL1907280Y004	Material:	Aluminium
Colour:	Black	Series:	Indoor
Installation:	Recessed, Ceiling	Area contract:	Hospitality, null, Retail, Office, Culture, Residential
Environment:	Indoor		

DIMENSIONS

Weight:	kg 0.5	Cutout shape:	Rounded
Recessed depth:	cm 9.5		

INCLUDED SOURCES

Category:	LED	Color temperature (K):	2700K
Number:	1	Color Tolerance:	MacAdam 3SDCM
Watt:	17W	CRI:	=90 (min.)
Delivered lumens output (lm):	2012lm	Efficacy:	118lm/W
Type:	0	Service Life:	L70(6K) > 60000h
Class:	A		

LUMINAIRE

Watt:	17W	Delivered lumens output (lm):	1372lm
		CCT:	2700K
		CRI:	90

ACCESSORIES

NO
IMAGE
AVAILABLE

Driver cc 32W
700mA DALI
dimmable
M079200

NO
IMAGE
AVAILABLE

DRIVER cc 32W
700mA 220-240
103 67 21 1max 1-
10V, push
M079300

NO
IMAGE
AVAILABLE

DRIVER cc 20W
5000mA 220-240
125 38 23 1max
Non dimmable
M077600