

Pad 80 With adjustable lenses - White - 9,5W 4000K - 40°



IP44

DESIGN BY

Carlotta de Bevilacqua

DESCRIPTION

Efficient, clear accent lighting, fixed and adjustable. 3 beam angles: 2x6°, 2x12°, 2x19°. Diffused ambient lighting (in fixed version). 2 colour temperatures: warm white (3000K) and neutral white (4000K) - CRI=80 (min.). Excellent lighting efficiency > 70lm/W. High adjustability: 360° rotation, +90°/-90° tilt angle. Fixed version available as IP44. Easy installation of light modules, no tools required. Lighting units available in 3 finishes: gloss aluminium, painted white, painted black. Structural elements of recessed-mounted version available in 3 sizes, for use with 1, 2, 3 and 2x2 modules. 3 compatible finishes (polished aluminium, white, and black). Housing of ceiling-mounted version available in 3 sizes (1, 2, 3 lighting units), and 3 compatible finishes (polished aluminium, white and black). Recessed-mounted version available as trimless or framed. Materials: body in anodized extruded aluminium, diffuser in opal polycarbonate. Complies with standard EN60598-1 and other specific standards.

TECHNICAL DRAWINGS

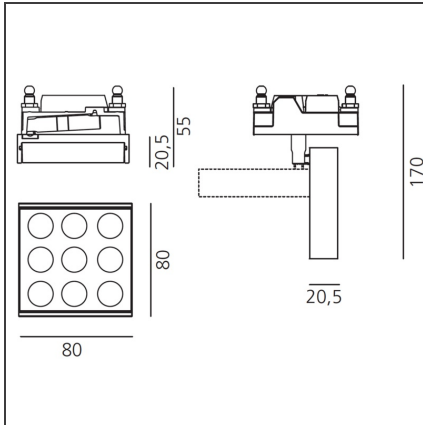

FEATURES

Article Code:	M246320	Series:	Indoor
Colour:	White	Area contract:	Hospitality, null, Retail, Culture
Installation:	Projector, Recessed		

DIMENSIONS

Length:	cm 8	Cutout shape:	Squared
Width:	cm 8	Glow Wire Test:	650
Height:	cm 17	Hole in false ceiling:	80x80 mm
Weight:	kg 0.4		
Inclination:	cm 90		
Rotation:	cm 355		
Recessed depth:	cm 5.5		

INCLUDED SOURCES

Category:	LED	Color temperature (K):	4000K
Number:	1	Color Tolerance:	MacAdam 4SDCM
Watt:	9W	CRI:	=80 (min.)
Delivered lumens output (lm):	911lm	Efficacy:	101lm/W
Type:	0	Service Life:	L70(6K) > 60500h
Class:	A		

LUMINAIRE

Watt:	9.5W	Delivered lumens output (lm):	735lm
Voltage:	12V	CCT:	4000K
		Efficiency:	100%
		Efficacy:	77.37lm/W
		CRI:	0

Notes

LED 9W 2x19° 4000K