

Pad 230V Ceiling Switchdim - 14,5W 3000K - 36°



IP40  Dimmerable: 

DESIGN BY

Carlotta de Bevilacqua

DESCRIPTION

Adjustable projector for 12x1,08W high performing LED. Body made from aluminium and translucent plastic material. White LED with Warm White or Neutral White tone. Choice of 3 beam angles. Tilt angle of up to 90°, rotation of up to 358°. Integral power supply unit. Complies with standard EN60598-1 and other specific standards. Dimming control via external push-button (not provided).

TECHNICAL DRAWINGS

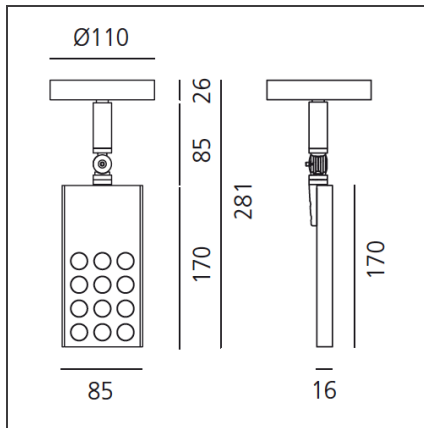

FEATURES

Article Code:	M200401	Material:	Aluminium, plastic
Colour:	Translucent/anodized	Series:	Indoor
Installation:	Projector, Track, Recessed, Ceiling	Area contract:	Retail, Culture
Environment:	Indoor	Emission:	Accent Lighting

DIMENSIONS

Length:	cm 8.5	Glow Wire Test:	650
Width:	cm 1.6		
Height:	cm 26		
Weight:	kg 0.7		
Inclination:	cm 9,090		
Rotation:	cm 358		

INCLUDED SOURCES

Category:	LED	Color temperature (K):	3000K
Number:	1	CRI:	80
Watt:	12W		
Type:	0		
Class:	A		

LUMINAIRE

Power Supply:	Electronic dimmable (Switchdim)	Delivered lumens output (lm):	805lm
Watt:	14.5W	CCT:	3000K
Voltage:	220V-240V	Efficiency:	100%
		Efficacy:	55.52lm/W
		CRI:	0

Notes

LED 13W 2x19° 3000K - Dimmerabile (Switchdim)