

Luceri LED Kadro Trimless - Comfort White Optics 4000K - Driver 50W Undimmable

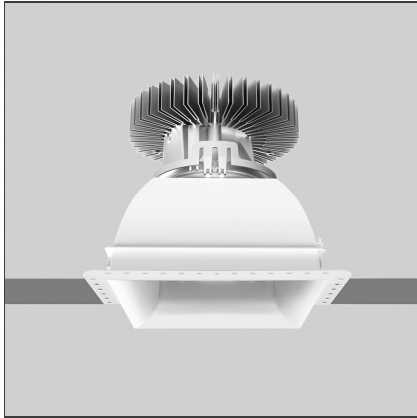

IP20/44 without screen - 20/54 with screen



TECHNICAL DRAWINGS

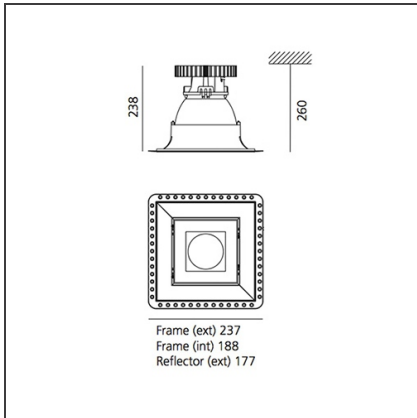

DESIGN BY

Studio Artemide

DESCRIPTION

Luceri LED and Kadro LED offer a modular range of professional downlighters, highly flexible, providing customisable lighting solutions for every need. Thanks to TrueWhite technology, colour temperature and colour rendering index are maintained constant throughout the lifespan of this product, guaranteeing a consistent light quality. The emission of versions with metal reflector is compliant with EN12464 and has UGR<19, producing an effective and comfortable lighting solution.

FEATURES

Article Code:	BB10400 DV1015	Material:	Bezel, white reflector and screens in polycarbonate, reflectors in vacuum-metalled polycarbonate with anti-scratch surface treatment.
Installation:	Recessed, Ceiling	Series:	Indoor
Environment:	Indoor	Area contract:	Hospitality, null, Office

DIMENSIONS

Length:	cm 23.7	Cutout Width:	cm 27.5
Width:	cm 23.8	Cutout length:	cm 27.5
Height:	cm 23.8	Cutout shape:	Squared
Weight:	kg 1.7		

INCLUDED SOURCES

Category:	LED	Color temperature (K):	4000K
Number:	1	CRI:	90
Watt:	max 54W		
Type:	0		

LUMINAIRE

Transformer availability:	50W	Delivered lumens output (lm):	4232lm
Watt:	54W	CCT:	4000K
		Efficiency:	73%
		Efficacy:	78.38lm/W
		CRI:	90

Notes

Driver 220/240Vac 50/60Hz supplied separately. To be completed with recessed frame.

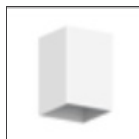
ACCESSORIES

Accessory for ceiling installation
M239920



Prismatic screen in polycarbonate
M239500



Opal screen in PMMA
M239400



Transparent screen in polycarbonate
M239300



Sharp edge trim
M240700



Support with rounded edge trim
M240800