

A.39 Suspension/Ceiling - Structural Module 2960mm - Direct Emission - 4000K - Undimmable - Black

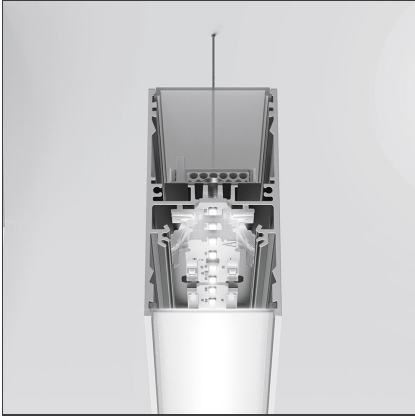

IP20 

DESIGN BY

Carlotta de Bevilacqua

DESCRIPTION

Optimized version in line applications with wide lengths. Diffusing direct and direct + indirect emission. Recessed trim, trimless, suspension and ceiling versions. Dimmable and non dimmable in two CCT 3000K and 4000K versions.

TECHNICAL DRAWINGS

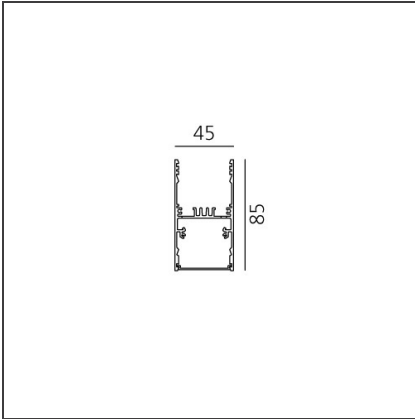

FEATURES

Article Code:	AT18304	Series:	Indoor
Colour:	Black		
Installation:	Ceiling		
Environment:	Indoor		

DIMENSIONS

Length:	cm 296
Width:	cm 4.5
Height:	cm 8.5

INCLUDED SOURCES

Category:	LED	Color temperature (K):	4000K
Number:	1		
Watt:	82W		
Type:	0		
Class:	A		

LUMINAIRE

Watt:	82W	Delivered lumens output (lm):	4944lm
		CCT:	4000K
		CRI:	80

ACCESSORIESNO
IMAGE
AVAILABLEA.39 - Mechanical
joint including 1
suspension cable
AT09500NO
IMAGE
AVAILABLEA.39 - End Cap (Kit
2x) - Black
AT09404NO
IMAGE
AVAILABLEA.39 - Ceiling
bracket and
mechanical joint
AT09501NO
IMAGE
AVAILABLEA.39 - End Ceiling
Bracket (2x)
AT09502NO
IMAGE
AVAILABLEA.39 - Opal
Diffuser in
Polycarbonate -
L=10000mm
AT10000NO
IMAGE
AVAILABLEA.39 -
Undimmable
Feeding kit
including 2
suspension cables
(3 poles) 2000mm
(H)
AT10400NO
IMAGE
AVAILABLEA.39 - Opal
Diffuser in
Polycarbonate -
L=25000mm
AT10800NO
IMAGE
AVAILABLEA.39 - Opal
Diffuser in
Polycarbonate -
L=50000mm
AT10900NO
IMAGE
AVAILABLEA.39 - Opal
Diffuser in
Polycarbonate -
L=2960mm
AT10300