

A.39 Suspension/Ceiling - Structural Module 2960mm - Direct Emission - 4000K - DALI - White

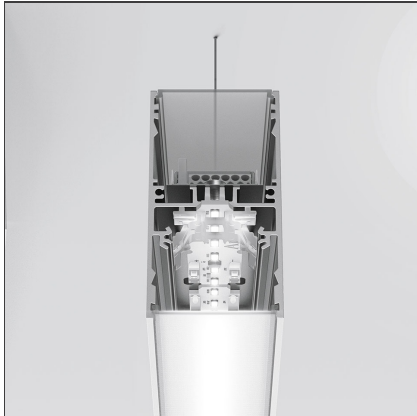

IP20  Dimmerable: 

DESIGN BY

Carlotta de Bevilacqua

DESCRIPTION

Optimized version in line applications with wide lengths. Diffusing direct and direct + indirect emission. Recessed trim, trimless, suspension and ceiling versions. Dimmable and non dimmable in two CCT 3000K and 4000K versions.

TECHNICAL DRAWINGS

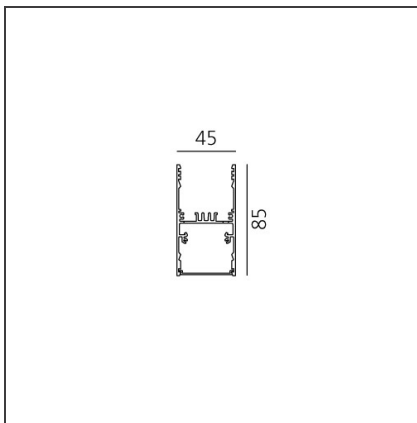

FEATURES

Article Code:	AT18201	Series:	Indoor
Colour:	White		
Installation:	Ceiling		
Environment:	Indoor		

DIMENSIONS

Length:	cm 296
Width:	cm 4.5
Height:	cm 8.5

INCLUDED SOURCES

Category:	LED	Color temperature (K):	4000K
Number:	1		
Watt:	82W		
Type:	0		
Class:	A		

LUMINAIRE

Watt:	82W	Delivered lumens output (lm):	5408lm
		CCT:	4000K
		CRI:	80
		Dimmable Typology:	Dali

ACCESSORIES

NO
IMAGE
AVAILABLE

A.39 - Mechanical joint including 1 suspension cable
AT09500

NO
IMAGE
AVAILABLE

A.39 - End Cap (Kit 2x) - White
AT09401

NO
IMAGE
AVAILABLE

A.39 - Ceiling bracket and mechanical joint
AT09501

NO
IMAGE
AVAILABLE

A.39 - End Ceiling Bracket (2x)
AT09502

NO
IMAGE
AVAILABLE

A.39 - Opal Diffuser in Polycarbonate - L=10000mm
AT10000

NO
IMAGE
AVAILABLE

A.39 - Dimmable Feeding kit including 2 suspension cables (5 poles) 2000m (H)
AT10500

NO
IMAGE
AVAILABLE

A.39 - Opal Diffuser in Polycarbonate - L=25000mm
AT10800

NO
IMAGE
AVAILABLE

A.39 - Opal Diffuser in Polycarbonate - L=50000mm
AT10900

NO
IMAGE
AVAILABLE

A.39 - Opal Diffuser in Polycarbonate - L=2960mm
AT10300