

**A.39 Suspension/Ceiling - Structural Module 1482mm - Direct Emission - 4000K - Undimmable - White**

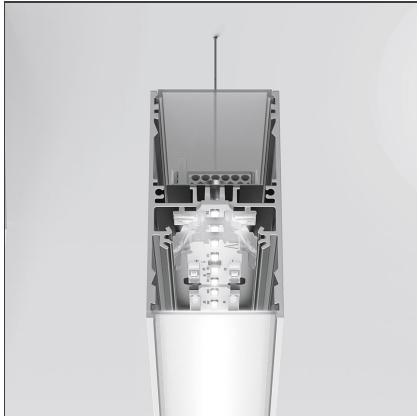

IP20 

**DESIGN BY**

Carlotta de Bevilacqua

**DESCRIPTION**

Optimized version in line applications with wide lengths. Diffusing direct and direct + indirect emission. Recessed trim, trimless, suspension and ceiling versions. Dimmable and non dimmable in two CCT 3000K and 4000K versions.

**TECHNICAL DRAWINGS**

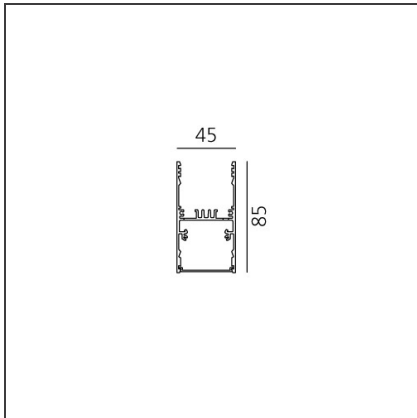

**FEATURES**

<b>Article Code:</b>	AT14301	<b>Series:</b>	Indoor
<b>Colour:</b>	White		
<b>Installation:</b>	Ceiling		
<b>Environment:</b>	Indoor		

**DIMENSIONS**

<b>Length:</b>	cm 148
<b>Width:</b>	cm 4.5
<b>Height:</b>	cm 8.5

**INCLUDED SOURCES**

<b>Category:</b>	LED	<b>Color temperature (K):</b>	4000K
<b>Number:</b>	1		
<b>Watt:</b>	42W		
<b>Type:</b>	0		
<b>Class:</b>	A		

**LUMINAIRE**

<b>Watt:</b>	42W	<b>Delivered lumens output (lm):</b>	2704lm
		<b>CCT:</b>	4000K
		<b>CRI:</b>	80

**ACCESSORIES**

NO  
IMAGE  
AVAILABLE

A.39 - Mechanical joint including 1 suspension cable  
AT09500

NO  
IMAGE  
AVAILABLE

A.39 - End Cap (Kit 2x) - White  
AT09401

NO  
IMAGE  
AVAILABLE

A.39 - Ceiling bracket and mechanical joint  
AT09501

NO  
IMAGE  
AVAILABLE

A.39 - End Ceiling Bracket (2x)  
AT09502

NO  
IMAGE  
AVAILABLE

A.39 - Opal Diffuser in Polycarbonate - L=10000mm  
AT10000

NO  
IMAGE  
AVAILABLE

A.39 - Undimmable Feeding kit including 2 suspension cables (3 poles) 2000mm (H)  
AT10400

NO  
IMAGE  
AVAILABLE

A.39 - Opal Diffuser in Polycarbonate - L=25000mm  
AT10800

NO  
IMAGE  
AVAILABLE

A.39 - Opal Diffuser in Polycarbonate - L=50000mm  
AT10900