

A.39 Recessed - Structural Module Trim 2960mm 4000K DALI Black

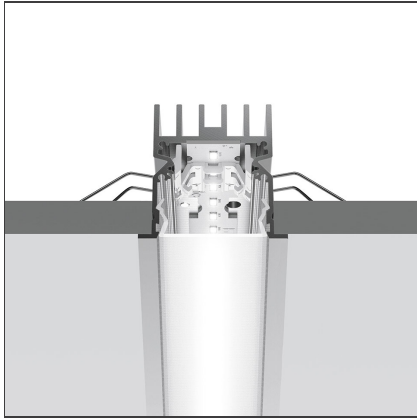

IP20  Dimmerable: 

DESIGN BY

Carlotta de Bevilacqua

DESCRIPTION

Optimized version in line applications with wide lengths. Diffusing direct and direct + indirect emission. Recessed trim, trimless, suspension and ceiling versions. Dimmable and non dimmable in two CCT 3000K and 4000K versions.

TECHNICAL DRAWINGS

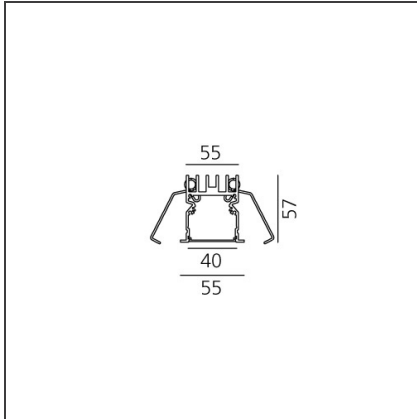

FEATURES

Article Code:	AT07104	Series:	Indoor
Colour:	Black	Emission:	Direct
Installation:	Recessed		
Environment:	Indoor		

DIMENSIONS

Length: cm 296

INCLUDED SOURCES

Category:	LED	Color temperature (K):	4000K
Number:	1		
Watt:	81W		
Type:	0		
Class:	A		

LUMINAIRE

Watt:	81W	Delivered lumens output (lm):	5247lm
		CCT:	4000K
		CRI:	80
		Dimmable Typology:	Dali

ACCESSORIES

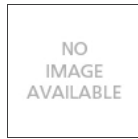

A.39 - Opal Diffuser in Polycarbonate - L=10000mm AT10000



A.39 - Opal Diffuser in Polycarbonate - L=2368mm AT10200



A.39 - Opal Diffuser in Polycarbonate - L=25000mm AT10800



A.39 - Opal Diffuser in Polycarbonate - L=2960mm AT10300



A.39 Recessed - Trimless Frame Kit - L=1488mm AT04000



A.39 Recessed - Trimless Frame Kit - L=4736mm AT04100



A.39 Recessed - Trim End Cap (Kit 2x) - Up to 5m - Black AT09004



A.39 - Opal Diffuser in Polycarbonate - L=1184mm AT10100



A.39 - Opal Diffuser in Polycarbonate - L=50000mm AT10900



A.39 Recessed - Frame Cap 2x AT09300



End Cap (x2) AT09301



A.39 Recessed - Trim End Cap (Kit 2x) - Up to 15m - Black AT09104



A.39 Recessed - Trim End Cap (Kit 2x) - Up to 35m - Black AT09204