

A.39 Recessed - Structural Module Trim 2368mm 4000K DALI Silver

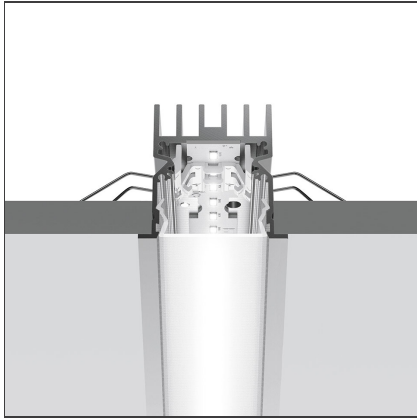

IP20  Dimmerable: 

DESIGN BY

Carlotta de Bevilacqua

DESCRIPTION

Optimized version in line applications with wide lengths. Diffusing direct and direct + indirect emission. Recessed trim, trimless, suspension and ceiling versions. Dimmable and non dimmable in two CCT 3000K and 4000K versions.

TECHNICAL DRAWINGS

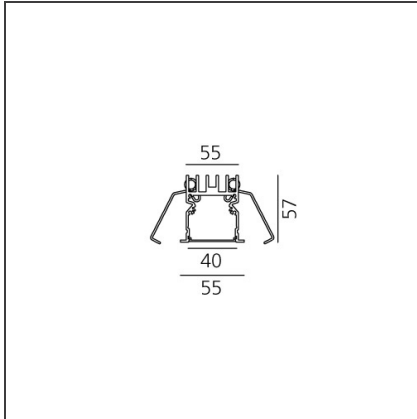

FEATURES

Article Code:	AT06205	Series:	Indoor
Colour:	Silver	Emission:	Direct
Installation:	Recessed		
Environment:	Indoor		

DIMENSIONS

Length: cm 237

INCLUDED SOURCES

Category:	LED	Color temperature (K):	4000K
Number:	1		
Watt:	63W		
Type:	0		
Class:	A		

LUMINAIRE

Watt:	63W	Delivered lumens output (lm):	4198lm
		CCT:	4000K
		CRI:	80
		Dimmable Typology:	Dali

ACCESSORIES

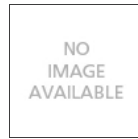

A.39 Recessed -
Trim End Cap (Kit
2x) - Up to 15m -
Silver
AT09105

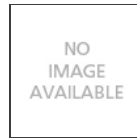

A.39 Recessed -
Trim End Cap (Kit
2x) - Up to 35m -
Silver
AT09205

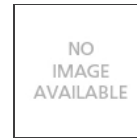

A.39 - Opal
Diffuser in
Polycarbonate -
L=10000mm
AT10000

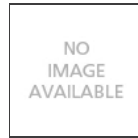

A.39 - Opal
Diffuser in
Polycarbonate -
L=2368mm
AT10200

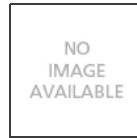

A.39 - Opal
Diffuser in
Polycarbonate -
L=25000mm
AT10800



A.39 - Opal
Diffuser in
Polycarbonate -
L=2960mm
AT10300



A.39 Recessed -
Trim End Cap (Kit
2x) - Up to 5m -
Silver
AT09005



A.39 Recessed -
Trimless Frame Kit
- L=1488mm
AT04000



A.39 Recessed -
Trimless Frame Kit
- L=4736mm
AT04100



A.39 - Opal
Diffuser in
Polycarbonate -
L=1184mm
AT10100



A.39 - Opal
Diffuser in
Polycarbonate -
L=50000mm
AT10900



A.39 Recessed -
Frame Cap 2x
AT09300



End Cap (x2)
AT09301