

## A.39 Recessed - Structural Module Trim 1776mm 4000K Undimmable White

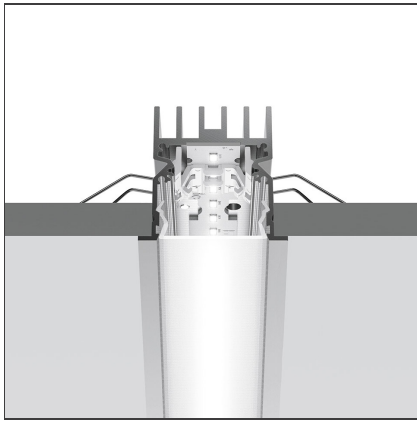

IP20 

### DESIGN BY

Carlotta de Bevilacqua

### DESCRIPTION

Optimized version in line applications with wide lengths. Diffusing direct and direct + indirect emission. Recessed trim, trimless, suspension and ceiling versions. Dimmable and non dimmable in two CCT 3000K and 4000K versions.

### TECHNICAL DRAWINGS

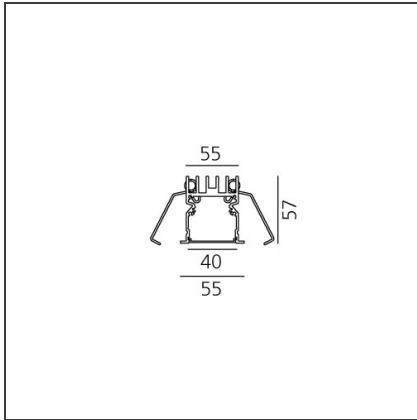

### FEATURES

<b>Article Code:</b>	AT06801	<b>Series:</b>	Indoor
<b>Colour:</b>	White	<b>Emission:</b>	Direct
<b>Installation:</b>	Recessed		
<b>Environment:</b>	Indoor		

### DIMENSIONS

**Length:** cm 178

### INCLUDED SOURCES

<b>Category:</b>	LED	<b>Color temperature (K):</b>	4000K
<b>Number:</b>	1		
<b>Watt:</b>	49W		
<b>Type:</b>	0		
<b>Class:</b>	A		

### LUMINAIRE

<b>Watt:</b>	49W	<b>Delivered lumens output (lm):</b>	3403lm
		<b>CCT:</b>	4000K
		<b>CRI:</b>	80

**ACCESSORIES**



A.39 - Opal Diffuser in Polycarbonate - L=10000mm AT10000



A.39 Recessed - Trim End Cap (Kit 2x) - Up to 5m - White AT09001

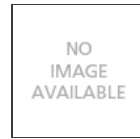

A.39 - Opal Diffuser in Polycarbonate - L=2368mm AT10200



A.39 - Opal Diffuser in Polycarbonate - L=25000mm AT10800



A.39 - Opal Diffuser in Polycarbonate - L=2960mm AT10300



A.39 Recessed - Trimless Frame Kit - L=1488mm AT04000



A.39 Recessed - Trimless Frame Kit - L=4736mm AT04100



A.39 - Opal Diffuser in Polycarbonate - L=1184mm AT10100



A.39 - Opal Diffuser in Polycarbonate - L=50000mm AT10900



A.39 Recessed - Frame Cap 2x AT09300



End Cap (x2) AT09301



A.39 Recessed - Trim End Cap (Kit 2x) - Up to 15m - White AT09101



A.39 Recessed - Trim End Cap (Kit 2x) - Up to 35m - White AT09201