

**A.39 Recessed - Structural Module Trim 1776mm 3000K Undimmable Black**

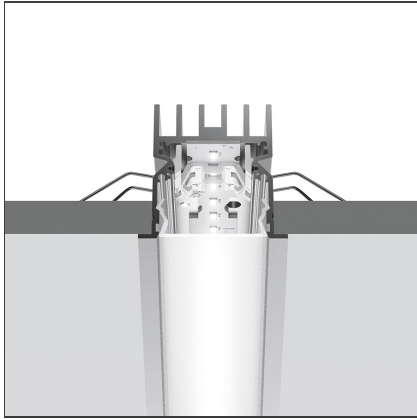

IP20 

**DESIGN BY**

Carlotta de Bevilacqua

**DESCRIPTION**

Optimized version in line applications with wide lengths. Diffusing direct and direct + indirect emission. Recessed trim, trimless, suspension and ceiling versions. Dimmable and non dimmable in two CCT 3000K and 4000K versions.

**TECHNICAL DRAWINGS**

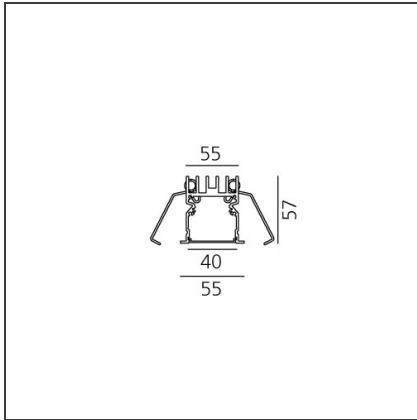

**FEATURES**

<b>Article Code:</b>	AT06504	<b>Series:</b>	Indoor
<b>Colour:</b>	Black	<b>Emission:</b>	Direct
<b>Installation:</b>	Recessed		
<b>Environment:</b>	Indoor		

**DIMENSIONS**

**Length:** cm 178

**INCLUDED SOURCES**

<b>Category:</b>	LED	<b>Color temperature (K):</b>	3000K
<b>Number:</b>	1		
<b>Watt:</b>	49W		
<b>Type:</b>	0		
<b>Class:</b>	A		

**LUMINAIRE**

<b>Watt:</b>	49W	<b>Delivered lumens output (lm):</b>	3013lm
		<b>CCT:</b>	3000K
		<b>CRI:</b>	80

**ACCESSORIES**



A.39 - Opal Diffuser in Polycarbonate - L=10000mm AT10000



A.39 - Opal Diffuser in Polycarbonate - L=2368mm AT10200



A.39 - Opal Diffuser in Polycarbonate - L=25000mm AT10800



A.39 - Opal Diffuser in Polycarbonate - L=2960mm AT10300



A.39 Recessed - Trimless Frame Kit - L=1488mm AT04000



A.39 Recessed - Trimless Frame Kit - L=4736mm AT04100



A.39 Recessed - Trim End Cap (Kit 2x) - Up to 5m - Black AT09004



A.39 - Opal Diffuser in Polycarbonate - L=1184mm AT10100



A.39 - Opal Diffuser in Polycarbonate - L=50000mm AT10900



A.39 Recessed - Frame Cap 2x AT09300



End Cap (x2) AT09301



A.39 Recessed - Trim End Cap (Kit 2x) - Up to 15m - Black AT09104



A.39 Recessed - Trim End Cap (Kit 2x) - Up to 35m - Black AT09204