

A.39 Recessed - Structural Module Trim 1482mm 4000K DALI Black

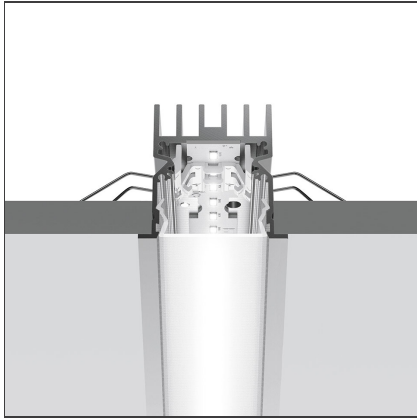

IP20  Dimmerable: 

DESIGN BY

Carlotta de Bevilacqua

DESCRIPTION

Optimized version in line applications with wide lengths. Diffusing direct and direct + indirect emission. Recessed trim, trimless, suspension and ceiling versions. Dimmable and non dimmable in two CCT 3000K and 4000K versions.

TECHNICAL DRAWINGS

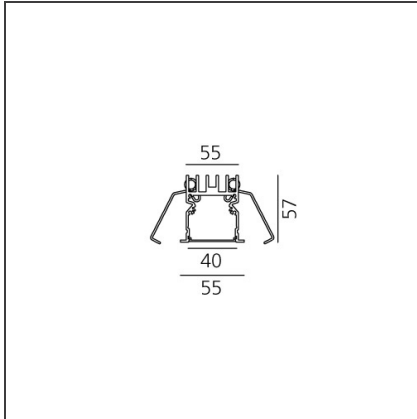

FEATURES

| | | | |
|----------------------|----------|------------------|--------|
| Article Code: | AT05604 | Series: | Indoor |
| Colour: | Black | Emission: | Direct |
| Installation: | Recessed | | |
| Environment: | Indoor | | |

DIMENSIONS

Length: cm 148

INCLUDED SOURCES

| | | | |
|------------------|-----|-------------------------------|-------|
| Category: | LED | Color temperature (K): | 4000K |
| Number: | 1 | | |
| Watt: | 41W | | |
| Type: | 0 | | |
| Class: | A | | |

LUMINAIRE

| | | | |
|--------------|-----|--------------------------------------|--------|
| Watt: | 41W | Delivered lumens output (lm): | 2624lm |
| | | CCT: | 4000K |
| | | CRI: | 80 |
| | | Dimmable Typology: | Dali |

ACCESSORIES

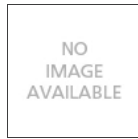

A.39 - Opal Diffuser in Polycarbonate - L=10000mm AT10000



A.39 - Opal Diffuser in Polycarbonate - L=2368mm AT10200



A.39 - Opal Diffuser in Polycarbonate - L=25000mm AT10800



A.39 - Opal Diffuser in Polycarbonate - L=2960mm AT10300



A.39 Recessed - Trimless Frame Kit - L=1488mm AT04000



A.39 Recessed - Trimless Frame Kit - L=4736mm AT04100



A.39 Recessed - Trim End Cap (Kit 2x) - Up to 5m - Black AT09004



A.39 - Opal Diffuser in Polycarbonate - L=1184mm AT10100



A.39 - Opal Diffuser in Polycarbonate - L=50000mm AT10900



A.39 Recessed - Frame Cap 2x AT09300



End Cap (x2) AT09301



A.39 Recessed - Trim End Cap (Kit 2x) - Up to 15m - Black AT09104



A.39 Recessed - Trim End Cap (Kit 2x) - Up to 35m - Black AT09204