

NAPPE N2

Design by: Marco Zito

MASIERO



Struttura in metallo verniciato con astine di metallo o diffusori in vetro. Illuminazione a LED.

Painted metal frame with metal beams or glass diffusers. LED lighting.

Lackierte Metallstruktur mit Metallstäben oder Glas-Diffusoren. LED Beleuchtung.

Structure métallique vernie avec tiges métalliques ou diffuseurs en verre. Éclairage LED.

Окрашенная металлическая структура с тонкими металлическими стержнями или стеклянными рассеивателями. Светодиодное освещение.

CE

H 40 cm / 15.74"

Ø 15 cm / 5.90"

1 x LED COB 5W 3000K 750 lm
NOT DIMMABLE

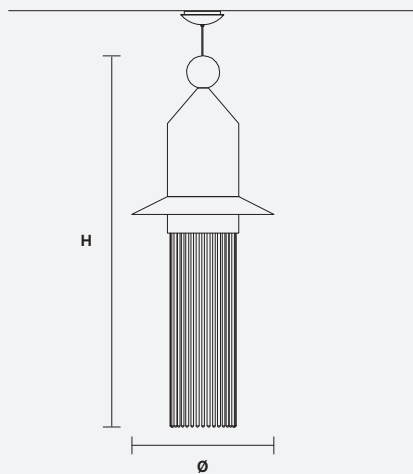

ALL WHITE

MIXED COLOURS

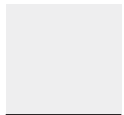

V95

V95

V21

V51

V72