

# CHIC 3

Design by: Studio Stile Masiero

# MASIERO



Struttura in metallo con inserti in fusione d'ottone e cristallo colorato.  
Pendagli in cristallo colorato.

Metal frame with cast brass and coloured crystal inserts.  
Coloured crystal pendants.

Metallstruktur mit Einsätzen aus Messingguss und farbigem Kristall.  
Behang aus farbigem Kristall.

Structure en métal avec inserts en laiton moulé et cristall coloré.  
Pampilles en cristall coloré.

Металлический каркас с литыми латунными вставками и цветным хрусталем.  
Подвесы из цветного хрусталя.



H 45 cm / 17.71"  
Ø 43 cm / 16.92"

3×G9×16 W max

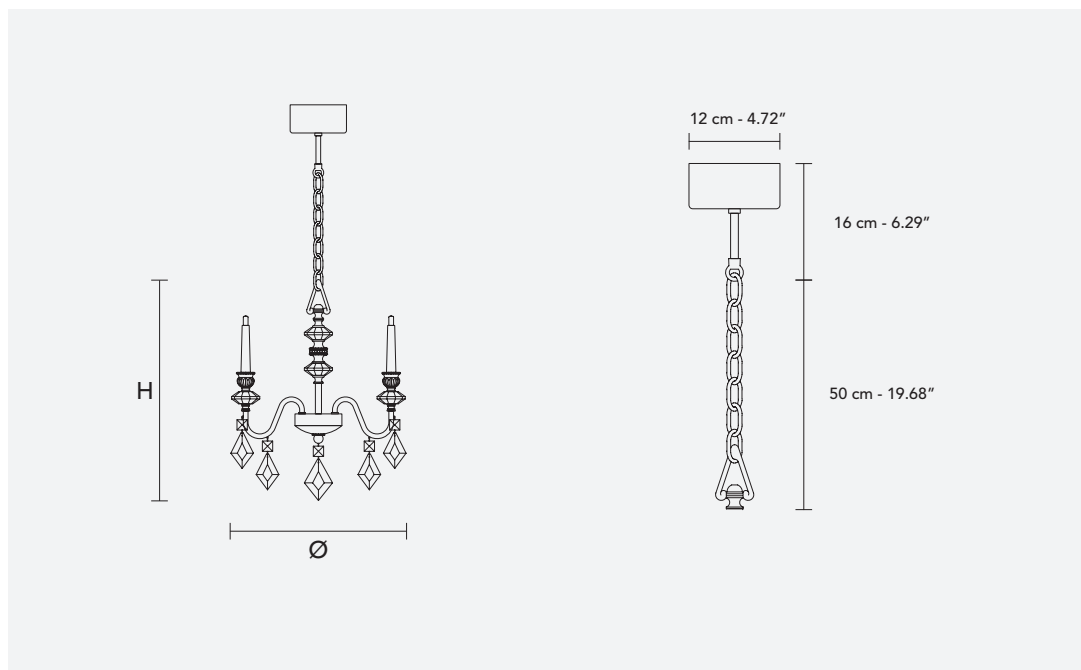

F01



F02