

# GOLDEN RING - L08101.120.0102

## Enzo Panzeri 2015

Suspension lighting fixture for interiors, with direct and indirect light emission.

Pickled sheet metal structure in polyacrylic paint.

Aluminium dissipation plates.

Aluminium and pickled sheet metal covers in matt white, black or bronze polyacrylic paint, or with gold leaf coating.

Diffusers in modelled polycarbonate with opaline finish.

Suspension kit with griplocks and 5m (196,9") long steel cables.

5m (196,9") long power cable in transparent PVC.

Power canopy with galvanized sheet metal ceiling bracket and pickled sheet metal covering in matt white, black or bronze polyacrylic paint, or with gold leaf coating.



## DATA SHEET



Code	L08101.120.0102
System power consumption	160W
Light source	LED
Light source lifetime	L80 (B20) 60'000h
Colour temperature	3000K Ra >80
Light distribution	diffused
Power supply	220-240V AC
Frequency	50/60Hz
Electrical configuration	dimnable (DALI/Push DIM)
Driver	integrated included
Nominal luminous flux	20880lm
Lumen output	11730lm
Efficiency	56.178%
Weight	15,2700Kg
Protection degree	IP40
Resistenza alla prova del filo incandescente	850°
Colour tollerances	SDCM 3
Dimensions	136 x 25 x 136

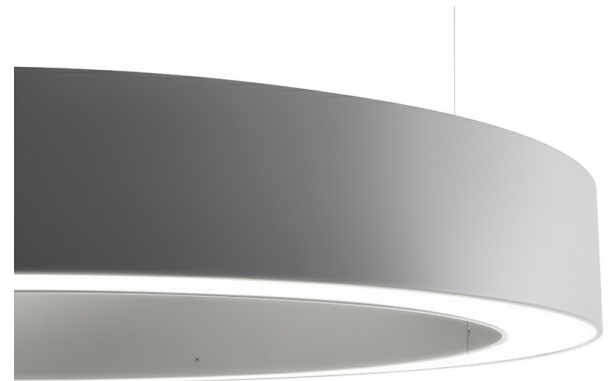

Colour

matt white



## ACCESSORIO

M8101-3 - matt white  
Canopy for power supply and to join 3 steel cables.



 TECHNICAL DRAWING

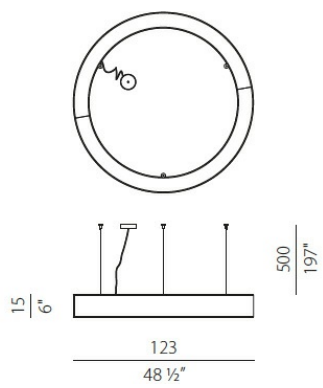

 DIAGRAMMA POLARE

