

# CLOUD (25989.25)

Manufacturer: Schmitz-Leuchten GmbH & Co. KG  
25989.25 CLOUD  
Surface: aluminium anodised  
Measurements (LxBxH): 790 x 410 x 80 mm  
light source: 2 x T16-R, 40W, 2GX13  
Control Mode: ON/OFF  
Weight: 6,2 kg  
degree of protection: IP20  
protection class: 1

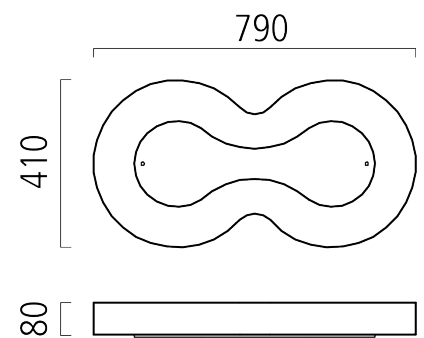

## Lighting Data

light source: 2 x T16-R, 40W, 2GX13  
Measurements (LxBxH): 790 x 410 x 80 mm  
Energy Efficiency Classification (EEC): A+,A,B

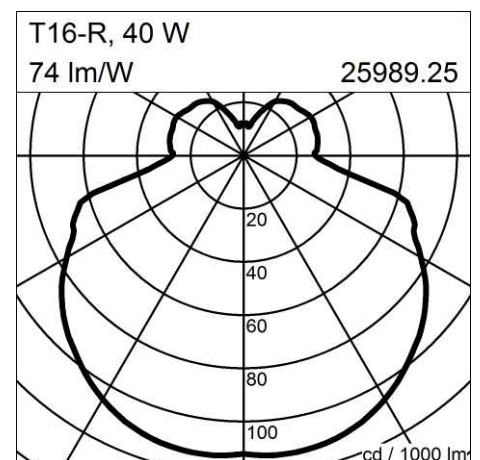

5 year warranty as specified in our terms of warranty at [www.schmitz-lighting.com/warranty](http://www.schmitz-lighting.com/warranty)

All data and information has been prepared with great care. Errors and omissions excepted. Product images are exemplary and may deviate from the original. We reserve the right improve and therefore change products at any time. © Schmitz-Leuchten GmbH & Co. KG  
Datasheet created/changed at 17.5.2016