

CLOUD (25989.252)

Manufacturer: Schmitz-Leuchten GmbH & Co. KG
25989.252 CLOUD
Surface: Aluminium eloxiert
Measurements (LxBxH): 790 x 410 x 80 mm
light source: 2 x T16-R, 40W, 2GX13
Control Mode: DIM DALI
Weight: 6,2 kg
degree of protection: IP20
protection class: 1

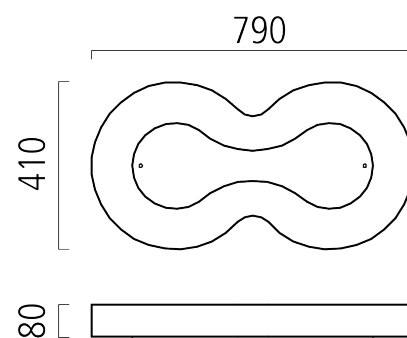

Lighting Data

light source: 2 x T16-R, 40W, 2GX13
Measurements (LxBxH): 790 x 410 x 80 mm
Energy Efficiency Classification (EEC): A,A+,B

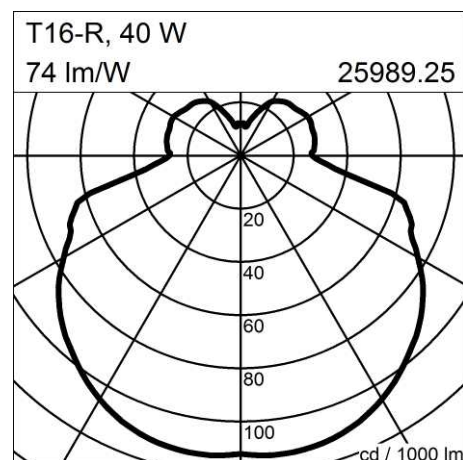

5 year warranty as specified in our terms of warranty at www.schmitz-lighting.com/warranty

All data and information has been prepared with great care. Errors and omissions excepted. Product images are exemplary and may deviate from the original. We reserve the right improve and therefore change products at any time. © Schmitz-Leuchten GmbH & Co. KG
Datasheet created/changed at 17.5.2016