

K120 ADJUSTABLE

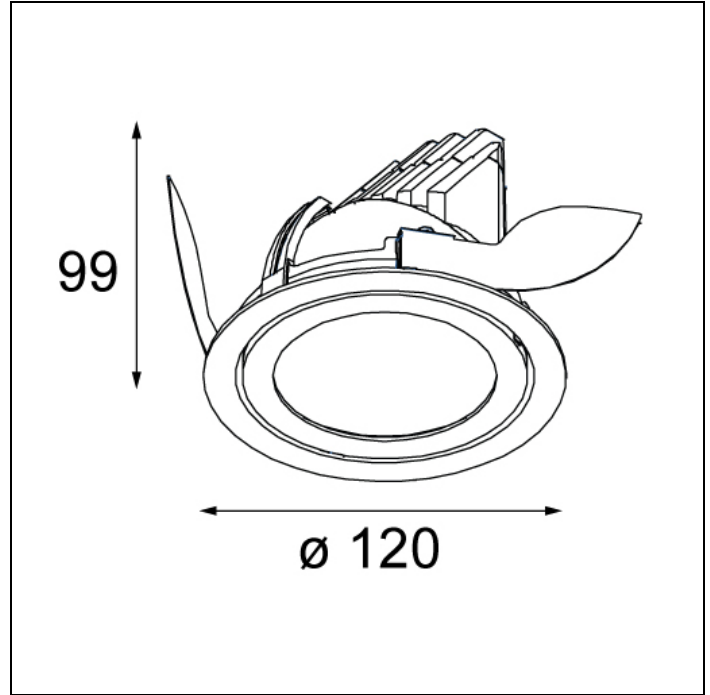
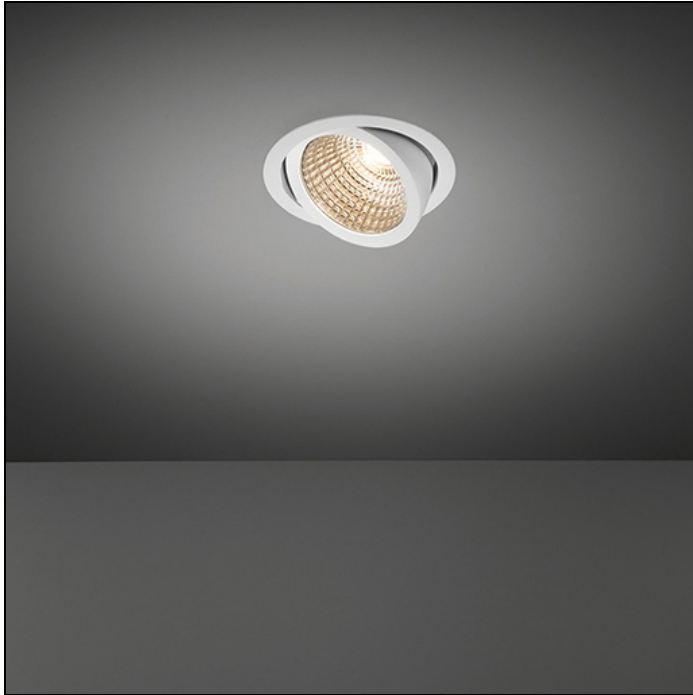

K120 ADJUSTABLE LED GE

One letter is everything this elegant, simple and versatile spotlight portfolio needs. An example of a Modular classic, round, recessed and highly-bright K spotlights are ideal for hospitality and retail environments. A 45-degree inclination enables K to offer targeted illumination, highlighting the best aspects of key products, services and areas. We're adding yet another option to this core product to offer greater lighting flexibility for larger spaces. The K120 adjustable is the latest extension, with a larger diameter that offers a higher lumen output.

Art. Nr. 13340109

SPECIFICATIONS

Lamp	1x LED Array		
Gear / Transfo	LED gear not incl.		
Cut-out size	ø 114 h 200		
Weight	0.39kg		
Min. Distance	0.1 m		
IP	IP20		
Glow Wire Test	960°		
Lifetime	L80 B20 @ 50.000 hrs		
CRI	90		
Power supply	350mA	500mA	700mA
	33.3Vf	34.3Vf	35.7Vf
Connected load	11.7W	17.2W	25W
Lumen	1238lm	1679lm	2198lm
Efficacy	106lm/W	98lm/W	88lm/W
UGR	20	21	22
Adjustability	h 359° v 45°		
Remark	! 3500K on request		

	WARM WHITE 2700K / CRI 90+			WARM WHITE 3000K / CRI 90+			NEUTRAL WHITE 4000K / CRI 90+		
	SPOT 15°	MEDIUM 25°	FLOOD 40°	SPOT 15°	MEDIUM 25°	FLOOD 40°	SPOT 15°	MEDIUM 25°	FLOOD 40°
black struc	13340032	13340132	13340232	13341032	13341132	13341232	13342032	13342132	13342232
donkey grey struc	13340071	13340171	13340271	13341071	13341171	13341271	13342071	13342171	13342271
white struc	13340009	13340109	13340209	13341009	13341109	13341209	13342009	13342109	13342209

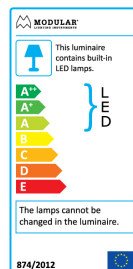

This label is available in other languages:
<http://supermodular.com/assets/TYPE2.pdf>



K120 ADJUSTABLE LED GE

ACCESSORIES

LENSES

10216903 | SPREADLENS Ø80

ANTIGLARE

10212802 | HONEYCOMB Ø80 BLACK
10217002 | CROSS BLADE Ø80 BLACK

HUE-MODULE

13190030 | MODULAR CONNECTED 1-10V WHITE COMPONENT

HUE-BRIDGE

70000616 | PHILIPS HUE BRIDGE EU
70000617 | PHILIPS HUE BRIDGE UK

HUE-DEVICE

70000614 | PHILIPS HUE DIMMER SWITCH
70000615 | PHILIPS HUE TAP SWITCH
70000847 | PHILIPS HUE SENSOR

