

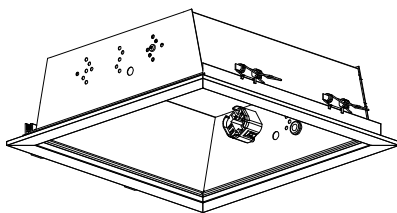



67-003H-**** 2x / 3x 26W (TC-D / TC-DEL)
 2x / 3x 32W (TC-TEL)
 2x / 3x 42W (TC-TEL)



 s = 312 x 312 mm

1.

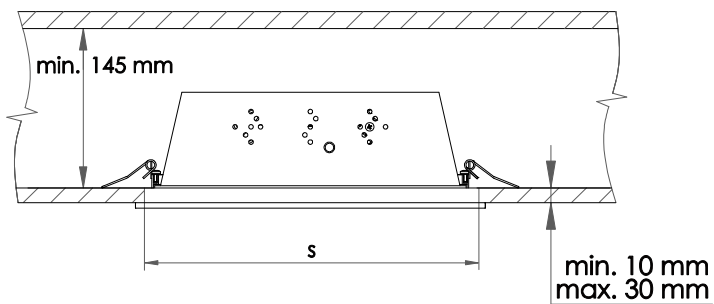
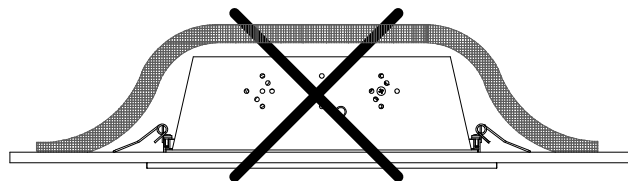
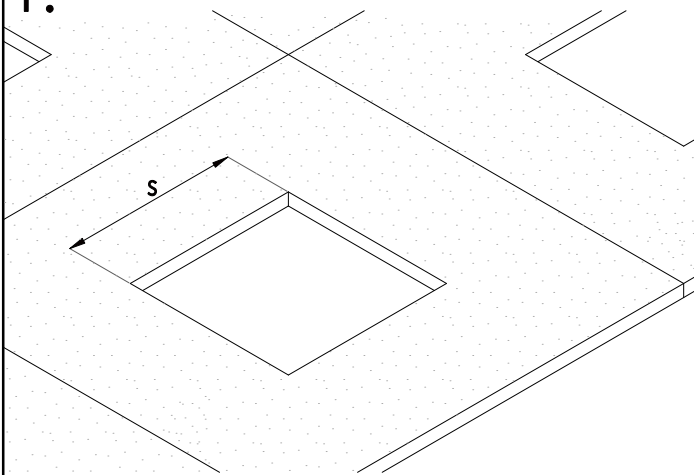
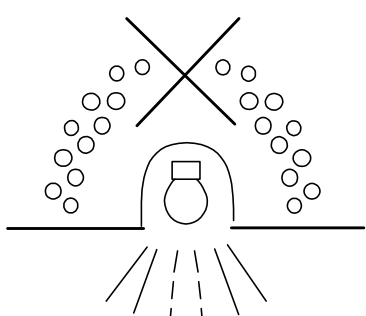

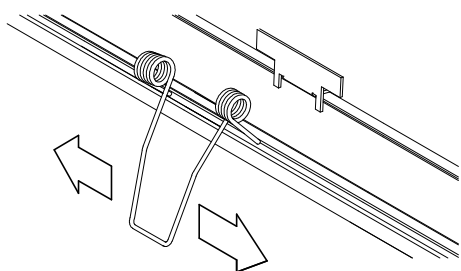

- Nepřekrývat svítidlo izolačním materiálem !
- Luminaire must not be covered with insulating material !
- Die Leuchte nicht mit Isoliermaterial überdecken !
- Не перекрывать светильник изоляционным материалом !

2.

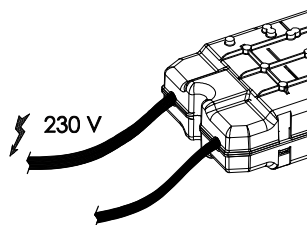
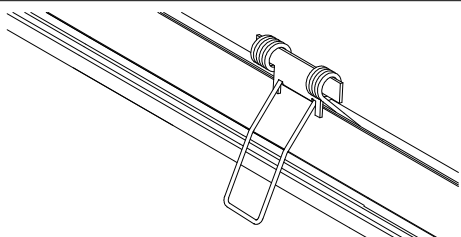
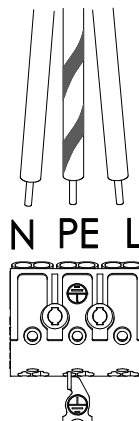
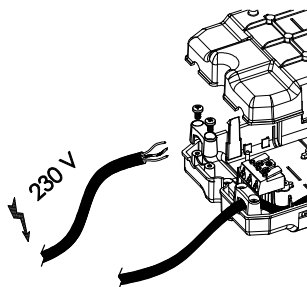

3.



4.

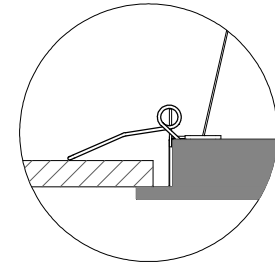
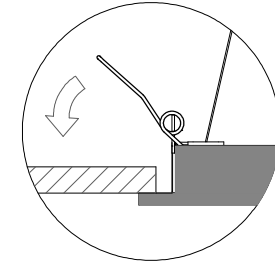
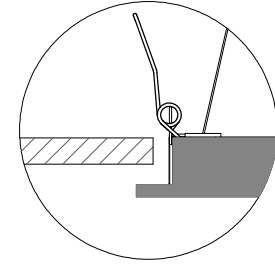
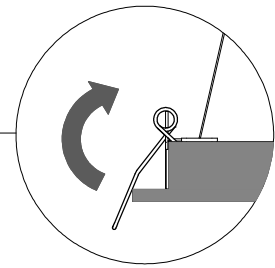
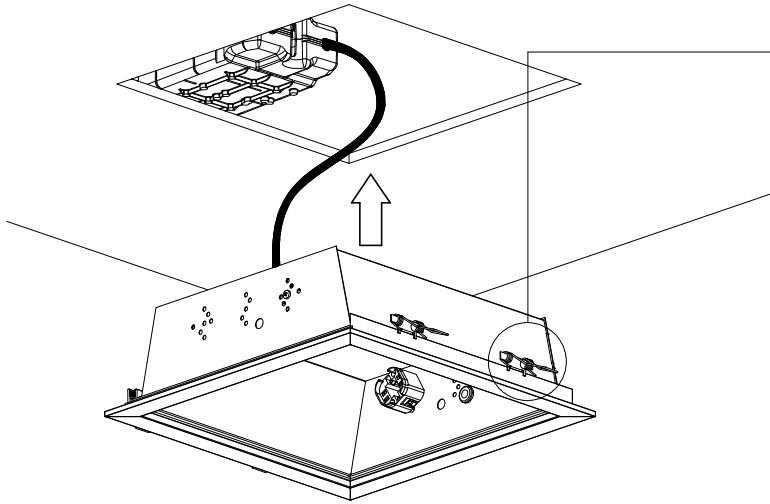

5.

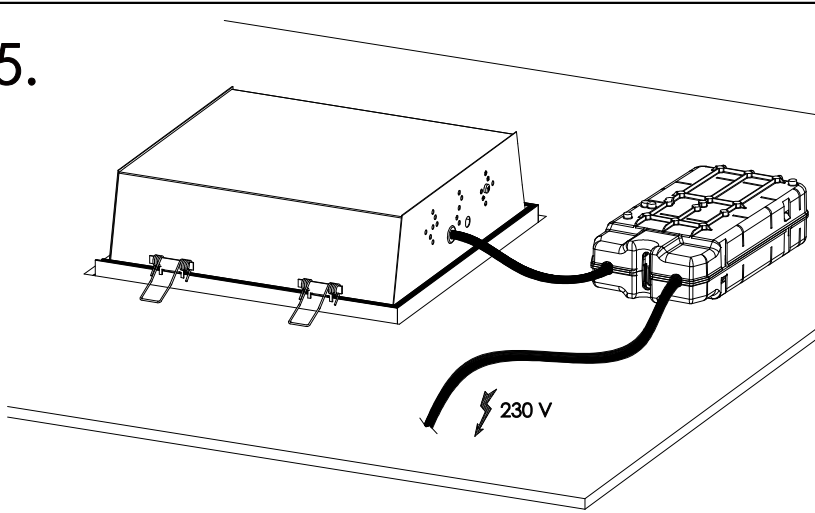

6.

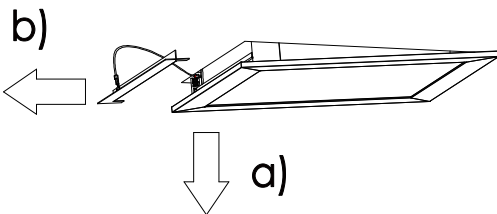

7.

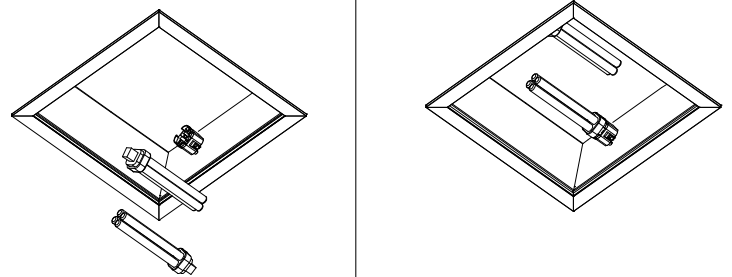

8.

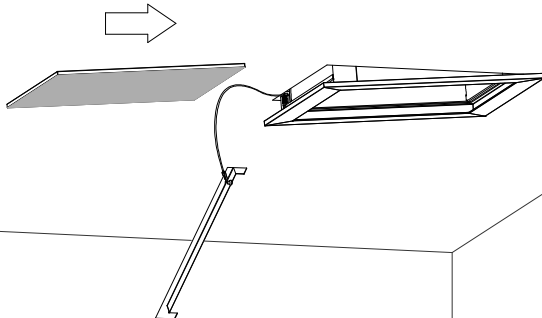

9.

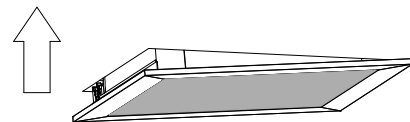

- Montáž smí provádět pouze pracovník s odbornou elektrotechnickou kvalifikací. Před prováděním jakékoliv údržby vypněte přívod el. proudu.
- The installation may only be carried by authorised specialist. Always switch-off the power supply before carrying out any maintenance.
- Die Leuchtenmontage kann nur von autorisiertem Fachpersonal durchgeführt werden. Vor der beliebigen Wartungsausführung die Einspeisung abschalten.
- Установка светильников разрешена только квалифицированным электромонтером. Перед любым ремонтом или уходом за светильником необходимо выключить питание.
- Výrobce nenese odpovědnost za nesprávné zacházení s produkty.
- The manufacturer is not responsible for the incorrect use and assembly of its products.
- Der Hersteller trägt keine Verantwortung für eine falsche Verwendung des Produktes.
- Производитель не несет ответственности за неправильное обращение с продуктом.