

THE REFLEX LED COB FISSI/WALL WASHER



MINIMAL
78/104/134/152



FRAME
75/96/125/153/212/242



I ATTENZIONE:

LA SICUREZZA DELL'APPARECCHIO E' GARANTITA SOLO CON L'USO APPROPRIATO DELLE SEGUENTI ISTRUZIONI; PERTANTO E' NECESSARIO CONSERVARLE.

GB WARNING:

THE SAFETY OF THIS FIXTURE IS GUARANTEED ONLY IF YOU COMPLY WITH THESE INSTRUCTIONS; REMEMBER TO CONSERVE IN A SAFE PLACE.

F ATTENTION:

LA SECURITE DE L'APPAREIL N'EST GARANTIE QU'EN CAS D'UTILISATION CORRECTE DES INSTRUCTIONS SUIVANTES; IL FAUT PAR CONSEQUENT LES CONSERVER.

D ACHTUNG:

DIE SICHERHEIT DES GERÄTES WIRD NUR DURCH SACHGEMÄSSE BEFOLGUNG NACHSTEHENDER ANWEISUNGEN GEWÄHRLEISTET; IHRE AUFBEWAHRUNG IST DESHALB SEHR WICHTIG.

NL OPGELET:

DE VEILIGHEID VAN DI ATOESTEL IS SLECHTS DAN GEGARANDEERD ALS INDIEN DE VOLGENDE INSTRUCTIES STRIKT WORDEN TOEGEPAST; DAAROM MOET MEN ZE OOK BEWAREN.

E ATENCION:

LA SEGURIDAD DEL APARATO SE GARANTIZA SOLO CUMPLIENDO CUIDADOSAMENTE LAS SIGUIENTES INSTRUCCIONES; POR ELLO, ES NECESARIO CONSERVARLAS.

DK BEMÆRK:

SIKKERHEDEN VED BRUG AF ARMATURET KAN KUN GARANTERES, HVIS DISSE ANVISNINGER FØLGES; SØRG DERFOR FOR AT GEMME DEM.

N ADVARSEL:

SIKKERHETEN TIL DETTE APPARATET GARANTERES KUN HVIS DU OVERHOLDER DISSE INSTRUKSJONENE; HUSK Å OPPBEVARE DEM PÅ ET TRYGT STED.

S OBSERVERA!

UTRUSTNINGENS SÄKERHET KAN ENDAST GARANTERAS OM DESSA ANVISNINGAR RESPEKTERAS I DETALJ. SPARA DÄRFÖR DESSA ANVISNINGAR FÖR FRAMTIDA KONSULTATION.

RUS ВНИМАНИЕ:

МЫ ГАРАНТИРУЕМ БЕЗОПАСНУЮ ЭКСПЛУАТАЦИЮ ИЗДЕЛИЯ ТОЛЬКО ПРИ СОБЛЮДЕНИИ СЛЕДУЮЩИХ ИНСТРУКЦИЙ; С ЭТОЙ ЦЕЛЬЮ НЕОБХОДИМО СОХРАНИТЬ ДАННУЮ БРОШЮРУ.

CN 警告

为确保该装置安全，请遵守操作指示；并于安全场所放置。



N.B.: DURANTE L'INSTALLAZIONE DEL SISTEMA RISPETTARE SCRUPolosAMENTE LE NORME IMPIANTISTICHE NAZIONALI VIGENTI.

N.B.: WHEN INSTALLING THE SYSTEM, MAKE SURE ALL CURRENT NATIONAL REGULATIONS RELATING TO INSTALLATION ARE OBSERVED.

N.B.: LORS DE L'INSTALLATION DU SYSTÈME VEUILLEZ RESPECTER RIGOREUSEMENT LES NORMES EN VIGUEUR EN LA MATIÈRE DANS LE PAYS.

N.B.: BEACHTEN SIE BEI DER INSTALLATION DES SYSTEMS UNBEDINGT DIE IM LAND GELTENDEN ANLAGETECHNISCHEN VORSCHRIFTEN.

N.B.: BIJ HET INSTALLEREN VAN HET SYSTEEM MOET U DE GELDENDE NATIONALE INSTALLATIENORMEN STRIKT NALEVEN.

NOTA: DURANTE LA INSTALACIÓN DEL SISTEMA RESPETAR ESCRUPolosAMENTE LAS NORMAS NACIONALES DE INSTALACIÓN EN VIGOR.

N.B.: UNDER INSTALLATION AF SYSTEMET SKAL MAN NØJE OVERHOLDE DE GÆLDENDE REGLER FOR DISSE ANLÆG.

N.B.: UNDER INSTALLASJON AV SYSTEMET MÅ DE NASJONALE ANLEGGSFORSKRIFTE NE OVERHOLDES NØYE.

OBS! UNDER INSTALLATIONEN AV SYSTEMET SKA GÄLLANDE NATIONELLA INSTALLATIONSFÖRESKRIFTER RESPEKTERAS I DETALJ.

ПРИМЕЧАНИЕ: В ПРОЦЕССЕ МОНТАЖА СИСТЕМЫ СТРОГО СОБЛЮДАЙТЕ НАЦИОНАЛЬНЫЕ ДЕЙСТВУЮЩИЕ НОРМАТИВЫ ПО ЭЛЕКТРОПРОВОДКЕ.

注意：安装系统时请务必遵守系统标准。



| Ø | ART. | X max mm | Y max mm |
|-----|---|----------|----------|
| 96 | N121-N122-N123-N124-N125-Q978 | 850 | 900 |
| 125 | N111 - N112 - N113 - N114 - N115 N239 - N240 - N241 - N242 - N243 N244 - N245 - N246 - N247 - N248 N126 - N127 - N128 - N129 - N130 Q979-Q980-Q981-Q982 | | |
| 153 | N116 - N117 - N118 - N119 - N120 N131 - N132 - N133 - N134 - N135 Q983-Q984 | 1000 | 1150 |
| 212 | MN01 - MN02 - MN03 - MN04 - N136 | 1100 | 1200 |





- I N.B.: Apparecchi non idonei ad essere coperti di materiale termicamente isolante.
- GB N.B.: Fixtures not suitable to be covered in thermally-insulating material.
- F N.B.: Appareils ne pouvant pas être couverts de matériau d'isolation thermique.
- D N.B.: Geräte nicht geeignet, um mit wärmeisolierendem Material abgedeckt zu werden.
- NL N.B.: Deze apparaten zijn niet geschikt om te worden bedekt met thermisch isolerend materiaal.
- E NOTA: Aparatos no aptos para ser cubiertos de material térmicamente aislante.
- DK N.B.: Armaturerne må ikke dækkes af varmeisolerende materiale.
- N N.B.: Apparaten passer ikke til å dekkes av termoisolerende materialer.
- S OBS! Utrustningen får inte täckas över med värmeisolerande material.
- RUS Приборы, непригодные для покрытия термоизоляционным материалом.
- CN 灯具不适宜用隔热材料加以覆盖!

Art. MV78-MV79-MV80-MV81-MV82-MV83-MV84-MV85-MV86-MV87
 MV88-MV89-MV90-MV91-MV92-MV93-MV94-MV95-MV96-MV97
 MV98-MV99-N000-N001-N002-N003-N004-N005-N229-N230-N231
 N232-N233-N234-N235-N236-N237-N238-N006-N007-N008-N009
 N010-N011-N012-N013-N014-N015-N224-MM97-M225-MM98-N226
 MM99-N227-MN00-N228-N016-M636-P586-P587-P588-P589-P507-
 P508-P509-P510-P511-P512-P513-P514-P515-P516-P517-P518
 P519-P520-P521-P522-P523-P524-P525-P526-P527-P528-P529-P530
 P531-P532-P533-Q959-Q960-Q961-Q964-Q965-Q966-Q967-Q968-Q969
 Q974-Q975



Art. N017-N018-N019-N020-N021-N022-N023-N024



Art. MV40-MV41-MV42-MV43-MV44-MV45-MV46-MV47-MV48-MV49
 MV50-MV51-MV52-MV53-MV54-MV55-MV56-MV57-N121-N122-N123
 N124-N125-MV58-MV59-MV60-MV61-MV62-MV63-MV64-MV65-MV66
 MV67-N111-N112-N113-N114-N115 N214-N215-N216-N217-N218
 N219-N220-N221-N222-N223-N239-N240-N241-N242-N243-N244-N245
 N246-N247-N248-MV68-MV69-MV70-MV71-MV72-MV73-MV74-MV75
 MV76-MV77-N116-N117-N118-N119-N120-N131-N132-N133-N134
 N135-MN01-MN02-MN03-MN04-N136
 Q962-Q963-Q970-Q971-Q972-Q973-Q976-Q977



Frame

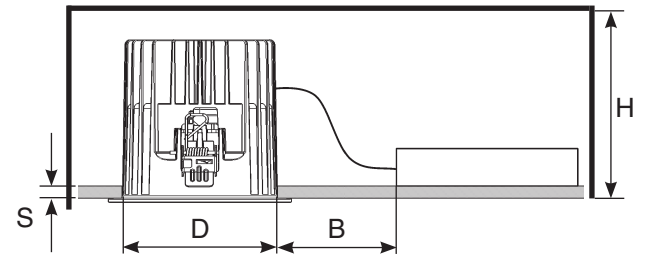
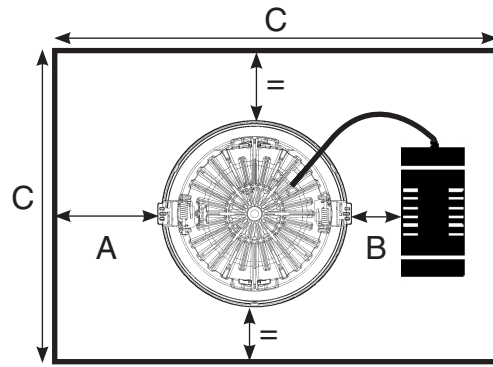

Minimal

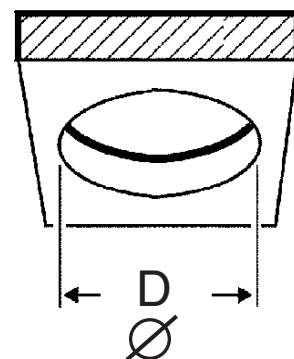
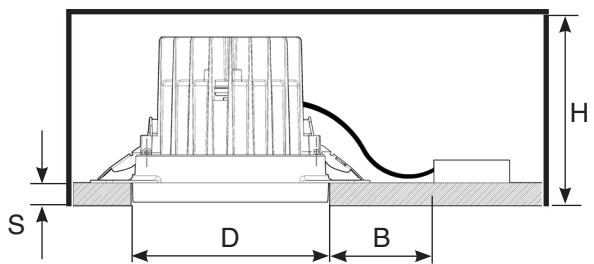
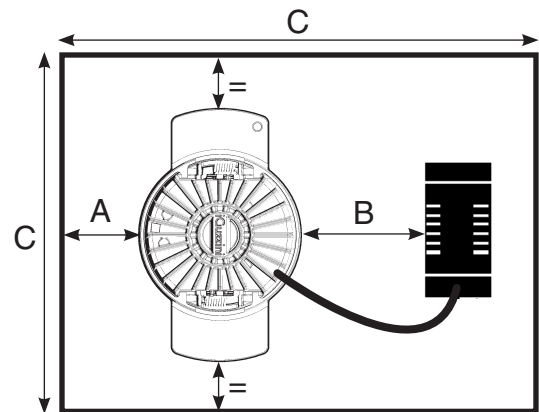

| ART. | ∅ D mm | S mm | H mm | A mm | B mm | C mm |
|---|---------------------|---------|---------|---------|---------|---------|
| MV40-MV41-MV42-MV43 MV44-MV45-MV46-MV47 | 78 ^{±1} | 12,5 | 100 | 50 | 100 | 350 |
| MV78-MV79-MV80-MV81-P586-P587 MV82-MV83-MV84-MV85-P588-P589 | 75 ⁺²⁻⁰ | 1±20 | 100 | | 100 | 350 |
| MV48-MV49-MV50-MV51- MV52 MV53-MV54-MV55-MV56-MV57 Q962-Q963 | 104 ^{±1} | 12,5 | 100 | | 100 | 350 |
| MV86-MV87-MV88-MV89-MV90-P507 MV91-MV92-MV93-MV94-MV95-P508 N121-N122-N123-N124-N125-P509-P510 Q959-Q960-Q961-Q978 | 96 ⁺²⁻⁰ | 1±20 | 100 | | 100 | 350 |
| MV58-MV59-MV60-MV61-MV62 MV63-MV64-MV65-MV66-MV67 N111-N112-N113-N114-N115-N214 N215-N216-N21-N218-N219-N220 N221-N222-N223-N239-N240 N241-N242-N243 Q970-Q971-Q972-Q973-Q981-Q982 | 134 ^{±1} | 12,5 | 111 | | 100 | 350 |
| MV96-MV97-MV98-MV99-N000-P511 N001-N002-N003-N004-N005-N126 N127-N128-N129-N130-N229-N230 N231-N232-N233-N234-N235-N236 N237-N238-N244-N245-P512-P513 N246-N247-N248-P514-P515-P516 P517-P518 - P523 - P524 - P525 P526-P527-P528-Q964-Q965-Q966-Q967 Q968-Q969-Q979-Q980 | 125 ⁺²⁻⁰ | 1±20 | 109 | | 100 | 350 |
| MV68-MV69-MV70-MV71-MV72 MV73-MV74-MV75-MV76-MV77 N116-N117-N118-N119-N120 Q976-Q977-Q984 | 152 ^{±1} | 12,5 | 125 | | 100 | 500 |
| N006-N007-N008-N009-N010-N011 N012-N013-N014-N015-N131-N132 N133-N134-N135 Q974-Q975-Q983 | 153 ⁺²⁻⁰ | 1±25 | 123 | | 100 | 500 |
| N224-N225-N226-N227-P519-P520 MM97-MM98-MM99-MN00-P521 MN01-MN02-MN03-MN04-P522 | 212 ⁺²⁻⁰ | 1±25 | 150 | | 150 | 600 |
| N228-N016 - M636-N136-P529 P530-P531-P532-P533 | 212 ⁺²⁻⁰ | 1±25 | 190 | | 150 | 600 |
| N017-N018-N019-N020 N021-N022-N023-N024 | 242 ⁺²⁻⁰ | 1±25 | 250 | 150 | 600 | |

96 / 125 / 153 / 212
104 / 134 / 152

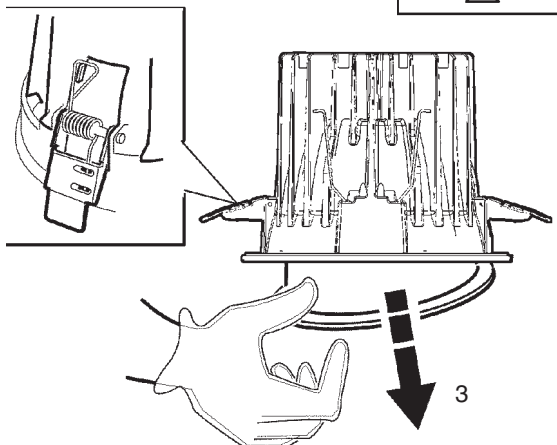

∅ 75/78



∅ 242

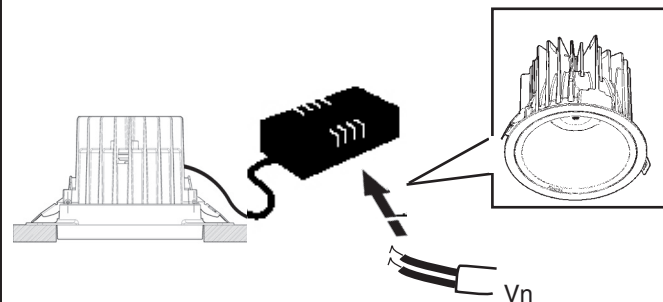
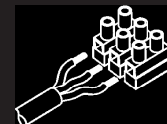
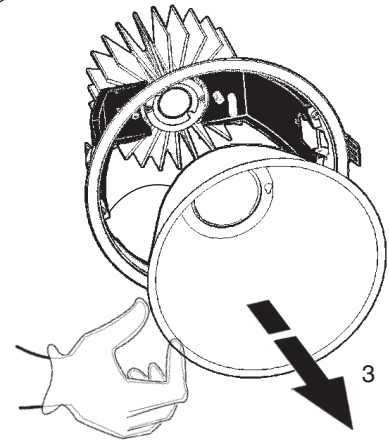
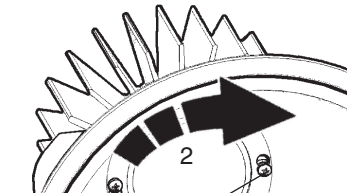
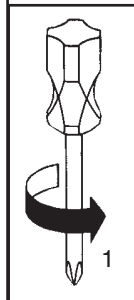



- I Per il collegamento elettrico fare riferimento alla marcatura dell'alimentatore.
 GB Refer to the marking on the power unit for the electrical connection.
 F Pour le raccordement électrique se reporter au marquage du ballast.
 D Den Anschluss an das Stromnetz gemäß Kennzeichnung auf dem Vorschaltgerät ausführen.
 NL Voor de elektrische aansluiting wordt verwezen naar de markering op de stroomvoorziening.
 E Para la conexión eléctrica hacer referencia a las informaciones marcadas en el alimentador.
 DK For elektrisk tilslutning, se strømforsynings mærkning.
 N For elektrisk tilkobling, se merking på strømforsyningsenheten.
 S För elanslutningen se till märkningarna på nätdelen.
 RUS Для электрического подключения смотреть маркировку на блоке питания.
 CN 连接电线时请参照供电装置上的标记。

| | S mm ² | Y mm | X mm | D mm |
|---------------------------|-------------------|-----------|------|---------|
| * TCI DC MAXI JOLLY | 0,5 - 2,5 | 6 ± 0,5 | | 3 - 8 |
| OSRAM OT Fit | | 9 ± 0,5 | ~ 30 | / |
| OSRAM OT i DALI | 0,5 - 1,5 | 8 - 9 | | 7 - 11 |
| PHILIPS Xitanium LH | | 9 ± 0,5 | ~ 25 | / |
| PHILIPS Xitanium / m | 0,2 - 1,5 | 8,5 - 9,5 | | / |
| PHILIPS SH | 0,75 - 2,5 | 10 - 11 | ~ 40 | |
| TRIDONIC LCAI - LCI | 0,5 - 2,5 | | ~ 30 | 10 - 11 |
| TRIDONIC LC | | 8,5 - 9,5 | ~ 40 | / |
| OSRAM OTe 35 | 0,5 - 1,5 | 8 - 9 | ~ 30 | / |

- I Pilotare diversi prodotti DALI tramite pulsante (es: Touch-dim, Switch-dim, Push-dim, Direct-dim, etc.) potrebbe causare dei problemi di sincronizzazione tra gli stessi. È possibile ovviare a questo problema dotandosi di dispositivi aggiuntivi. Per maggiori informazioni vi invitiamo a contattarci direttamente.
 GB Controlling different DALI products through buttons (e.g.: Touch-dim, Switch-dim, Push-dim, Direct-dim, etc.) may lead to product synchronisation problems. This problem can be overcome by using additional devices. For further information, please contact us directly.
 F Piloter plusieurs produits DALI par bouton (ex : Touch-dim, Switch-dim, Push-dim, Direct-dim, etc.) pourrait causer des problèmes de synchronisation entre eux. Ce problème peut être évité en s'équipant de dispositifs supplémentaires. Pour de plus amples renseignements, veuillez nous contacter directement.
 D Die Steuerung verschiedener DALI-Produkte mittels Taste (z.B.: Touch-dim, Switch-dim, Push-dim, Direct-dim etc.) kann eventuell zu Synchronisierungsproblemen zwischen diesen führen. Dieses Problem lässt sich durch den Einsatz von zusätzlichen Geräten beheben. Wenn Sie weitere Informationen wünschen, setzen Sie sich bitte direkt mit uns in Verbindung.
 NL Het besturen van verschillende DALI producten m.b.v. dezelfde knop (bv.: Touch-dim, Switch-dim, Push-dim, Direct-dim, etc.) kan synchronisatieproblemen tussen de producten opleveren. Men kan dit probleem voorkomen door extra systemen aan te sluiten. Voor verdere informatie raden we u aan direct contact met ons op te nemen.
 E El mando de varios productos DALI por tecla (ej: Touch-dim, Switch-dim, Push-dim, Direct-dim, etc.) podría causar problemas de sincronización entre ellos. Es posible prevenir este problema utilizando dispositivos adicionales. Para más información, contacte directamente con nosotros.
 DK Hvis DALI-produkterne styres ved hjælp af knapperne (fx. Touch-dim, Switch-dim, Push-dim, Direct-dim osv.), kan det skabe problemer med synkronisering af samme. Dette problem kan undgås, hvis man køber ekstra enheder. For yderligere oplysninger, kontakt os direkte.
 N Å styre ulike DALI-produkter ved hjelp av en trykknappbryter (f.eks. touch-dim, switch-dim, push-dim, direct-dim, osv.) vil kunne føre til problemer med synkroniseringen mellom dem. Dette problemet kan løses ved hjelp av noen tilleggsinnretninger. Ta gjerne kontakt med oss for mer informasjon om dette.
 S Styning av olika DALI-produkter med knapp (f.ex.: Touch-dim, Switch-dim, Push-dim, Direct-dim o.s.v.) kan orsaka synkroniseringsproblem mellan dessa. Detta problem kan åtgärdas med tillägsanordningar. För mer information kan du kontakta oss direkt.
 RUS Управление различными продуктами DALI с помощью кнопки (напр.: Touch-dim, Switch-dim, Push-dim, Direct-dim и пр.) может вызвать проблемы синхронизации между ними. Эту проблему можно устранить путем задействования дополнительных устройств. За получением более подробной информации просим Вас связаться с нами непосредственно.
 CN 通过按钮控制不同的 DALI 产品 (例如: 触摸调光、切换调光、按压调光、直接调光等) 可能会导致产品的同步问题。该问题可通过使用其他额外的装置加以克服。如需了解更多信息, 请直接与我们联系。

DALI



SWITCH DIM / TOUCH DIM

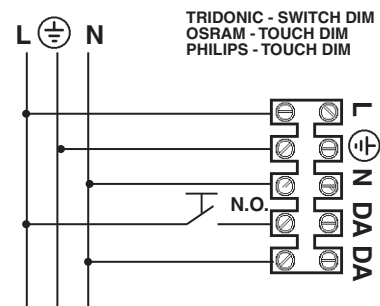

- I I dispositivi con cablaggio digitale possono essere dimmerati con dispositivi DALI o con pulsante normalmente aperto (N.O.) da collegare come da schema.
 GB Devices with digital control gear may be dimmed using DALI devices or a normally-open button (N.O.) to be connected as shown in the diagram.
 F Les articles à câblage numérique peuvent fonctionner avec des variateurs à dispositifs DALI ou à bouton poussoir normalement ouvert (N.O.) à relier conformément au schéma.
 D Die Geräte mit digitaler Verkabelung können mit Hilfe von DALI-Vorrichtungen oder mit Hilfe eines gemäß Schaltplan anzuschließenden Schließers (N.O.) gedimmt werden.
 NL De producten met digitale bekabeling kunnen worden gedimd met DALI systemen of met een N.O. (normally open) knop, die moet worden aangesloten volgens schema.
 E Los dispositivos con cableado digital pueden regularse con dispositivos DALI o con un interruptor de botón normalmente abierto (N.O.) que se conecta según ilustrado en el esquema.
 DK Produkter med digital kabelføring kan dæmpes med DALI-anordninger eller med kontakten, som normalt er åben (N.O.) og som skal tilsluttes, som vist.
 N Produkter med digitalkabler kan dimmes med DALI-anordninger eller med en normalt åpen (NO) trykkbryter som kobles som vist i koblingsskjema.
 S Produkter med digital kabeldragning kan förädas med dimmer. Detta kan göras med DALI-anordningarna eller med en normalt öppen kontakt (N.O.) som ska anslutas enligt schemat.
 RUS Интенсивность приборов с цифровой проводкой может регулироваться посредством устройств DALI или нормально разомкнутой кнопкой (Н.Р.), подсоединяемой согласно схеме.
 CN 带有数字控制装置的设备可以通过 DALI (数字化可寻址调光接口) 设备或者一个连接方式如图中所示的常开按钮 (N.O.) 进行亮度调节



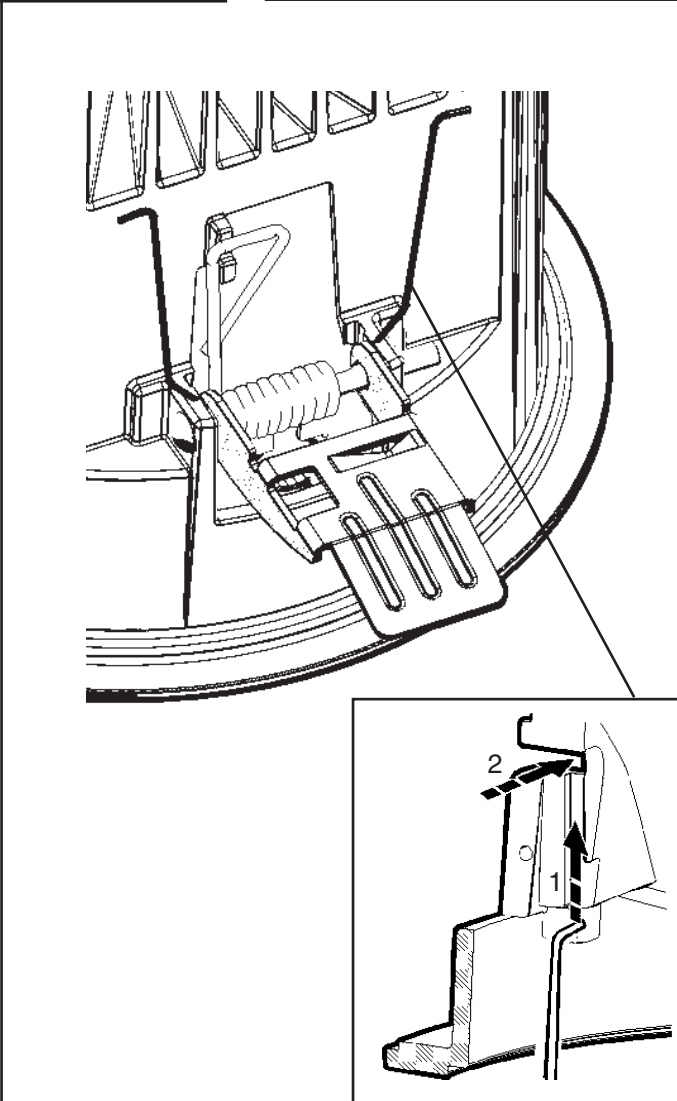

75/78

OK
 VERDE
 GREEN
 VERT
 GRÜN
 GROEN
 VERDE
 GRÖN
 GRÖNN
 GRÖN
 ЗЕЛЕНЬИЙ
 绿色

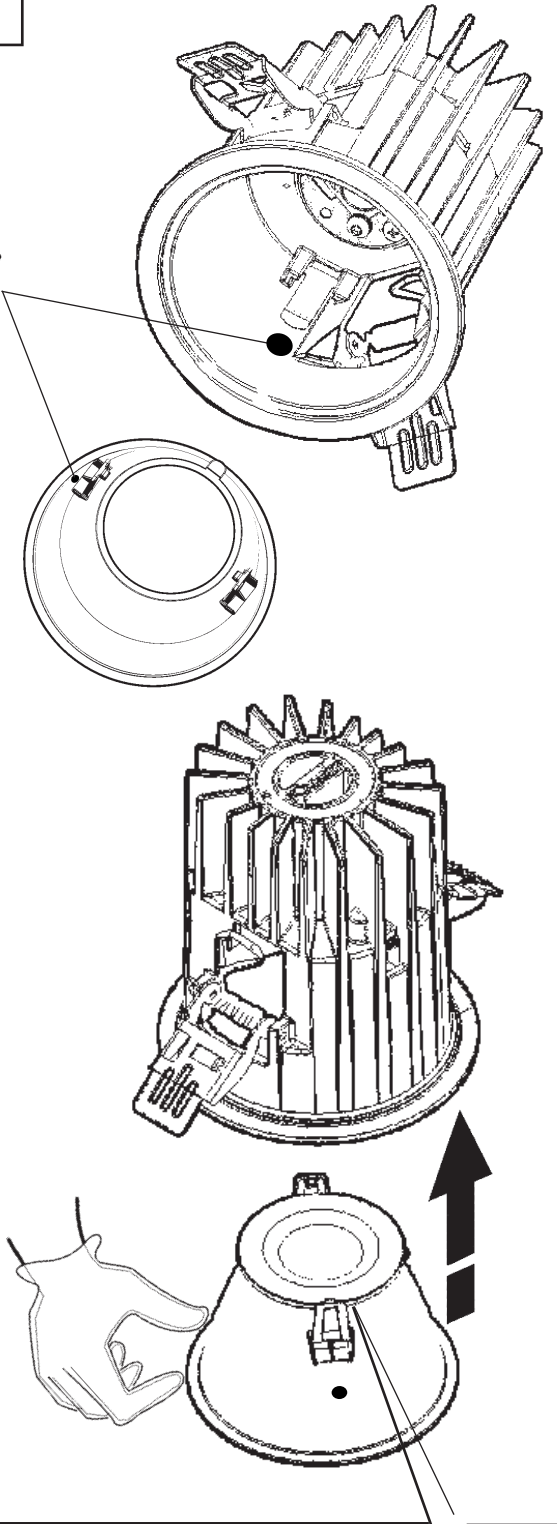

CLICK!

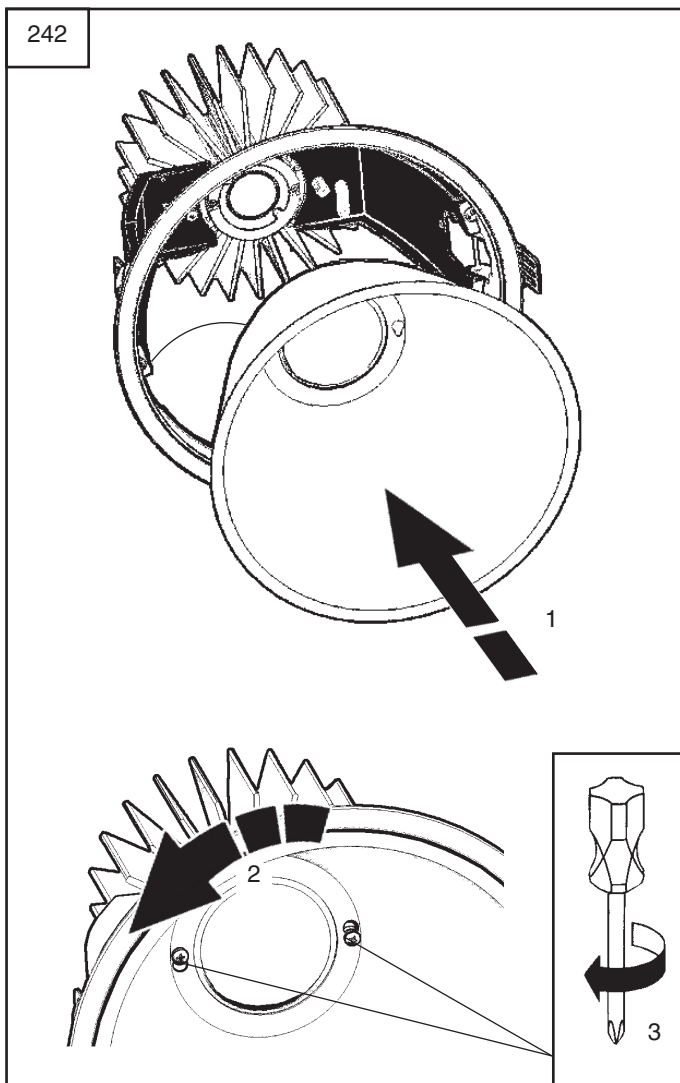

SOSTITUZIONE DEL LED
 REPLACING THE LED
 REMPLACEMENT DE LA LED
 AUSTAUSCHEN DER LED
 VERVANGEN VAN DE LED
 REEMPLAZO DEL LED
 UDSKIFTNING AF LYSDIODE
 BYTE AV LYSDIOD
 UTSKIFTNING AV DEN LYSEMITTERENDE DIODEN
 ЗАМЕНА СИДд
 发光二极管替换

I N.B.: Per la sostituzione del LED contattare l'azienda iGuzzini.
 GB N.B.: For information on LED replacement please contact iGuzzini.
 F N.B.: Pour procéder au remplacement de la LED, adressez-vous à la société iGuzzini.
 D Ñ.B.: Bezüglich des Austausches der LED kontaktieren Sie bitte die Firma iGuzzini.
 NL N.B.: Voor het vervangen van de LED neemt u contact op met het bedrijf iGuzzini.
 E NOTA: Para sustituir el LED llame a la empresa iGuzzini.
 DK N.B.: For udskiftning af lysdioden, skal man kontakte iGuzzini.
 N N.B.: For informasjon om skifte av LED, vennligst ta kontakt med iGuzzini.
 S OBS! För byte av lysdioden, kontakta företaget iGuzzini.
 RUS ПРИМЕЧАНИЕ: Для замены СИДов обращайтесь в компанию iGuzzini.
 CN 注意：如需LED更换的信息，请联系iGuzzini。

| | | |
|--|---|--|
| ART.  | CARICO DALI / DALI LOAD CHARGE DALI (COURANT MAXI ADMISSIBLE) DALI-LAST DALI VERMOGEN CARGA DALI DALI STRØMSTYRKE BELASTNING FOR "DALI" DALI-BELASTNING МАКС. ТОК СИСТЕМЫ DALI С РЕГУЛЯЦИЕЙ ИНТЕНСИВНОСТИ СВЕТА DALI 智能调光系统允许的最大电流量 | INDIRIZZI DALI DALI ADDRESSES ADRESSES DALI DALI-ADRESSEN DALI ADRESSEN DIRECCIONES DALI DALI ADRESSER ADRESSER TIL "DALI" DALI-ADRESSER ЛОГИЧЕСКИЕ АДРЕСА СИСТЕМЫ DALI DALI智能调光系统计算机指定控制参数 |
| | 1 | 1 |

THE REFLEX LED COB FISSI/WALL WASHER



MINIMAL
78/104/134/152



FRAME
75/96/125/153/212/242

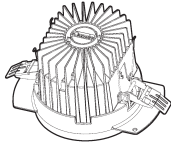

تحذير:

لا يمكن ضمان سلامة هذا الجهاز إلا إذا التزمت بهذه التعليمات. يجب حفظها في مكان آمن.

ATTENZIONE:

LA SICUREZZA DELL'APPARECCHIO E' GARANTITA SOLO CON L'USO APPROPRIATO DELLE SEGUENTI ISTRUZIONI; PERTANTO E' NECESSARIO CONSERVARLE.

GB WARNING:

THE SAFETY OF THIS FIXTURE IS GUARANTEED ONLY IF YOU COMPLY WITH THESE INSTRUCTIONS; REMEMBER TO CONSERVE IN A SAFE PLACE.

E ATENCION:

LA SEGURIDAD DEL APARATO SE GARANTIZA SOLO CUMPLIENDO CUIDADOSAMENTE LAS SIGUIENTES INSTRUCCIONES; POR ELLO, ES NECESARIO CONSERVARLAS.



ملاحظة: ملاحظة: أثناء تركيب نظام . يجب التقيد بحرص بالنظم السائدة المتعلقة بالشبكة الكهربائية.

N.B.: DURANTE L'INSTALLAZIONE DEL SISTEMA RISPETTARE SCRUPolosAMENTE LE NORME IMPIANTISTICHE NAZIONALI VIGENTI.

N.B.: WHEN INSTALLING THE SYSTEM, MAKE SURE ALL CURRENT NATIONAL REGULATIONS RELATING TO INSTALLATION ARE OBSERVED.

NOTA: DURANTE LA INSTALACIÓN DEL SISTEMA RESPETAR ESCRUPolosAMENTE LAS NORMAS NACIONALES DE INSTALACIÓN EN VIGOR.



| ∅ | الصنف ART. | X max mm | Y max mm |
|-----|---|----------|----------|
| 96 | N121-N122-N123-N124-N125-Q978 | | |
| 125 | N111 - N112 - N113 - N114 - N115 N239 - N240 - N241 - N242 - N243 N244 - N245 - N246 - N247 - N248 N126 - N127 - N128 - N129 - N130 Q979-Q980-Q981-Q982 | 850 | 900 |
| 153 | N116 - N117 - N118 - N119 - N120 N131 - N132 - N133 - N134 - N135 Q983-Q984 | 1000 | 1150 |
| 212 | MN01 - MN02 - MN03 - MN04 - N136 | 1100 | 1200 |

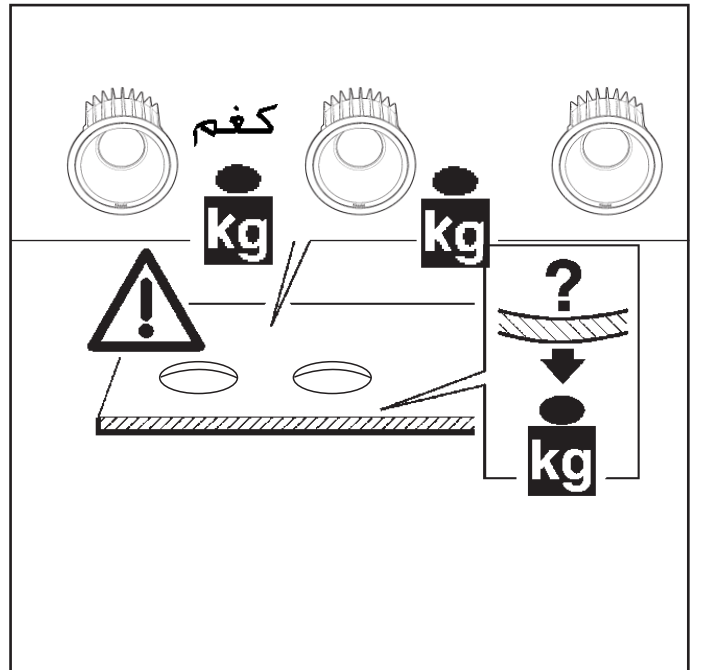
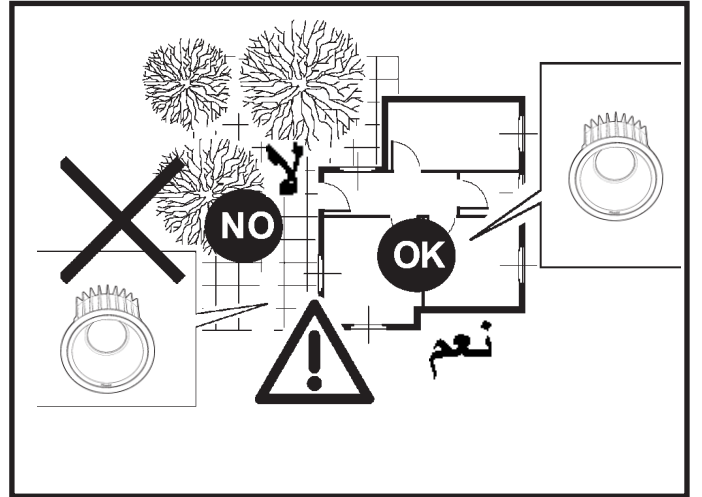



ملاحظة: أجهزة غير قابلة للتغطية مواد عازلة حرارياً.

- I N.B.: Apparecchi non idonei ad essere coperti di materiale termicamente isolante.
- GB N.B.: Fixtures not suitable to be covered in thermally-insulating material.
- E NOTA: Aparatos no aptos para ser cubiertos de material térmicamente aislante.

Art. MV78-MV79-MV80-MV81-MV82-MV83-MV84-MV85-MV86-MV87
 MV88-MV89-MV90-MV91-MV92-MV93-MV94-MV95-MV96-MV97
 MV98-MV99-N000-N001-N002-N003-N004-N005-N229-N230-N231
 N232-N233-N234-N235-N236-N237-N238-N006-N007-N008-N009
 N010-N011-N012-N013-N014-N015-N224-MM97-M225-MM98-N226
 MM99-N227-MN00-N228-N016-M636-P586-P587-P588-P589-P507-
 P508-P509-P510-P511-P512-P513-P514-P515-P516-P517-P518
 P519-P520-P521-P522-P523-P524-P525-P526-P527-P528-P529-P530
 P531-P532-P533-Q959-Q960-Q961-Q964-Q965-Q966-Q967-Q968-Q969
 Q974-Q975



Art. N017-N018-N019-N020-N021-N022-N023-N024

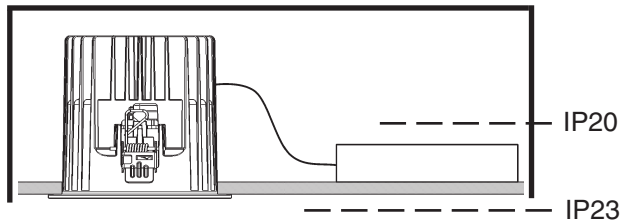

Art. MV40-MV41-MV42-MV43-MV44-MV45-MV46-MV47-MV48-MV49
 MV50-MV51-MV52-MV53-MV54-MV55-MV56-MV57-N121-N122-N123
 N124-N125-MV58-MV59-MV60-MV61-MV62-MV63-MV64-MV65-MV66
 MV67-N111-N112-N113-N114-N115 N214-N215-N216-N217-N218
 N219-N220-N221-N222-N223-N239-N240-N241-N242-N243-N244-N245
 N246-N247-N248-MV68-MV69-MV70-MV71-MV72-MV73-MV74-MV75
 MV76-MV77-N116-N117-N118-N119-N120-N131-N132-N133-N134
 N135-MN01-MN02-MN03-MN04-N136
 Q962-Q963-Q970-Q971-Q972-Q973-Q976-Q977

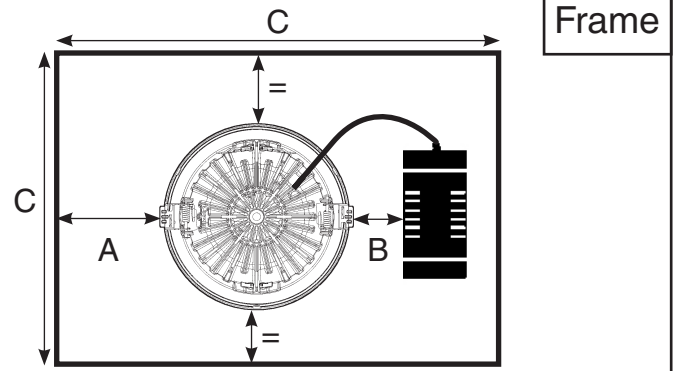

Frame

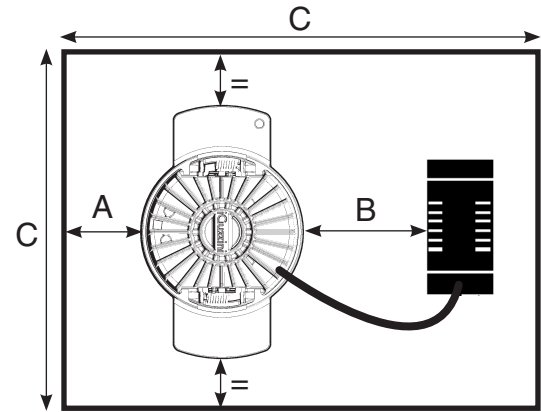

Minimal

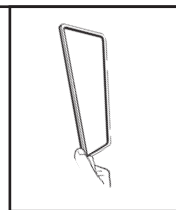
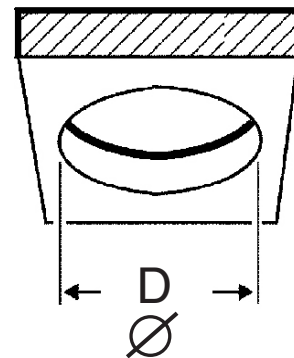

| الصنف ART. | ∅ D mm مم | S mm مم | H mm مم | A mm مم | B mm مم | C mm مم |
|---|---------------------|---------------|---------------|---------------|---------------|---------------|
| MV40-MV41-MV42-MV43 MV44-MV45-MV46-MV47 | 78 ^{±1} | 12,5 | 100 | | 100 | 350 |
| MV78-MV79-MV80-MV81-P586-P587 MV82-MV83-MV84-MV85-P588-P589 | 75 ⁺²⁻⁰ | 1±20 | 100 | | 100 | 350 |
| MV48-MV49-MV50-MV51- MV52 MV53-MV54-MV55-MV56-MV57 Q962-Q963 | 104 ^{±1} | 12,5 | 100 | | 100 | 350 |
| MV86-MV87-MV88-MV89-MV90-P507 MV91-MV92-MV93-MV94-MV95-P508 N121-N122-N123-N124-N125-P509-P510 Q959-Q960-Q961-Q978 | 96 ⁺²⁻⁰ | 1±20 | 100 | | 100 | 350 |
| MV58-MV59-MV60-MV61-MV62 MV63-MV64-MV65-MV66-MV67 N111-N112-N113-N114-N115-N214 N215-N216-N21-N218-N219-N220 N221-N222-N223-N239-N240 N241-N242-N243 Q970-Q971-Q972-Q973-Q981-Q982 | 134 ^{±1} | 12,5 | 111 | | 100 | 350 |
| MV96-MV97-MV98-MV99-N000-P511 N001-N002-N003-N004-N005-N126 N127-N128-N129-N130-N229-N230 N231-N232-N233-N234-N235-N236 N237-N238-N244-N245-P512-P513 N246-N247-N248-P514-P515-P516 P517-P518 - P523 - P524 - P525 P526-P527-P528-Q964-Q965-Q966-Q967 Q968-Q969-Q979-Q980 | 125 ⁺²⁻⁰ | 1±20 | 109 | 50 | 100 | 350 |
| MV68-MV69-MV70-MV71-MV72 MV73-MV74-MV75-MV76-MV77 N116-N117-N118-N119-N120 Q976-Q977-Q984 | 152 ^{±1} | 12,5 | 125 | | 100 | 500 |
| N006-N007-N008-N009-N010-N011 N012-N013-N014-N015-N131-N132 N133-N134-N135 Q974-Q975-Q983 | 153 ⁺²⁻⁰ | 1±25 | 123 | | 100 | 500 |
| N224-N225-N226-N227-P519-P520 MM97-MM98-MM99-MN00-P521 MN01-MN02-MN03-MN04-P522 | 212 ⁺²⁻⁰ | 1±25 | 150 | | 150 | 600 |
| N228-N016 - M636-N136-P529 P530-P531-P532-P533 | | | 190 | | | |
| N017-N018-N019-N020 N021-N022-N023-N024 | 242 ⁺²⁻⁰ | 1±25 | 250 | | 150 | 600 |



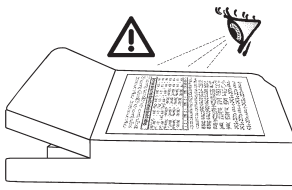

| | S mm ² ملم ² | Y mm ملم | X mm ملم | D mm ملم |
|---------------------------|---------------------------------------|-------------|-------------|-------------|
| * TCI DC MAXI JOLLY | 0,5 - 2,5 | 6 ± 0,5 | | 3 - 8 |
| OSRAM OT Fit | | 9 ± 0,5 | ~ 30 | / |
| OSRAM OT i DALI | 0,5 - 1,5 | 8 - 9 | | 7 - 11 |
| PHILIPS Xitanium LH | | 9 ± 0,5 | ~ 25 | / |
| PHILIPS Xitanium / m | 0,2 - 1,5 | 8,5 - 9,5 | | / |
| PHILIPS SH | 0,75 - 2,5 | 10 - 11 | ~ 40 | / |
| TRIDONIC LCAI - LCI | 0,5 - 2,5 | | ~ 30 | 10 - 11 |
| TRIDONIC LC | | 8,5 - 9,5 | ~ 40 | / |
| OSRAM OTe 35 | 0,5 - 1,5 | 8 - 9 | ~ 30 | / |

للتوصيل بالكهرباء قم بالرجوع إلى العلامة المتواجدة على وحدة التغذية.

I Per il collegamento elettrico fare riferimento alla marcatura dell'alimentatore.

GB Refer to the marking on the power unit for the electrical connection.

E Para la conexión eléctrica hacer referencia a las informaciones marcadas en el alimentador.

يمكن أن يتسبب التحكم في منتجات "دالي" المختلفة عن طريق الأزرار ، (مثل الأزرار : "تنش - ديم"، "سويتش - ديم"، "بوش - ديم"، "دايركت - ديم"، "البح" ، في حدوث مشاكل تتعلق بعملية التزامن بين هذه الأزرار. وإن كان من الممكن تجنب مثل هذه المشاكل، وذلك عن طريق تزويد بعض الأجهزة الإضافية. ندعوكم للاتصال المباشر بالشركة، وذلك للحصول على أكبر قدر من المعلومات.

I Pilotare diversi prodotti DALI tramite pulsante (es: Touch-dim, Switch-dim, Push-dim, Direct-dim, etc.) potrebbe causare dei problemi di sincronizzazione tra gli stessi. È possibile ovviare a questo problema dotandosi di dispositivi aggiuntivi. Per maggiori informazioni vi invitiamo a contattarci direttamente.

GB Controlling different DALI products through buttons (e.g.: Touch-dim, Switch-dim, Push-dim, Direct-dim, etc.) may lead to product synchronisation problems. This problem can be overcome by using additional devices. For further information, please contact us directly.

E El mando de varios productos DALI por tecla (ej: Touch-dim, Switch-dim, Push-dim, Direct-dim, etc.) podría causar problemas de sincronización entre ellos. Es posible prevenir este problema utilizando dispositivos adicionales. Para más información, contacte directamente con nosotros.

DALI

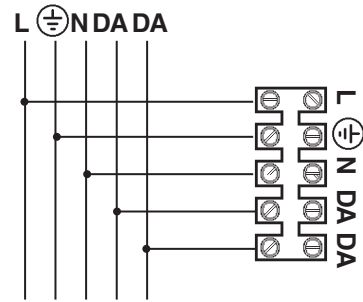

يمكن أن يتم تخفيض إضاءة الأجهزة ذات الكابلات الرقمية؛ وذلك عن طريق استخدام أجهزة الإمداد بالطاقة الكهربائية "دالي" (DALI)، أو عن طريق استخدام زر يكون مفتوحًا في وضعه الطبيعي (N.O)؛ حيث يتم التوصيل كما هو مبين في المخطط.

I I dispositivi con cablaggio digitale possono essere dimmerati con dispositivi DALI o con pulsante normalmente aperto (N.O.) da collegare come da schema.

GB Devices with digital control gear may be dimmed using DALI devices or a normally-open button (N.O.) to be connected as shown in the diagram.

E Los dispositivos con cableado digital pueden regularse con dispositivos DALI o con un interruptor de botón normalmente abierto (N.O.) que se conecta según ilustrado en el esquema.

SWITCH DIM / TOUCH DIM







75/78

OK
 نعم
 أخضر
 VERDE
 GREEN
 VERDE



طقة
 CLICK!

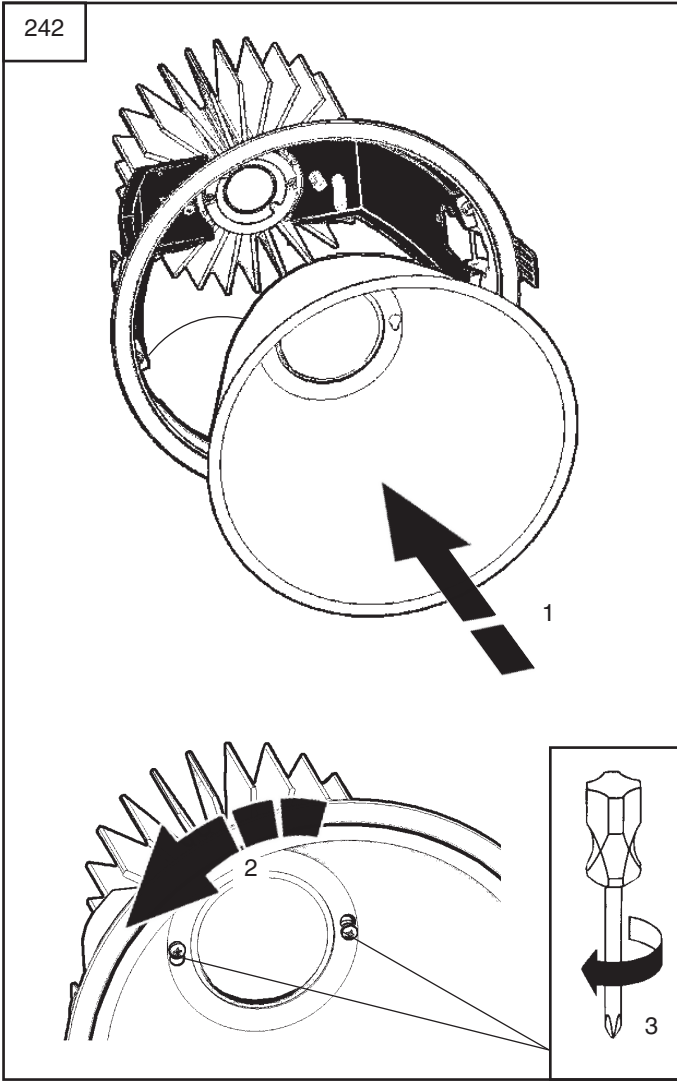

استبدال الضوء LED

SOSTITUZIONE DEL LED
REPLACING THE LED
REEMPLAZO DEL LED

تنبيه: لاستبدال الضوء LED اتصل بشركة iGuzzini.

I N.B.: Per la sostituzione del LED contattare l'azienda iGuzzini.
GB N.B.: For information on LED replacement please contact iGuzzini.
E NOTA: Para sustituir el LED llame a la empresa iGuzzini.

| الصفحة | DALI شحنة / DALI حمل | DALI عناوين |
|---|--|--|
| ART. | CARICO DALI / DALI LOAD CHARGE DALI CARGA DALI | INDIRIZZI DALI DALI ADDRESSES DIRECCIONES DALI |
|  | 1 | 1 |

| 1.154.119.05 IS09154/07 | iQuzini | fattore di potenza power factor facteur de puissance Leistungsfaktor vermogensfactor factor de potencia effektfaktor effektfaktor effektfaktor фактор мощности 功率因数 | corrente assorbita absorbed current courant absorbé Stromaufnahme stroomopname corriente absorbida absorberet strøm absorbert strøm tillförd ström поглощаемая мощность 电源电流 |
|---|----------------|---|--|
| ART. | λ | A | A |
| MV40-MV41-MV78-MV79 -P586 | >0,9 | 0,042 | |
| MV42-MV43-MV80-MV81-P587 | 0,9 | 0,044 | |
| MV44-MV45-MV82-MV83-P588 | >0,9 | 0,048 | |
| MV46-MV47-MV84-MV85-P589 | >0,9 | 0,050 | |
| MV48-MV49-MV86-MV87-N121 -P507 | >0,95 | 0,051 | |
| MV50-MV51-MV88-MV89-N122 -P508 | >0,95 | 0,053 | |
| MV52-MV53-MV90-MV91-N123 -P509 | >0,9 | 0,054 | |
| MV54-MV55-MV92-MV93-N124 | >0,9 | 0,056 | |
| MV56-MV57-MV94-MV95-N125 -P510 Q959 - Q960 - Q962 - Q963 - Q978 - Q961 | >0,9 | 0,064 | |
| MV58-MV59-MV96-MV97-N111-N126 -P511 | >0,95 | 0,068 | |
| "N214-N215- N229-N230-N239-N244 -P512 MV68-MV69-N006-N007-N116-N131 | >0,9 | 0,112 | |
| MV60-MV61-MV98-MV99-N112-N127 -P513 | >0,95 | 0,069 | |
| "N216-N217-N231-N232-N240-N245 -P514 MV70-MV71-N008-N009-N117-N132 | >0,9 | 0,112 | |
| MV62-MV63-N000-N001-N113-N128 -P515 | >0,95 | 0,068 | |
| "N218-N219-N233-N234-N241-N246 -P516 MV72-MV73-N010-N011-N118-N133 | >0,95 | 0,107 | |
| MV64-MV65-N002-N003-N114-N129 | >0,95 | 0,069 | |
| "N220-N221-N235-N236-N242-N247 MV74-MV75-N012-N013-N119-N134 | >0,95 | 0,112 | |
| MV66-MV67-N004-N005-N115-N130 -P517 Q966 - Q968 - Q970 - Q972 - Q979 - Q981 - Q964 | >0,95 | 0,086 | |
| N222-N223-N237-N238-N243-N248 -P518 Q967 - Q969 - Q971 - Q973 - Q980 - Q982 - Q965 | >0,95 | 0,14 | |
| MV76-MV77-N014-N015-N120-N135 Q974 - Q975 - Q976 - Q977 - Q983 - Q984 | >0,95 | 0,134 | |
| N224-MM97-MN01-P519 | >0,95 | 0,161 | |
| N225-MM98-MN02 -P520 | >0,95 | 0,165 | |
| N226-MM99-MN03 -P521 | >0,95 | 0,159 | |
| N227-MN00-MN04 | >0,95 | 0,165 | |
| N228-N016-N136 -P522 | >0,95 | 0,203 | |
| N017-N018 | >0,95 | 0,252 | |
| N019-N020 | >0,95 | 0,264 | |
| N021-N022 | >0,95 | 0,252 | |
| N023-N024 | >0,95 | 0,264 | |
| P523 - P524 - P525 | >0,95 | 0,109 | |
| P526- P527- P528 | >0,95 | 0,134 | |
| P529 - P530 -P531 | >0,95 | 0,193 | |
| M636 - P532 - P533 | >0,95 | 0,263 | |
| Q262 | >0,9 | 0,096 | |
| Q263 | >0,9 | 0,158 | |
| Q264 | >0,9 | 0,13 | |

| 1.154.119.05 IS09154/07 | iQuzini | fattore di potenza power factor facteur de puissance Leistungsfaktor vermogensfactor factor de potencia effektfaktor effektfaktor effektfaktor фактор мощности 功率因数 | corrente assorbita absorbed current courant absorbé Stromaufnahme stroomopname corriente absorbida absorberet strøm absorbert strøm tillförd ström поглощаемая мощность 电源电流 |
|---|----------------|---|--|
| ART. | λ | A | A |
| MV40-MV41-MV78-MV79 -P586 | >0,9 | 0,042 | |
| MV42-MV43-MV80-MV81-P587 | 0,9 | 0,044 | |
| MV44-MV45-MV82-MV83-P588 | >0,9 | 0,048 | |
| MV46-MV47-MV84-MV85-P589 | >0,9 | 0,050 | |
| MV48-MV49-MV86-MV87-N121 -P507 | >0,95 | 0,051 | |
| MV50-MV51-MV88-MV89-N122 -P508 | >0,95 | 0,053 | |
| MV52-MV53-MV90-MV91-N123 -P509 | >0,9 | 0,054 | |
| MV54-MV55-MV92-MV93-N124 | >0,9 | 0,056 | |
| MV56-MV57-MV94-MV95-N125 -P510 Q959 - Q960 - Q962 - Q963 - Q978 - Q961 | >0,9 | 0,064 | |
| MV58-MV59-MV96-MV97-N111-N126 -P511 | >0,95 | 0,068 | |
| "N214-N215- N229-N230-N239-N244 -P512 MV68-MV69-N006-N007-N116-N131 | >0,9 | 0,112 | |
| MV60-MV61-MV98-MV99-N112-N127 -P513 | >0,95 | 0,069 | |
| "N216-N217-N231-N232-N240-N245 -P514 MV70-MV71-N008-N009-N117-N132 | >0,9 | 0,112 | |
| MV62-MV63-N000-N001-N113-N128 -P515 | >0,95 | 0,068 | |
| "N218-N219-N233-N234-N241-N246 -P516 MV72-MV73-N010-N011-N118-N133 | >0,95 | 0,107 | |
| MV64-MV65-N002-N003-N114-N129 | >0,95 | 0,069 | |
| "N220-N221-N235-N236-N242-N247 MV74-MV75-N012-N013-N119-N134 | >0,95 | 0,112 | |
| MV66-MV67-N004-N005-N115-N130 -P517 Q966 - Q968 - Q970 - Q972 - Q979 - Q981 - Q964 | >0,95 | 0,086 | |
| N222-N223-N237-N238-N243-N248 -P518 Q967 - Q969 - Q971 - Q973 - Q980 - Q982 - Q965 | >0,95 | 0,14 | |
| MV76-MV77-N014-N015-N120-N135 Q974 - Q975 - Q976 - Q977 - Q983 - Q984 | >0,95 | 0,134 | |
| N224-MM97-MN01-P519 | >0,95 | 0,161 | |
| N225-MM98-MN02 -P520 | >0,95 | 0,165 | |
| N226-MM99-MN03 -P521 | >0,95 | 0,159 | |
| N227-MN00-MN04 | >0,95 | 0,165 | |
| N228-N016-N136 -P522 | >0,95 | 0,203 | |
| N017-N018 | >0,95 | 0,252 | |
| N019-N020 | >0,95 | 0,264 | |
| N021-N022 | >0,95 | 0,252 | |
| N023-N024 | >0,95 | 0,264 | |
| P523 - P524 - P525 | >0,95 | 0,109 | |
| P526- P527- P528 | >0,95 | 0,134 | |
| P529 - P530 -P531 | >0,95 | 0,193 | |
| M636 - P532 - P533 | >0,95 | 0,263 | |
| Q262 | >0,9 | 0,096 | |
| Q263 | >0,9 | 0,158 | |
| Q264 | >0,9 | 0,13 | |

| 1.154.119.05 IS09154/07 | iQuzini | fattore di potenza power factor facteur de puissance Leistungsfaktor vermogensfactor factor de potencia effektfaktor effektfaktor effektfaktor фактор мощности 功率因数 | corrente assorbita absorbed current courant absorbé Stromaufnahme stroomopname corriente absorbida absorberet strøm absorbert strøm tillförd ström поглощаемая мощность 电源电流 |
|---|----------------|---|--|
| ART. | λ | A | A |
| MV40-MV41-MV78-MV79 -P586 | >0,9 | 0,042 | |
| MV42-MV43-MV80-MV81-P587 | 0,9 | 0,044 | |
| MV44-MV45-MV82-MV83-P588 | >0,9 | 0,048 | |
| MV46-MV47-MV84-MV85-P589 | >0,9 | 0,050 | |
| MV48-MV49-MV86-MV87-N121 -P507 | >0,95 | 0,051 | |
| MV50-MV51-MV88-MV89-N122 -P508 | >0,95 | 0,053 | |
| MV52-MV53-MV90-MV91-N123 -P509 | >0,9 | 0,054 | |
| MV54-MV55-MV92-MV93-N124 | >0,9 | 0,056 | |
| MV56-MV57-MV94-MV95-N125 -P510 Q959 - Q960 - Q962 - Q963 - Q978 - Q961 | >0,9 | 0,064 | |
| MV58-MV59-MV96-MV97-N111-N126 -P511 | >0,95 | 0,068 | |
| "N214-N215- N229-N230-N239-N244 -P512 MV68-MV69-N006-N007-N116-N131 | >0,9 | 0,112 | |
| MV60-MV61-MV98-MV99-N112-N127 -P513 | >0,95 | 0,069 | |
| "N216-N217-N231-N232-N240-N245 -P514 MV70-MV71-N008-N009-N117-N132 | >0,9 | 0,112 | |
| MV62-MV63-N000-N001-N113-N128 -P515 | >0,95 | 0,068 | |
| "N218-N219-N233-N234-N241-N246 -P516 MV72-MV73-N010-N011-N118-N133 | >0,95 | 0,107 | |
| MV64-MV65-N002-N003-N114-N129 | >0,95 | 0,069 | |
| "N220-N221-N235-N236-N242-N247 MV74-MV75-N012-N013-N119-N134 | >0,95 | 0,112 | |
| MV66-MV67-N004-N005-N115-N130 -P517 Q966 - Q968 - Q970 - Q972 - Q979 - Q981 - Q964 | >0,95 | 0,086 | |
| N222-N223-N237-N238-N243-N248 -P518 Q967 - Q969 - Q971 - Q973 - Q980 - Q982 - Q965 | >0,95 | 0,14 | |
| MV76-MV77-N014-N015-N120-N135 Q974 - Q975 - Q976 - Q977 - Q983 - Q984 | >0,95 | 0,134 | |
| N224-MM97-MN01-P519 | >0,95 | 0,161 | |
| N225-MM98-MN02 -P520 | >0,95 | 0,165 | |
| N226-MM99-MN03 -P521 | >0,95 | 0,159 | |
| N227-MN00-MN04 | >0,95 | 0,165 | |
| N228-N016-N136 -P522 | >0,95 | 0,203 | |
| N017-N018 | >0,95 | 0,252 | |
| N019-N020 | >0,95 | 0,264 | |
| N021-N022 | >0,95 | 0,252 | |
| N023-N024 | >0,95 | 0,264 | |
| P523 - P524 - P525 | >0,95 | 0,109 | |
| P526- P527- P528 | >0,95 | 0,134 | |
| P529 - P530 -P531 | >0,95 | 0,193 | |
| M636 - P532 - P533 | >0,95 | 0,263 | |
| Q262 | >0,9 | 0,096 | |
| Q263 | >0,9 | 0,158 | |
| Q264 | >0,9 | 0,13 | |

1.154.544.00

IS00766/05

SOSTITUZIONE DEL LED
REPLACING THE LED
REPLACEMENT DE LA LED
AUSTAUSCHEN DER LED
VERVANGEN VAN DE LED
REEMPLAZO DEL LED
UDSKIFTNING AF LYSDIODE
BYTE AV LYSDIOD
UTSKIFTING AV DEN LYSEMITTERENDE DIODEN
ЗАМЕНА СИДа
发光二极管替换

I N.B.: Per la sostituzione del LED contattare l'azienda iGuzzini.

GB N.B.: For information on LED replacement please contact iGuzzini.

F N.B.: Pour procéder au remplacement de la LED, adressez-vous à la société iGuzzini.

D N.B.: Bezüglich des Austausches der LED kontaktieren Sie bitte die Firma iGuzzini.

NL N.B.: Voor het vervangen van de LED neemt u contact op met het bedrijf iGuzzini.

E NOTA: Para sustituir el LED llame a la empresa iGuzzini.

DK N.B.: For udskiftning af lysdioden, skal man kontakte iGuzzini.

N N.B.: For informasjon om skifte av LED, vennligst ta kontakt med iGuzzini.

S OBS! För byte av lysdioden, kontakta företaget iGuzzini.

RUS ПРИМЕЧАНИЕ:Для замены СИДов обращайтесь в компанию iGuzzini.

CN 注意: 如需LED更换的信息, 请联系iGuzzini.

I Gruppo di rischio 1, secondo norma **EN 62471: 2008**
GB Risk Group: 1, in compliance with Standard **EN 62471: 2008**
FR Groupe de risque 1, suivant la norme **EN 62471 : 2008**
DE Risikogruppe 1, gemäß Vorschrift **EN 62471: 2008**
NL Risicogroep 1, volgens de norm **EN 62471: 2008**
E Grupo de riesgo 1, según norma **EN 62471: 2008**
DK Faregruppe 1 i henhold til standarden **EN 62471: 2008**
N Risikogruppe 1, i henhold til forskriften **EN 62471: 2008**
S Riskgrupp 1, enligt standard **EN 62471: 2008**
RUS ГРУПП РИСК 1 В СООТВЕТСТВИИ СО **EN 62471: 2008**

CN 风险组:1
灯具和灯具系统的光生物学安全性符合标准 **EN 62471: 2008**

iGuzzini

1.154.544.00

IS00766/05

SOSTITUZIONE DEL LED
REPLACING THE LED
REPLACEMENT DE LA LED
AUSTAUSCHEN DER LED
VERVANGEN VAN DE LED
REEMPLAZO DEL LED
UDSKIFTNING AF LYSDIODE
BYTE AV LYSDIOD
UTSKIFTING AV DEN LYSEMITTERENDE DIODEN
ЗАМЕНА СИДа
发光二极管替换

I N.B.: Per la sostituzione del LED contattare l'azienda iGuzzini.

GB N.B.: For information on LED replacement please contact iGuzzini.

F N.B.: Pour procéder au remplacement de la LED, adressez-vous à la société iGuzzini.

D N.B.: Bezüglich des Austausches der LED kontaktieren Sie bitte die Firma iGuzzini.

NL N.B.: Voor het vervangen van de LED neemt u contact op met het bedrijf iGuzzini.

E NOTA: Para sustituir el LED llame a la empresa iGuzzini.

DK N.B.: For udskiftning af lysdioden, skal man kontakte iGuzzini.

N N.B.: For informasjon om skifte av LED, vennligst ta kontakt med iGuzzini.

S OBS! För byte av lysdioden, kontakta företaget iGuzzini.

RUS ПРИМЕЧАНИЕ:Для замены СИДов обращайтесь в компанию iGuzzini.

CN 注意: 如需LED更换的信息, 请联系iGuzzini.

I Gruppo di rischio 1, secondo norma **EN 62471: 2008**
GB Risk Group: 1, in compliance with Standard **EN 62471: 2008**
FR Groupe de risque 1, suivant la norme **EN 62471 : 2008**
DE Risikogruppe 1, gemäß Vorschrift **EN 62471: 2008**
NL Risicogroep 1, volgens de norm **EN 62471: 2008**
E Grupo de riesgo 1, según norma **EN 62471: 2008**
DK Faregruppe 1 i henhold til standarden **EN 62471: 2008**
N Risikogruppe 1, i henhold til forskriften **EN 62471: 2008**
S Riskgrupp 1, enligt standard **EN 62471: 2008**
RUS ГРУПП РИСК 1 В СООТВЕТСТВИИ СО **EN 62471: 2008**

CN 风险组:1
灯具和灯具系统的光生物学安全性符合标准 **EN 62471: 2008**

iGuzzini

1.154.544.00

IS00766/05

SOSTITUZIONE DEL LED
REPLACING THE LED
REPLACEMENT DE LA LED
AUSTAUSCHEN DER LED
VERVANGEN VAN DE LED
REEMPLAZO DEL LED
UDSKIFTNING AF LYSDIODE
BYTE AV LYSDIOD
UTSKIFTING AV DEN LYSEMITTERENDE DIODEN
ЗАМЕНА СИДа
发光二极管替换

I N.B.: Per la sostituzione del LED contattare l'azienda iGuzzini.

GB N.B.: For information on LED replacement please contact iGuzzini.

F N.B.: Pour procéder au remplacement de la LED, adressez-vous à la société iGuzzini.

D N.B.: Bezüglich des Austausches der LED kontaktieren Sie bitte die Firma iGuzzini.

NL N.B.: Voor het vervangen van de LED neemt u contact op met het bedrijf iGuzzini.

E NOTA: Para sustituir el LED llame a la empresa iGuzzini.

DK N.B.: For udskiftning af lysdioden, skal man kontakte iGuzzini.

N N.B.: For informasjon om skifte av LED, vennligst ta kontakt med iGuzzini.

S OBS! För byte av lysdioden, kontakta företaget iGuzzini.

RUS ПРИМЕЧАНИЕ:Для замены СИДов обращайтесь в компанию iGuzzini.

CN 注意: 如需LED更换的信息, 请联系iGuzzini.

I Gruppo di rischio 1, secondo norma **EN 62471: 2008**
GB Risk Group: 1, in compliance with Standard **EN 62471: 2008**
FR Groupe de risque 1, suivant la norme **EN 62471 : 2008**
DE Risikogruppe 1, gemäß Vorschrift **EN 62471: 2008**
NL Risicogroep 1, volgens de norm **EN 62471: 2008**
E Grupo de riesgo 1, según norma **EN 62471: 2008**
DK Faregruppe 1 i henhold til standarden **EN 62471: 2008**
N Risikogruppe 1, i henhold til forskriften **EN 62471: 2008**
S Riskgrupp 1, enligt standard **EN 62471: 2008**
RUS ГРУПП РИСК 1 В СООТВЕТСТВИИ СО **EN 62471: 2008**

CN 风险组:1
灯具和灯具系统的光生物学安全性符合标准 **EN 62471: 2008**

iGuzzini

ONLY FOR DALI PRODUCT

1.154.599.01
IS03599/03

iGuzzini

- I** **ATTENZIONE:** con questo errore di collegamento il prodotto rischia di bloccarsi (FIG. 1).
Per ripristinare, premere il pulsante 5 volte in 3 secondi come in FIG. 2, dopo che il difetto è stato rimosso.
- GB** **WARNING:** with this connection error the product risks to get blocked (FIG. 1).
To restore, press the button 5 times in 3 seconds as shown in FIG. 2 after removing the defect.
- F** **ATTENTION :** cette erreur de raccordement risque de bloquer le produit (FIG. 1).
Pour rétablir son fonctionnement, appuyer sur le bouton 5 fois de suite pendant 3 secondes comme illustré FIG. 2, après avoir supprimé le défaut.
- D** **ACHTUNG:** Bei diesem Anschlussfehler kann sich das Produkt blockieren (ABB. 1).
Zum Zurücksetzen drücken Sie die Taste 5 Mal innerhalb von 3 Sekunden wie in ABB. 2 gezeigt, nachdem der Fehler behoben wurde.
- NL** **OPGELET:** met deze aansluitingsstoring riskeert u dat het product blokkeert. (AFB. 1).
Om dit te herstellen moet u 5 keer in 3 seconden op de toets drukken, zoals aangegeven in AFB. 2, nadat de storing is opgelost.
- E** **ATENCIÓN:** con este error de conexión existe un riesgo de bloqueo del producto (FIG. 1).
Para restablecer, oprimir el pulsador 5 veces en 3 segundos según ilustrado en la FIG. 2, después de eliminar el defecto.
- N** **ADVASEL:** med denne koblingsfeilen risikerer produktet å blokkeres (FIG. 1).
For å gjenopprette, trykk på knappen 5 ganger i løpet av 3 sekunder, som angitt i FIG. 2, etter at feilen er fjernet.
PAS PÅ: Ved den type feil i forbindelsen kan man risikere, at produktet låses fast (FIG. 1).
- DK** For at genoprette funktionen skal man trykke knappen ind 5 gange i 3 sekunder, som vist i FIG. 2, efter at fejlen er blevet udbedret.
- S** **OBSERVERA!** Med detta fel finns det risk för att produkten blockeras (FIG. 1).
För att återställa efter att defekten har åtgärdats, tryck ned knappen 5 gånger i 3 sekunder som i FIG. 2.
- RUS** **ВНИМАНИЕ:** при наличии этой ошибки соединения продукт может заблокироваться (PVC. 1).
Для восстановления нажмите на кнопку 5 раз за 3 секунды, как указано на PVC. 2, после того как был устранен дефект.
- CN** 注意：出现这种故障时，灯具可能停止运行（1号图表）。
要重新启动，排除故障之后，请按照2号图表按按钮五次，每次三秒钟。

FIG. 1
FIG. 1
FIG. 1
ABB. 1
AFB. 1
FIG. 1
FIG. 1
FIG. 1
FIG. 1
1号图表

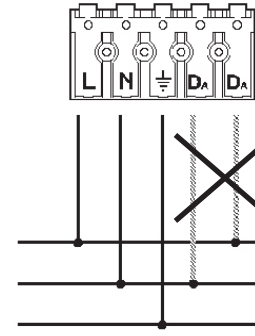

NO
NO
NON
NEIN
NEE
NO
NEI
NEJ
NEJ
HET
禁止

FIG. 2
FIG. 2
ABB. 2
AFB. 2
FIG. 2
FIG. 2
FIG. 2
2号图表



L
N
PE
禁止

ONLY FOR DALI PRODUCT

1.154.599.01
IS03599/03

iGuzzini

- I** **ATTENZIONE:** con questo errore di collegamento il prodotto rischia di bloccarsi (FIG. 1).
Per ripristinare, premere il pulsante 5 volte in 3 secondi come in FIG. 2, dopo che il difetto è stato rimosso.
- GB** **WARNING:** with this connection error the product risks to get blocked (FIG. 1).
To restore, press the button 5 times in 3 seconds as shown in FIG. 2 after removing the defect.
- F** **ATTENTION :** cette erreur de raccordement risque de bloquer le produit (FIG. 1).
Pour rétablir son fonctionnement, appuyer sur le bouton 5 fois de suite pendant 3 secondes comme illustré FIG. 2, après avoir supprimé le défaut.
- D** **ACHTUNG:** Bei diesem Anschlussfehler kann sich das Produkt blockieren (ABB. 1).
Zum Zurücksetzen drücken Sie die Taste 5 Mal innerhalb von 3 Sekunden wie in ABB. 2 gezeigt, nachdem der Fehler behoben wurde.
- NL** **OPGELET:** met deze aansluitingsstoring riskeert u dat het product blokkeert. (AFB. 1).
Om dit te herstellen moet u 5 keer in 3 seconden op de toets drukken, zoals aangegeven in AFB. 2, nadat de storing is opgelost.
- E** **ATENCIÓN:** con este error de conexión existe un riesgo de bloqueo del producto (FIG. 1).
Para restablecer, oprimir el pulsador 5 veces en 3 segundos según ilustrado en la FIG. 2, después de eliminar el defecto.
- N** **ADVASEL:** med denne koblingsfeilen risikerer produktet å blokkeres (FIG. 1).
For å gjenopprette, trykk på knappen 5 ganger i løpet av 3 sekunder, som angitt i FIG. 2, etter at feilen er fjernet.
PAS PÅ: Ved den type feil i forbindelsen kan man risikere, at produktet låses fast (FIG. 1).
- DK** For at genoprette funktionen skal man trykke knappen ind 5 gange i 3 sekunder, som vist i FIG. 2, efter at fejlen er blevet udbedret.
- S** **OBSERVERA!** Med detta fel finns det risk för att produkten blockeras (FIG. 1).
För att återställa efter att defekten har åtgärdats, tryck ned knappen 5 gånger i 3 sekunder som i FIG. 2.
- RUS** **ВНИМАНИЕ:** при наличии этой ошибки соединения продукт может заблокироваться (PVC. 1).
Для восстановления нажмите на кнопку 5 раз за 3 секунды, как указано на PVC. 2, после того как был устранен дефект.
- CN** 注意：出现这种故障时，灯具可能停止运行（1号图表）。
要重新启动，排除故障之后，请按照2号图表按按钮五次，每次三秒钟。

FIG. 1
FIG. 1
FIG. 1
ABB. 1
AFB. 1
FIG. 1
FIG. 1
FIG. 1
FIG. 1
1号图表

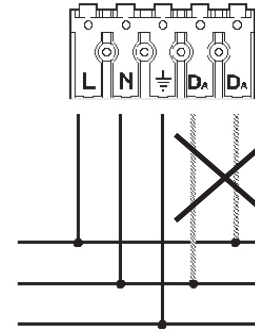

NO
NO
NON
NEIN
NEE
NO
NEI
NEJ
NEJ
HET
禁止

FIG. 2
FIG. 2
ABB. 2
AFB. 2
FIG. 2
FIG. 2
FIG. 2
2号图表



L
N
PE
禁止

ONLY FOR DALI PRODUCT

1.154.599.01
IS03599/03

iGuzzini

- I** **ATTENZIONE:** con questo errore di collegamento il prodotto rischia di bloccarsi (FIG. 1).
Per ripristinare, premere il pulsante 5 volte in 3 secondi come in FIG. 2, dopo che il difetto è stato rimosso.
- GB** **WARNING:** with this connection error the product risks to get blocked (FIG. 1).
To restore, press the button 5 times in 3 seconds as shown in FIG. 2 after removing the defect.
- F** **ATTENTION :** cette erreur de raccordement risque de bloquer le produit (FIG. 1).
Pour rétablir son fonctionnement, appuyer sur le bouton 5 fois de suite pendant 3 secondes comme illustré FIG. 2, après avoir supprimé le défaut.
- D** **ACHTUNG:** Bei diesem Anschlussfehler kann sich das Produkt blockieren (ABB. 1).
Zum Zurücksetzen drücken Sie die Taste 5 Mal innerhalb von 3 Sekunden wie in ABB. 2 gezeigt, nachdem der Fehler behoben wurde.
- NL** **OPGELET:** met deze aansluitingsstoring riskeert u dat het product blokkeert. (AFB. 1).
Om dit te herstellen moet u 5 keer in 3 seconden op de toets drukken, zoals aangegeven in AFB. 2, nadat de storing is opgelost.
- E** **ATENCIÓN:** con este error de conexión existe un riesgo de bloqueo del producto (FIG. 1).
Para restablecer, oprimir el pulsador 5 veces en 3 segundos según ilustrado en la FIG. 2, después de eliminar el defecto.
- N** **ADVASEL:** med denne koblingsfeilen risikerer produktet å blokkeres (FIG. 1).
For å gjenopprette, trykk på knappen 5 ganger i løpet av 3 sekunder, som angitt i FIG. 2, etter at feilen er fjernet.
PAS PÅ: Ved den type feil i forbindelsen kan man risikere, at produktet låses fast (FIG. 1).
- DK** For at genoprette funktionen skal man trykke knappen ind 5 gange i 3 sekunder, som vist i FIG. 2, efter at fejlen er blevet udbedret.
- S** **OBSERVERA!** Med detta fel finns det risk för att produkten blockeras (FIG. 1).
För att återställa efter att defekten har åtgärdats, tryck ned knappen 5 gånger i 3 sekunder som i FIG. 2.
- RUS** **ВНИМАНИЕ:** при наличии этой ошибки соединения продукт может заблокироваться (PVC. 1).
Для восстановления нажмите на кнопку 5 раз за 3 секунды, как указано на PVC. 2, после того как был устранен дефект.
- CN** 注意：出现这种故障时，灯具可能停止运行（1号图表）。
要重新启动，排除故障之后，请按照2号图表按按钮五次，每次三秒钟。

FIG. 1
FIG. 1
FIG. 1
ABB. 1
AFB. 1
FIG. 1
FIG. 1
FIG. 1
FIG. 1
1号图表

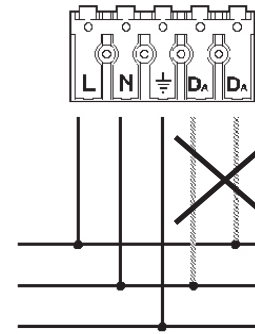

NO
NO
NON
NEIN
NEE
NO
NEI
NEJ
NEJ
HET
禁止

FIG. 2
FIG. 2
ABB. 2
AFB. 2
FIG. 2
FIG. 2
FIG. 2
2号图表



L
N
PE
禁止

2.509.216.00
IS05718/01

استبدال الضوء LED
SOSTITUZIONE DEL LED
REPLACING THE LED
REEMPLAZO DEL LED

تنبیه: لاستبدال الضوء LED اتصل بشركة iGuzzini .

I N.B.: Per la sostituzione del LED contattare l'azienda iGuzzini.

GB N.B.: For information on LED replacement please contact iGuzzini.

E NOTA: Para sustituir el LED llame a la empresa iGuzzini.

فئة الخطر 1 . حسب مقاييس EN 62471: 2008 .

I Gruppo di rischio 1, secondo norma EN 62471: 2008

GB Risk Group: 1, in compliance with Standard EN 62471: 2008

E Grupo de riesgo 1, según norma EN 62471: 2008

iGuzzini

2.509.216.00
IS05718/01

استبدال الضوء LED
SOSTITUZIONE DEL LED
REPLACING THE LED
REEMPLAZO DEL LED

تنبیه: لاستبدال الضوء LED اتصل بشركة iGuzzini .

I N.B.: Per la sostituzione del LED contattare l'azienda iGuzzini.

GB N.B.: For information on LED replacement please contact iGuzzini.

E NOTA: Para sustituir el LED llame a la empresa iGuzzini.

فئة الخطر 1 . حسب مقاييس EN 62471: 2008 .

I Gruppo di rischio 1, secondo norma EN 62471: 2008

GB Risk Group: 1, in compliance with Standard EN 62471: 2008

E Grupo de riesgo 1, según norma EN 62471: 2008

iGuzzini

2.509.216.00
IS05718/01

استبدال الضوء LED
SOSTITUZIONE DEL LED
REPLACING THE LED
REEMPLAZO DEL LED

تنبیه: لاستبدال الضوء LED اتصل بشركة iGuzzini .

I N.B.: Per la sostituzione del LED contattare l'azienda iGuzzini.

GB N.B.: For information on LED replacement please contact iGuzzini.

E NOTA: Para sustituir el LED llame a la empresa iGuzzini.

فئة الخطر 1 . حسب مقاييس EN 62471: 2008 .

I Gruppo di rischio 1, secondo norma EN 62471: 2008

GB Risk Group: 1, in compliance with Standard EN 62471: 2008

E Grupo de riesgo 1, según norma EN 62471: 2008

iGuzzini

2.509.216.00
IS05718/01

استبدال الضوء LED
SOSTITUZIONE DEL LED
REPLACING THE LED
REEMPLAZO DEL LED

تنبیه: لاستبدال الضوء LED اتصل بشركة iGuzzini .

I N.B.: Per la sostituzione del LED contattare l'azienda iGuzzini.

GB N.B.: For information on LED replacement please contact iGuzzini.

E NOTA: Para sustituir el LED llame a la empresa iGuzzini.

فئة الخطر 1 . حسب مقاييس EN 62471: 2008 .

I Gruppo di rischio 1, secondo norma EN 62471: 2008

GB Risk Group: 1, in compliance with Standard EN 62471: 2008

E Grupo de riesgo 1, según norma EN 62471: 2008

iGuzzini

2.509.216.00
IS05718/01

استبدال الضوء LED
SOSTITUZIONE DEL LED
REPLACING THE LED
REEMPLAZO DEL LED

تنبیه: لاستبدال الضوء LED اتصل بشركة iGuzzini .

I N.B.: Per la sostituzione del LED contattare l'azienda iGuzzini.

GB N.B.: For information on LED replacement please contact iGuzzini.

E NOTA: Para sustituir el LED llame a la empresa iGuzzini.

فئة الخطر 1 . حسب مقاييس EN 62471: 2008 .

I Gruppo di rischio 1, secondo norma EN 62471: 2008

GB Risk Group: 1, in compliance with Standard EN 62471: 2008

E Grupo de riesgo 1, según norma EN 62471: 2008

iGuzzini

ONLY FOR DALI PRODUCT

2.509.296.01
IS07392/01

iGuzzini

الشكل 1
FIG. 1



تنبيه: خطر حدوث عطل مع هذا الخطأ في التوصيل. (الشكل 1)
لإعادة التنشيط، اضغط على الزر 5 مرات في 3 ثوان كما هو موضح في الشكل 2، بعد التأكد من تلاشي الخطأ.

- I **ATTENZIONE:** con questo errore di collegamento il prodotto rischia di bloccarsi (FIG. 1).
Per ripristinare, premere il pulsante 5 volte in 3 secondi come in FIG. 2, dopo che il difetto è stato rimosso.
- GB **WARNING:** with this connection error the product risks to get blocked (FIG. 1).
To restore, press the button 5 times in 3 seconds as shown in FIG. 2, after removing the defect.
- E **ATENCIÓN:** con este error de conexión existe un riesgo de bloqueo del producto (FIG. 1).
Para restablecer, oprimir el pulsador 5 veces en 3 segundos según ilustrado en la FIG. 2, después de eliminar el defecto.

الشكل 2
FIG. 2

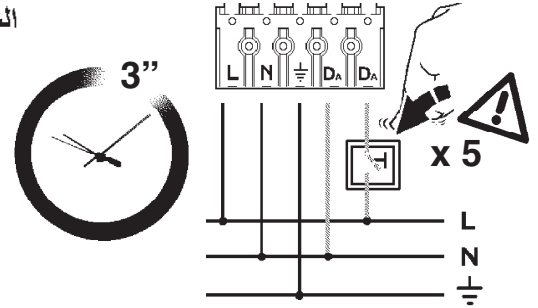

ONLY FOR DALI PRODUCT

2.509.296.01
IS07392/01

iGuzzini

الشكل 1
FIG. 1

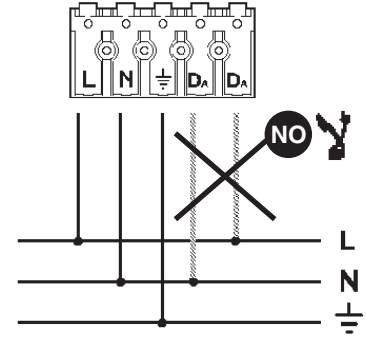

تنبيه: خطر حدوث عطل مع هذا الخطأ في التوصيل. (الشكل 1)
لإعادة التنشيط، اضغط على الزر 5 مرات في 3 ثوان كما هو موضح في الشكل 2، بعد التأكد من تلاشي الخطأ.

- I **ATTENZIONE:** con questo errore di collegamento il prodotto rischia di bloccarsi (FIG. 1).
Per ripristinare, premere il pulsante 5 volte in 3 secondi come in FIG. 2, dopo che il difetto è stato rimosso.
- GB **WARNING:** with this connection error the product risks to get blocked (FIG. 1).
To restore, press the button 5 times in 3 seconds as shown in FIG. 2, after removing the defect.
- E **ATENCIÓN:** con este error de conexión existe un riesgo de bloqueo del producto (FIG. 1).
Para restablecer, oprimir el pulsador 5 veces en 3 segundos según ilustrado en la FIG. 2, después de eliminar el defecto.

الشكل 2
FIG. 2

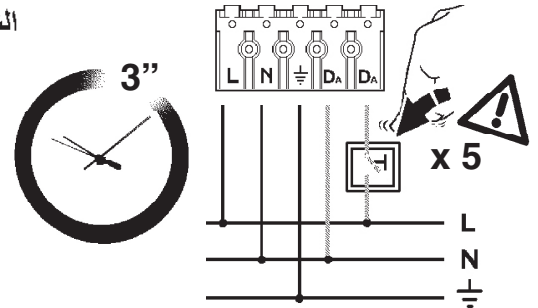

ONLY FOR DALI PRODUCT

2.509.296.01
IS07392/01

iGuzzini

الشكل 1
FIG. 1

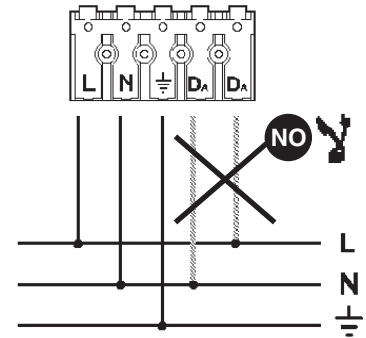

تنبيه: خطر حدوث عطل مع هذا الخطأ في التوصيل. (الشكل 1)
لإعادة التنشيط، اضغط على الزر 5 مرات في 3 ثوان كما هو موضح في الشكل 2، بعد التأكد من تلاشي الخطأ.

- I **ATTENZIONE:** con questo errore di collegamento il prodotto rischia di bloccarsi (FIG. 1).
Per ripristinare, premere il pulsante 5 volte in 3 secondi come in FIG. 2, dopo che il difetto è stato rimosso.
- GB **WARNING:** with this connection error the product risks to get blocked (FIG. 1).
To restore, press the button 5 times in 3 seconds as shown in FIG. 2, after removing the defect.
- E **ATENCIÓN:** con este error de conexión existe un riesgo de bloqueo del producto (FIG. 1).
Para restablecer, oprimir el pulsador 5 veces en 3 segundos según ilustrado en la FIG. 2, después de eliminar el defecto.

الشكل 2
FIG. 2

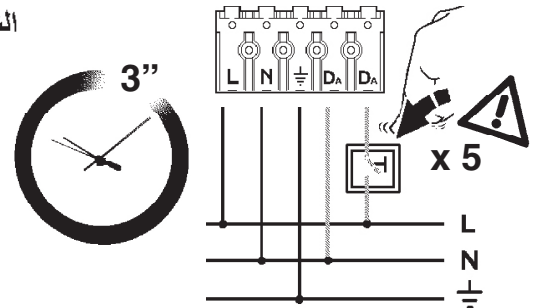

- I Istruzioni per le operazioni di servizio per l'apparecchio di illuminazione**
GB Instructions on luminaire service operations
F Instructions pour les opérations de service du luminaire
D Wartungsanleitung für die Leuchte
NL Instructies voor de onderhoudsoperaties op de verlichtingsarmatuur
E Instrucciones para las operaciones de servicio del aparato de alumbrado
DK Anvisninger i serviceindgreb på belysningsarmatur
N Anvisninger for betjening av lysapparatet
S Instruktioner för användning av belysningsanordningen
RUS Инструкция по эксплуатации осветительного прибора
CN 照明装置检修操作说明

Sostituire la lampada parzialmente esausta
 Replace the partly exhausted lamp
 Remplacer la lampe partiellement épuisée
 Die teilweise erschöpfte Lampe austauschen
 Vervang de gedeeltelijk lege lamp
 Sustituir la lámpara parzialmente agotada
 Udskift den delvist udtjente pære
 Skifte ut den delvis utbrente lyspæren
 Byt ut den delvis förbrukade lampan
 Замена частично отработанной лампочки
 更换部分老化的灯泡



Spegnimento
 Switch it off
 Extinction
 Ausschaltung
 Uitschakeling
 Apagado
 Slukning
 Slukking
 Släckning
 Выключение
 关灯

Interrompere l'alimentazione dell'apparecchio
 Cut the power supply to the luminaire
 Couper l'alimentation du luminaire
 Stromversorgung der Leuchte unterbrechen
 Onderbreek de voeding van het apparaat
 Interrumpir la alimentación del aparato
 Afbryd armaturets strømforsyning
 Avbryt strømtilførselen til apparatet
 Koppla från anordningens strömförsörjning
 Отключить электропитание прибора
 中断装置供电



Aprire l'apparecchio
 Open the fixture
 Ouvrir le luminaire
 Das Gerät öffnen
 Open het apparaat
 Abrir el aparato
 Åbn armaturet
 Åpne apparatet
 Öppna anordningen
 Раскрыть прибор
 打开装置



Rimuovere la lampada esausta
 Remove the exhausted lamp
 Retirer la lampe épuisée
 Die alte Lampe entnehmen
 Verwijder de lege lamp
 Quitar la lámpara agotada
 Tag den udtjente pære ud
 Fjerne den utbrente lyspæren
 Ta bort den förbrukade lampan
 Вынуть старую лампочку
 取出老化的灯泡

Portarla in un centro di riciclaggio
 Carry it to a recycling centre
 La porter dans une déchetterie pour son recyclage
 Ordnungsgemäß entsorgen
 Breng de lamp naar een recyclingcentrum
 Llevarla a un centro de reciclaje
 Aflever den på en genbrugsstation
 Lever den til en miljøstasjon
 Lämna in den till en återvinningsanläggning
 Сдать ее в пункт приема утильсырья
 将其送往回收中心

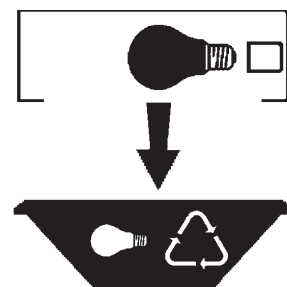

Inserire la nuova lampada
 Introduce the new lamp
 Installer la lampe neuve
 Die neue Lampe einsetzen
 Doe de nieuwe lamp op zijn plek
 Montar la nueva lámpara
 Sæt den nye pære i
 Sette i den nye pæren
 Sätt i den nya lampan
 Вставить новую лампочку
 装入新灯泡

Inserire la nuova lampada nel portalampana
 Fit the new lamp into the socket
 Installer la nouvelle lampe dans le support de lampe
 Die neue Lampe in den Sockel einsetzen
 Doe de nieuwe lamp in de lamphouder
 Montar la nueva lámpara en el portalampana
 Sæt den nye pære i fatningen
 Sette den nye pæren inn i lampeholderen
 Sätt i den nya lampan i lamphållaren
 Вставить новую лампочку в патрон
 将新灯泡插入灯泡架中



Riposizionare ottica
 Re-place the optic
 Remettre l'optique à sa place
 Die Optik wieder einsetzen
 Doe de optiek weer op zijn plaats
 Volver a montar la óptica
 Sæt den optiske enhed på plads
 Innstille linsen
 Flytta om optiken
 Отрегулировать линзы
 重新定位光头



Effettuare prova di funzionamento
 Perform operative test
 Procéder à un essai de fonctionnement
 Eine Funktionsprüfung durchführen
 Controleer de correcte werking
 Hacer una prueba de funcionamiento
 Afprøv funktionen
 Prøve om den fungerer
 Utför funktionstest
 Выполнить проверку исправности работы
 执行功能测试



I Istruzioni per la pulizia dell'apparecchio di illuminazione
 GB Instructions on luminaire cleaning operations
 F Instructions pour le nettoyage du luminaire
 D Anweisungen zur Reinigung der Leuchte
 NL Instructies voor de reiniging van de verlichtingsarmatuur
 E Instrucciones para limpiar el aparato de alumbrado
 DK Anvisninger i rengøring af belysningsarmaturet
 N Anvisninger for rengjøring av lysapparatet
 S Instruktioner för rengöring av belysningsanordningen
 RUS Инструкции по чистке осветительного прибора
 CN 照明装置清洁说明

Pulire l'apparecchio
 Clean the fixture
 Nettoyer le luminaire
 Das Gerät reinigen
 Reinig het apparaat
 Limpiar el aparato
 Rengør armaturet
 Rengjøre apparatet
 Rengör anordningen
 Чистка прибора
 清洁装置



Spegnimento
 Switch it off
 Extinction
 Ausschaltung
 Uitschakeling
 Apagado
 Slukning
 Slukking
 Släckning
 Выключение
 关灯

Interrompere l'alimentazione dell'apparecchio
 Cut the power supply to the luminaire
 Couper l'alimentation du luminaire
 Stromversorgung der Leuchte unterbrechen
 Onderbreek de voeding van het apparaat
 Interrumpir la alimentación del aparato
 Afbryd armaturets strømforsyning
 Avbryt strømtilførselen til apparatet
 Koppla från anordningens strömförsörjning
 Отключить электропитание прибора
 中断装置供电



Spolverare l'ottica esterna
 Remove dust from the external optic
 Dépoussiérer l'optique extérieure
 Die externe Optik abstauben
 Stof de externe optiek af
 Quitar el polvo de la óptica exterior
 Tør støvet af den udvendige optiske enhed
 Fjerne støv fra den eksterne lysenheten
 Damma av den yttre optiken
 Вытереть пыль с внешней стороны линз
 为外侧光头掸尘

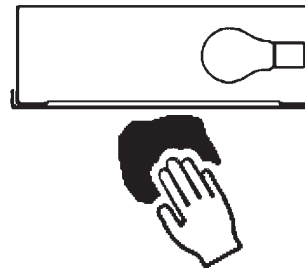

Lavare l'ottica esterna
 Wash the external optic
 Laver l'optique extérieure
 Die externe Optik waschen
 Was de externe optiek
 Lavar la óptica exterior
 Vask den udvendige optiske enhed
 Vaske den eksterne lysenheten
 Rengör den yttre optiken
 Вымыть линзы с внешней стороны
 清洁外光头



Rimuovere l'ottica
 Remove the optic
 Retirer l'optique
 Die Optik abnehmen
 Verwijder de optiek
 Quitar la óptica
 Tag den optiske enhed af
 Fjerne lysenheten
 Ta bort optiken
 Снять линзы
 取下光头



Pulire la parte interna dell'apparecchio di illuminazione
 Clean the inside of the fixture
 Nettoyer l'intérieur du luminaire
 Die Innenseite der Leuchte reinigen
 Reinig de binnenzijde van de verlichtingsarmatuur
 Limpiar el interior del aparato de alumbrado
 Rengør belysningsarmaturets indvendige dele
 Rengjøre lysapparatet innvendig
 Rengör belysningsanordningen invändigt
 Протереть осветительный прибор изнутри
 清洁照明装置内部



Riposizionare ottica
 Re-place the optic
 Remettre l'optique à sa place
 Die Optik wieder einsetzen
 Doe de optiek weer op zijn plaats
 Volver a montar la óptica
 Sæt den optiske enhed på plads
 Innstille linsen
 Flytta om optiken
 Отрегулировать линзы
 重新定位光头



Effettuare prova di funzionamento
 Perform operative test
 Procéder à un essai de fonctionnement
 Eine Funktionsprüfung durchführen
 Controleer de correcte werking
 Hacer una prueba de funcionamiento
 Afprøv funktionen
 Prøve om den fungerer
 Utför funktionstest
 Выполнить проверку исправности работы
 执行功能测试



- I** Istruzioni per il fine vita e lo smaltimento dei componenti
GB Instructions on end-of-life and component disposal
F Instructions pour la gestion des composants en fin de vie et leur mise au rebut
D Anweisungen zur Entsorgung der Leuchtenkomponenten
NL Instructies voor het verwijderen van de armatuur en het recyclen van de onderdelen
E Instrucciones para el final de vida y la eliminación los componentes
DK Anvisninger i udtjent armatur og bortskaffelse af komponenter
N Anvisninger for endt levetid og avfallsbehandling av delene
S Instruktioner vid bortskaffning och kassering av komponenter
RUS Инструкции по утилизации прибора и его комплектующих по окончании его срока службы
CN 寿命期结束与零件废弃处置说明

| | | | |
|---|--|--|--|
| <p>Spegnimento Switch it off Extinction Ausschaltung Uitschakeling Apagado Slukning Slukking Släckning Выключение 关灯</p> <p>Interrompere l'alimentazione dell'apparecchio Cut the power supply to the luminaire Couper l'alimentation du luminaire Stromversorgung der Leuchte unterbrechen Onderbreek de voeding van het apparaat Interrompirla alimentación del aparato Afbryd armaturets strømforsyning Avbryt strømtilførselen til apparatet Koppla från anordningens strömförsörjning Отключить электропитание прибора 中断装置供电</p>  | <p>Rimuovere la/e lampada/e per la dismissione Remove the lamp(s) for decommissioning Retirer la(les) lampe(s) pour sa(leur) mise au rebut Die Lampe/n ordnungsgemäß entsorgen Verwijder de lamp(en) voor het recyclen Quitar la(s) lámpara(s) para el desecho Tag pæren/pærerne ud til bortskaffelse Fjerne lampen/-e som skal kastes Ta bort lampan/-orna för bortskaffningen Вынуть лампочку/и для утилизации прибора 取出需要丢弃的灯泡</p>  | <p>Rimuovere la batteria per la dismissione Remove the battery for decommissioning Retirer la batterie pour sa mise au rebut Die Batterie ordnungsgemäß entsorgen Verwijder de batterij voor het recyclen Quitar la batería para el desecho Tag batteriet ud til bortskaffelse Fjerne batteriet som skal kastes Ta bort batteriet för bortskaffningen Вынуть батарейку для утилизации прибора 取出需要丢弃的电池</p>  | <p>Rimuovere l'apparecchio per la dismissione Remove the fixture for decommissioning Enlever le luminaire pour sa mise au rebut Das Gerät ordnungsgemäß entsorgen Verwijder het apparaat voor het recyclen Quitar el aparato para el desecho Tag armaturet ud til bortskaffelse Fjerne apparatet som skal kastes Ta bort anordningen för bortskaffningen Снять прибор для утилизации 取出需要丢弃的装置</p>  |
|---|--|--|--|

| | | | |
|--|--|--|--|
| <p>Inviare i materiali ad un centro di raccolta RAEE Send the materials to a WEEE collection centre Envoyer les matériaux dans une déchetterie DEEE Die Materialien in einem WEEE-Zentrum entsorgen Zend de materialen naar een recyclingscentrum voor de AEEA Enviar los materiales a un centro de recogida RAEE Afløver materialerne på et indsamlingscenter for elektronisk udstyr Sende materialene til en miljøstasjon for resirkulering av EE-avfall Skicka materialet till en RAEE uppsamlingscentral Сдать материалы в пункт приема утильсырья 将材料送往电气和电子垃圾回收中心</p>  | | | |
|--|--|--|--|