

iWAY

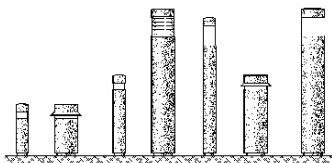

POSIZIONE D'INSTALLAZIONE
INSTALLATION POSITION
POSITION D'INSTALLATION
INSTALLATIONSPOSITION
INSTALLERINGPOSITIE
POSICION DE INSTALACION
INSTALLATIONSPOSITION
INSTALLATIONSPOSITION
INSTALLATIONSPOSITION
INSTALLATIONSPOSITION
MONTAJNE POLOZENIE
安装位置

Pag. 1

INTERASSI DI FORATURA
CENTRE TO CENTRE DISTANCE BETWEEN HOLES
ENTRE-AXES DE PERCAGE
ABSTAND DER BOHRLÖCHER
AFSTANDEN TUSSEN DE GATEN
DISTANCIA ENTRE LOS EJES DE PERFORACIÓN
HULAFSTAND
AVSTANDER FRA SENTER TIL SENTER MELLOM HULL
AVSTÅND MELLAN HÅL
ШАГ ОТВЕРСТИЙ
孔间的中心距离

Pag. 2

CABLAGGIO ELETTRICO
ELECTRIC WIRING
CABLAGE ÉLECTRIQUE
ELEKTRISCHE VERKABELUNG
DE ELEKTRISCHE INSTALLERING
CABLAJE ELÉCTRICOELEKTRISK LEDNINGSFØRING
ELEKTRISK KABELING
ELEKTRISK KABELDRAGNING
МОНТАЖ КАБЕЛЬНОЙ ПРОВОДКИ
布线

Pag. 3

INSTALLAZIONE E SOSTITUZIONE DELLA LAMPADA
INSTALLING AND REPLACING THE LAMP
INSTALLATION ET REMPLACEMENT DE LA LAMPE
EINSETZEN UND AUSTAUSCHEN DER LEUCHE
HET INSTALLEREN EN VERVANGEN VAN DE LAMP
INSTALACIÓN Y REEMPLAZO DEL FOCO
INSTALLATION OG UDSKIFTNING AF LYSKILDEN
INSTALLERE OG SKIFTE LAMPEN
INSTALLATION OCH BYTE AV LAMPA
МОНТАЖ И ЗАМЕНА ЛАМПА
安装和更换光源

Pag. 8

INSTALLAZIONE E SOSTITUZIONE DEL VETRO DI PROTEZIONE
INSTALLING AND REPLACING THE PROTECTION GLASS
INSTALLATION ET REMPLACEMENT DU VERRE DE PROTECTION
INSTALLATION UND AUSWECHSELN DES SCHUTZGLASES
HET INSTALLEREN EN VERVANGEN VAN HET PROTEKIEGLAS
INSTALACIÓN Y REEMPLAZO DEL CRISTAL DE PROTECCION
INSTALLATION OG UDSKIFTNING AF BESKYTTELSESGLAS
INSTALLERE OG SKIFTE UT BESKYTTELSESGLASSET
INSTALLATION OCH BYTE AV SKYDDSGLAS
УСТАНОВКА И ЗАМЕНА ЗАЩИТНОГО СТЕКЛА
防护玻璃的安装与拆卸

Pag. 10

INSTALLAZIONE DEGLI ACCESSORI
INSTALLING THE ACCESSORIES
INSTALLATION DES ACCESSOIRES
INSTALLATION DER ZUBEHÖRTEILE
HET INSTALLEREN VAN DE ACCESSOIRES
INSTALACION DE ACCESORIOS
INSTALLATION AF TILBEHØR
INSTALLERING AV TILBEHØRET
INSTALLATION AV TILLBEHÖR
МОНТАЖ ВСПОМОГАТЕЛЬНЫХ КОМПЛЕКТУЮЩИХ
配件安装

Pag. 10

ATTENZIONE:
LA SICUREZZA DELL'APPARECCHIO E' GARANTITA SOLO CON L'USO APPROPRIATO DELLE SEGUENTI ISTRUZIONI; PERTANTO E' NECESSARIO CONSERVARLE.

WARNING:
THE SAFETY OF THIS FIXTURE IS GUARANTEED ONLY IF YOU COMPLY WITH THESE INSTRUCTIONS; REMEMBER TO CONSERVE IN A SAFE PLACE.

ATTENTION:
LA SECURITE DE L'APPAREIL N'EST GARANTIE QU'EN CAS D'UTILISATION CORRECTE DES INSTRUCTIONS SUIVANTES; IL FAUT PAR CONSEQUENT LES CONSERVER.

ACHTUNG:
DIE SICHERHEIT DES GERÄTES WIRD NUR DURCH SACHGEMÄSSE BEFOLGUNG NACHSTEHENDER ANWEISUNGEN GEWÄHRLEISTET; IHRE AUFBEWAHRUNG IST DESHALB SEHR WICHTIG.

OPGELET:
DE VEILIGHEID VAN DI ATOESTEL IS SLECHTS DAN GEGARANDEERD ALS INDIEN DE VOLGENDE INSTRUC-TIES STRIKT WORDEN TOEGEPAST; DAAROM MOET MEN ZE OOK BEWAREN.

ATENCIÓN:
LA SEGURIDAD DEL APARATO SE GARANTIZA SOLO CUMPLIENDO CUIDADOSAMENTE LAS SIGUIENTES INSTRUCCIONES; POR ELLO, ES NECESARIO CONSERVARLAS.

BEMÆRK:
SIKKERHEDEN VED BRUG AF ARMATURET KAN KUN GARANTERES, HVIS DISSE ANVISNINGER FØLGES; SØRG DERFOR FOR AT GEMME DEM.

ADVARSEL:
SIKKERHETEN I DETTE APPARATET GARANTERES KUN HVIS DU OVERHOLDER DISSE INSTRUKSJONENE; HUSK Å OPPBEVARE DEM PÅ ET TRYGT STED.

OBSERVERA!
UTRUSTNINGENS SÄKERHET KAN ENDAST GARANTERAS OM DESSA ANVISNINGAR RESPEKTERAS I DETALJ. SPARA DÄRFÖR DESSA ANVISNINGAR FÖR FRAMTIDA KONSULTATION.

ВНИМАНИЕ:
МЫ ГАРАНТИРУЕМ БЕЗОПАСНУЮ ЭКСПЛУАТАЦИЮ ИЗДЕЛИЯ ТОЛЬКО ПРИ СОБЛЮДЕНИИ СЛЕДУЮЩИХ ИНСТРУКЦИЙ; С ЭТОЙ ЦЕЛЬЮ НЕОБХОДИМО СОХРАНИТЬ ДАННУЮ БРОШЮРУ.

警告
为确保该装置安全，请遵守操作指示；并于安全场所放置。

N.B.: DURANTE L'INSTALLAZIONE DEL SISTEMA "iWAY" RISPETTARE SCRUPOLOSAMENTE LE NORME IMPIANTISTICHE NAZIONALI VIGENTI.

N.B.: WHEN INSTALLING THE "iWAY" SYSTEM, MAKE SURE ALL CURRENT NATIONAL REGULATIONS RELATING TO INSTALLATION ARE OBSERVED.

N.B.: LORS DE L'INSTALLATION DU SYSTÈME "iWAY" VEUILLEZ RESPECTER RIGOREUSEMENT LES NORMES EN VIGUEUR EN LA MATIÈRE DANS LE PAYS.

N.B.: BEACHTEN SIE BEI DER INSTALLATION DES SYSTEMS "iWAY" UNBEDINGT DIE IM LAND GELTENDEN ANLAGETECHNISCHEN VORSCHRIFTEN.

N.B.: BIJ HET INSTALLEREN VAN HET "iWAY" SYSTEEM MOET U DE GELDENDE NATIONALE INSTALLATIENORMEN STRIKT NALEVEN.

NOTA: DURANTE LA INSTALACIÓN DEL SISTEMA "iWAY" RESPETAR ESCRUPULOSAMENTE LAS NORMAS NACIONALES DE INSTALACIÓN EN VIGOR.

N.B.: UNDER INSTALLATION AF "iWAY" SYSTEMET SKAL MAN NØJE OVERHOLDE DE GÆLDENDE REGLER FOR DISSE ANLÆG.

N.B.: UNDER INSTALLASJON AV SYSTEMET "iWAY" MÅ DEN NASJONALE ANLEGGSFORSKRIF-TENE OVERHOLDES NØYE.

OBS! UNDER INSTALLATIONEN AV SYSTEMET "iWAY" SKA GÄLLANDE NATIONELLA IN-STALLATIONSFÖRESKRIFTER RESPEKTERAS I DETALJ.

ПРИМЕЧАНИЕ: В ПРОЦЕССЕ МОНТАЖА СИСТЕМЫ "iWAY" СТРОГО СОБЛЮДАЙТЕ НАЦИОНАЛЬНЫЕ ДЕЙСТВУЮЩИЕ НОРМАТИВЫ ПО ЭЛЕКТРОПРОВОДКЕ.

注意：安装 "iWAY" 系统时请务必遵守系统标准。

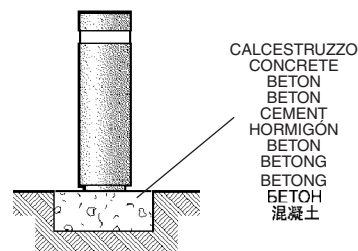
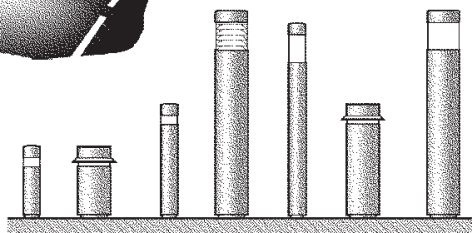
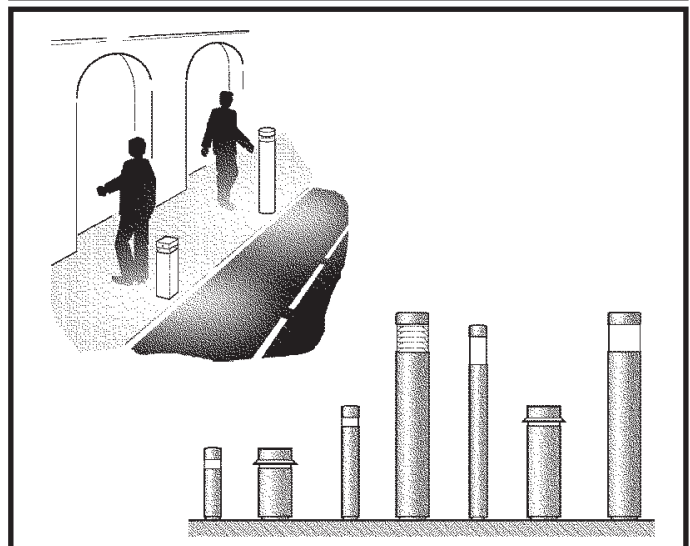
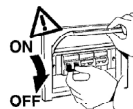

CALCESTRUZZO
CONCRETE
BETON
CEMENT
HORMIGÓN
BETON
BETONG
BETONG
BETONH
混凝土

I N.B.: Installando l'apparecchio, evitare che la base venga interrata o posizionata in punti soggetti al ristagno dell'acqua.

GB N.B.: Whilst installing the appliance, avoid concealing its base or placing it in areas which are susceptible to damp.

F N.B.: Lors de l'installation de l'appareil, veillez à ce que la base ne soit pas enterrée ou positionnée dans un endroit sujet à la stagnation de l'eau.

D N.B.: Bei der Installation des Gerätes ist darauf zu achten, daß das Unterteil nicht eingegraben oder an Stellen placiert wird, an denen sich Wasser stauen könnte.

NL N.B.: Het apparaat mag niet met de basis ingebouwd worden of op punten geïnstalleerd die stilstaand water veroorzaken.

E NOTA: Al instalar el aparato, evite que la base se entierre o se coloque en puntos donde se pueda estancar el agua.

DK N.B.: Ved installation af armaturet skal man undgå, at soklen er under niveau eller placeres på et sted, hvor der ophobes vand.

N N.B.: Under installasjon av apparatet, unngå å skjule basen eller plassere den på områder som er utsatt for damp.

S OBS! När utrustningen installeras ska du undvika att basen hamnar under marken eller placeras på ställen där vatten ansamlas.

RUS ПРИМЕЧАНИЕ: При монтаже прибора следует избегать зарывания в почву или установки его основания в местах, подверженных затоплению.

CN 注意：安装该灯具时，避免隐藏底座或将灯具放置在易受潮的区域。

art. B461
B462 - B463 - B464
B465 - B466 - B467
B473 - B474 - B475
B476 - B477 - B478
B633 - B634 - B635
B636 - B637 - B638
BG25 - BG29 - BG23
BG24 - MR81 - MR82
MR83 - MR84 - BW60
BW61 - BW62 - BW63
BW64 - BW65 - BW74
BW75 - BW76 - BW77
BW78 - BW79

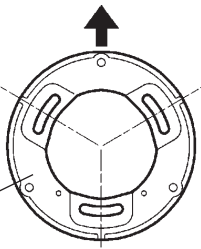

LATO PEDONALE O CARRABILE
PEDESTRIAN OR VEHICULAR SIDE
CÔTÉ PIÉTONS OU VOITURES
FUSSGÄNGER- ODER FAHRWEGSEITE
VOETGANGERSZIJDE OF BERIJDBARE ZIJDE
LADO PEATONAL O VEHICULAR
GANGSTI ELLER KØREBANE
FOTGJENGER- ELLER KØRETØYSIDE
SIDA FØR FOTGÅNGARE ELLER FORDON
ПЕШЕХОДНАЯ ИЛИ ПРОЕЗЖАЯ СТОРОНА
行人或机动车侧

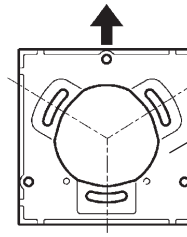

art. B481
B482 - B483 - B484
B485 - B486 - B487
B641 - B642 - B643
B644 - B645 - B646
BG28 - BG30 - BG26
BG27 - MR85 - MR86
MR87 - MR88 - BW66
BW67 - BW68 - BW69
BW70 - BW71 - BW80
BW81 - BW82 - BW83
BW84 - BW85

PER IL FISSAGGIO SI CONSIGLIA DI UTILIZZARE TASSELLI PER ANCORAGGI PESANTI TIPO FZA- I- M 8 FISCHER, O SIMILARI ANCHE DI ALTRI COSTRUTTORI.

FOR FIXING USE HEAVY DUTY PLUGS, SUCH AS FZA- I- M 8 FISCHER OR SIMILAR, INCLUDING FROM OTHER MANUFACTURERS.

POUR LA FIXATION, IL EST CONSEILLÉ D'UTILISER DES CHEVILLES POUR ANCRAGES LOURDS DE TYPE FZA- I- M 8 FISCHER OU SIMILAIRES (D'AUTRES FABRICANTS AUSSI).

ZUR BEFESTIGUNG EMPFEHLEN WIR, STARKE VERANKERUNGSDÜBEL ZU VERWENDEN, ZUM BEISPIEL VOM TYP FZA- I- M 8 VON FISCHER ODER ENTSPRECHENDE PRODUKTE VON ANDEREN HERSTELLERN.

VOOR DE BEVESTIGING RADEN WIJ U AAN PLUGGEN VOOR ZWARE VERANKERINGEN TE GEBRUIKEN, ZOALS HET TYPE FZA- I- M 8 FISCHER OF DERGELIJKE, OOK VAN ANDERE PRODUCTENTEN.

PARA LA FIJACIÓN SE RECOMIENDA UTILIZAR TACOS PARA ANCLAJES DE GRAN RESISTENCIA, TIPO FZA- I- M 8 FISCHER, O SIMILARES, INCLUIDO DE OTROS FABRICANTES.

VED MONTERING ANBEFALES BRUG AF RAWLPLUGS TIL TUNGE EMNER AF TYPEN FZA- I- M 8 FISCHER, ELLER LIGNENDE FRA ANDRE FABRIKANTER.

FOR FESTE BRUKES HØYTYTELSE PLUGGER, SLIK SOM FZA- I- M 8 FISCHER ELLER LIGNENDE, INKLUDERT FRA ANDRE PRODUSENTER.

FÖR FASTSÄTTNINGEN REKOMMENDERAS ATT ANVÄNDA PLUGGAR FÖR FASTSÄTTNING AV TYNGRE FÖREMÅL AV TYP FZA- I- M 8 FISCHER, ELLER LIKNANDE AV ANNAT MÄRKE.

ДЛЯ КРЕПЛЕНИЯ РЕКОМЕНДУЕТСЯ ИСПОЛЬЗОВАТЬ ВКЛАДЫШИ ДЛЯ ТЯЖЕЛОГО КРЕПЛЕНИЯ ТИПА FZA- I- M 8 FISCHER ИЛИ ПОДОБНЫЕ ДРУГИХ МАРК.

进行固定时，使用大载流插头，例如 FZA- I- M 8 FISCHER 或 SIMILAR，也包括其他生产商提供的插头。

INSTALLAZIONE CON L'ART. B513 - INSTALLATION WITH ART. B513
INSTALLATION AVEC L'ART. B513 - MONTAGE MIT ART. B513
HET INSTALLEREN MET ART. B513 - INSTALACION CON ART. B513
МОНТАЖ С ИЗДЕЛИЕМ B513 安裝ART. B513

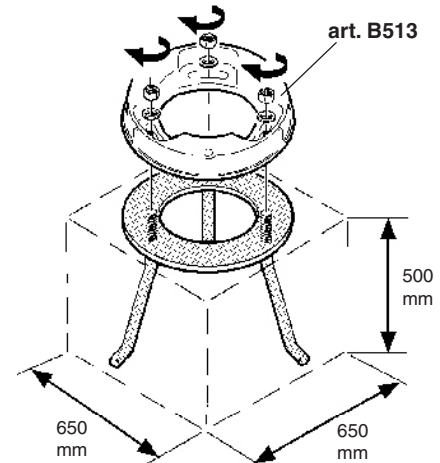
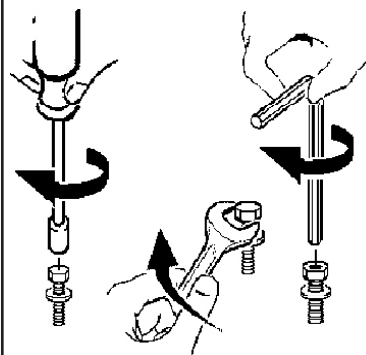
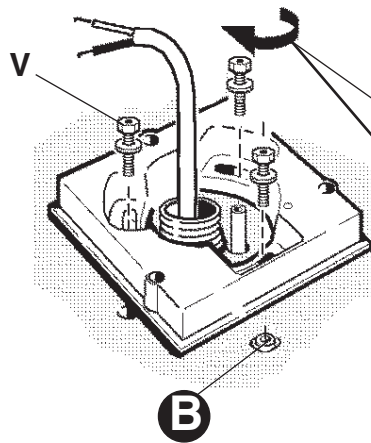
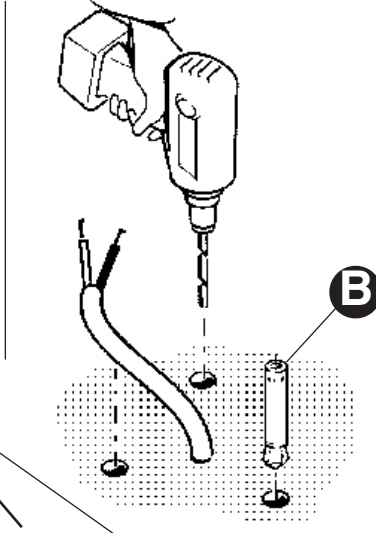
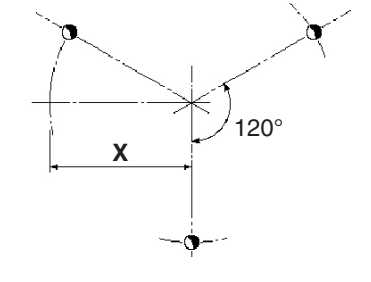
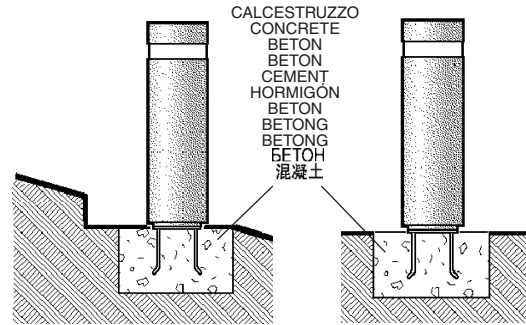

ART.	X (mm)	V (mm)	art.
B461 - B462 - B463 - B464 - B465 B466 - B467 - B474 - B473 - B475 B476 - B477 - B478 - B481 - B482 B483 - B484 - B485 - B486 - B487 B633 - B634 - B635 - B636 - B637 B638 - B641 - B642 - B643 - B644 B645 - B646 - BG23 - BG24 - BG25 BG28 - BG26 - BG27 - BG29 - BG30 MR81 - MR82 - MR83 - MR84 - MR85 MR86 - MR87 - MR88 - BW60 - BW61 BW62 - BW63 - BW64 - BW65 - BW74 BW75 - BW76 - BW77 - BW78 - BW79 BW66 - BW67 - BW68 - BW69 - BW70 BW71 - BW80 - BW81 - BW82 - BW83 BW84 - BW85	56	M 8	B513

I N.B.: Le dimensioni del Plinto sono fornite a titolo indicativo, sono state calcolate considerando un terreno con pressione ammissibile di 1,0bar (1,0 kg /cm²)

GB N.B.: The dimensions of the plinth are purely indicative and were calculated taking into account a surface with an allowable pressure of 1.0 bar (1.0 kg/cm²)

F N.B.: Les dimensions du massif de fondation sont fournies à titre indicatif et ont été calculées en tenant compte d'un sol dont la pression admise est égale à 1,0 bar (1,0 kg /cm²)

D N.B.: Die Abmessungen der Plinthe sind als Richtwert angegeben und wurden für ein Gelände mit zulässigem Druck von 1,0 bar (1,0 kg /cm²) berechnet

NL N.B.: De afmetingen van Plinto zijn slechts als voorbeeld verschaft. Zij zijn berekend op basis van een bodem met een toegestane druk van 1,0 bar (1,0 kg/cm²).

E NOTA: Las medidas de Plinto son sólo indicativas, han sido calculadas considerando un terreno con presión admisible de 1,0bar (1,0 kg /cm²)

DK N.B.: Dimensionerne på Plinto er omtrentlige. De er beregnet ud fra et maks. tilladt jordtryk på 1,0 bar (1,0 kg /cm²)

N N.B.: Størrelsen på pilaren gis kun som et eksempel, den er utregnet på grunnlag av et terreng med et tillatt trykk på 1,0 bar (1,0 kg /cm²)

S OBS! Måtten som anges för Plinto är endast ungefärliga och har beräknats på en mark med ett tillåtet tryck på 1,0 bar (1,0 kg /cm²)

RUS ПРИМЕЧАНИЕ: Размеры Plinto, приведенные только в качестве примера, были рассчитаны с учетом почвы с допустимым давлением 1,0 бар (1,0 кг/см²)

CN 注意：底座的外形尺寸完全是参考性的并且表面的容许压力1.0 bar (1.0 kg/cm²)要被计算考虑在内。

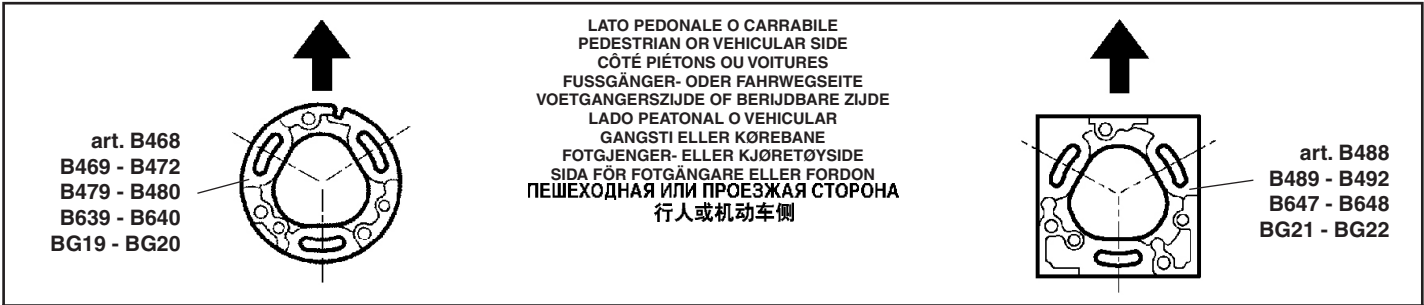

art. B468
B469 - B472
B479 - B480
B639 - B640
BG19 - BG20

LATO PEDONALE O CARRABILE
PEDESTRIAN OR VEHICULAR SIDE
CÔTÉ PIÉTONS OU VOITURES
FUSSGÄNGER- ODER FAHRWEGSEITE
VOETGANGERSZIJDE OF BERIJDBARE ZIJDE
LADO PEATONAL O VEHICULAR
GANGSTI ELLER KJØREBANE
FOTGJENGER- ELLER KJØRETOYSIDE
SIDA FÖR FOTGÅNGARE ELLER FORDON
ПЕШЕХОДНАЯ ИЛИ ПРОЕЗЖАЯ СТОРОНА
行人或机动车侧

art. B488
B489 - B492
B647 - B648
BG21 - BG22

PER IL FISSAGGIO SI CONSIGLIA DI UTILIZZARE TASSELLI PER ANCORAGGI PESANTI TIPO **FZA- I- M 6** FISCHER, O SIMILARI ANCHE DI ALTRI COSTRUTTORI.
FOR FIXING USE HEAVY DUTY PLUGS, SUCH AS **FZA- I- M 6** FISCHER OR SIMILAR, INCLUDING FROM OTHER MANUFACTURERS.
POUR LA FIXATION, IL EST CONSEILLÉ D'UTILISER DES CHEVILLES POUR ANCRAGES LOURDS DE TYPE **FZA- I- M 6** FISCHER OU SIMILAIRES (D'AUTRES FABRICANTS AUSSI).
ZUR BEFESTIGUNG EMPFEHLEN WIR, STARKE VERANKERUNGSDÜBEL ZU VERWENDEN, ZUM BEISPIEL VOM TYP **FZA- I- M 6** VON FISCHER ODER ENTSPRECHENDE PRODUKTE VON ANDEREN HERSTELLERN.
VOOR DE BEVESTIGING RADEN WIJ U AAN PLUGGEN VOOR ZWARE VERANKERINGEN TE GEBRUIKEN, ZOALS HET TYPE **FZA- I- M 6** FISCHER OF DERGELIJKE, OOK VAN ANDERE PRODUCTEN.
PARA LA FIJACIÓN SE RECOMIENDA UTILIZAR TACOS PARA ANCLAJES DE GRAN RESISTENCIA, TIPO **FZA- I- M 6** FISCHER, O SIMILARES, INCLUSO DE OTROS FABRICANTES.
VED MONTERING ANBEFALES BRUG AF RAWLPLUGS TIL TUNGE EMNER AF TYPEN **FZA- I- M 6** FISCHER, ELLER LIGNENDE FRA ANDRE FABRIKANTER.
FOR FESTE BRUKES HØYTTELSESLUGGER, SLIK SOM **FZA- I- M 6** FISCHER ELLER LIGNENDE, INKLUDERT FRA ANDRE PRODUSENTER.
FÖR FASTSÄTTNINGEN REKOMMENDAS ATT ANVÄNDA PLUGGAR FÖR FASTSÄTTNING AV TYNGRE FÖREMÅL AV TYP **FZA- I- M 6** FISCHER, ELLER LIKNANDE AV ANNAT MÄRKE.
ДЛЯ КРЕПЛЕНИЯ РЕКОМЕНДУЕТСЯ ИСПОЛЬЗОВАТЬ ВКЛАДЫШИ ДЛЯ ТЯЖЕЛОГО КРЕПЛЕНИЯ ТИПА **FZA- I- M 6** FISCHER ИЛИ ПОДОБНЫЕ ДРУГИХ МАРОК.
进行固定时，使用大载流插头，例如 **FZA- I- M 6** FISCHER 或 SIMILAR，也包括其他生产商提供的插头。

INSTALLAZIONE CON L'ART. B514 - INSTALLATION WITH ART. B514
INSTALLATION AVEC L'ART. B514 - MONTAGE MIT ART. B514
HET INSTALLEREN MET ART. B514 - INSTALACION CON ART. B514
МОНТАЖ С ИЗДЕЛИЕМ B514 安装ART. B514

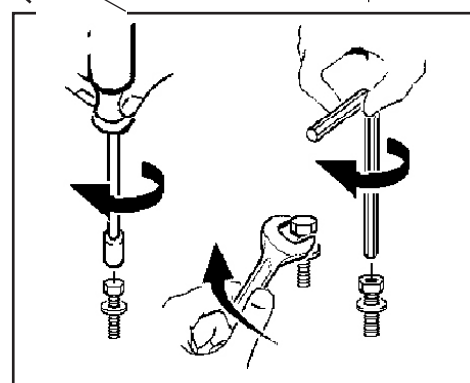
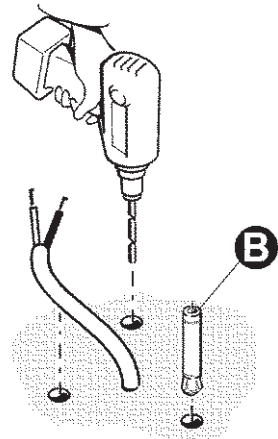
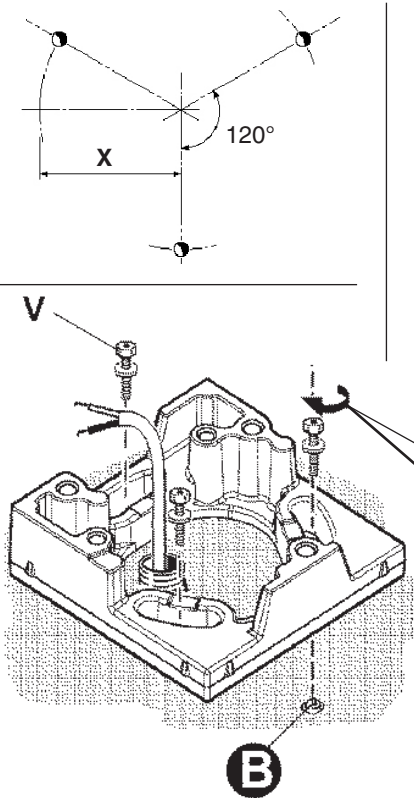
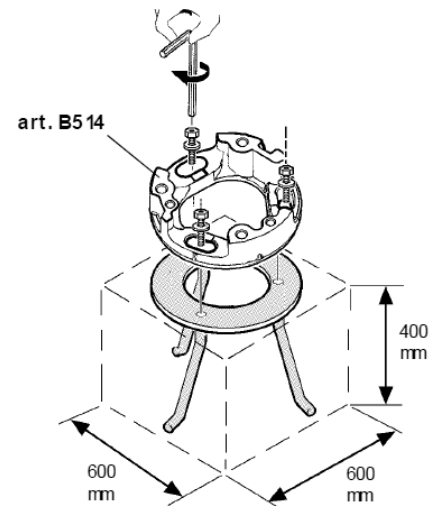
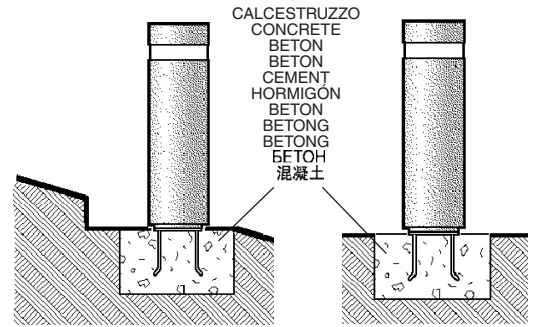

ART.	X (mm)	V (mm)	art.
B468 - B469 B472 - B479 B480 - B488 - B489 B492 - B639 - B640 B647 - B648 BG19 - BG20 BG21 - BG22	32	M 6	B514

I N.B.: Le dimensioni del Plinto sono fornite a titolo indicativo, sono state calcolate considerando un terreno con pressione ammissibile di 1,0bar (1,0 kg /cm²)
GB N.B.: The dimensions of the plinth are purely indicative and were calculated taking into account a surface with an allowable pressure of 1.0 bar (1.0 kg/cm²)
F N.B.: Les dimensions du massif de fondation sont fournies à titre indicatif et ont été calculées en tenant compte d'un sol dont la pression admise est égale à 1,0 bar (1,0 kg /cm²)
D N.B.: Die Abmessungen der Plinthe sind als Richtwert angegeben und wurden für ein Gelände mit zulässigem Druck von 1,0 bar (1,0 kg /cm²) berechnet
NL N.B.: De afmetingen van Plinto zijn slechts als voorbeeld verschaft. Zij zijn berekend op basis van een bodem met een toegestane druk van 1,0 bar (1,0 kg/cm²).
E NOTA: Las medidas de Plinto son sólo indicativas, han sido calculadas considerando un terreno con presión admisible de 1,0bar (1,0 kg /cm²)
DK N.B.: Dimensionerne på Plinto er omtrentlige. De er beregnet ud fra et maks. tilladt jordtryk på 1,0 bar (1,0 kg /cm²)
N N.B.: Størrelsen på pilaren gis kun som et eksempel, den er utregnet på grunnlag av et terreng med et tillatt trykk på 1,0 bar (1,0 kg /cm²)
S OBS! Måten som anges för Plinto är endast ungefärliga och har beräknats på en mark med ett tillåtet tryck på 1,0 bar (1,0 kg /cm²)
RUS ПРИМЕЧАНИЕ: Размеры Plinto, приведенные только в качестве примера, были рассчитаны с учетом почвы с допустимым давлением 1,0 бар (1,0 кг/см²)
CN 注意：底座的外形尺寸完全是参考性的并且表面的容许压力1.0 bar (1.0 kg/cm²)要被计算考虑在内。

Proteggere la parte verniciata
Protect the painted part
Protéger la partie peinte
Lackierte Seite schützen
Bescherm het gelakte gedeelte
Proteger la parte barnizada
Afdæk den lakerede del.
Beskytt den lakkerte delen.
Skydda den lackerade delen.
Предохраните покрашенную сторону.
保护上漆部件。

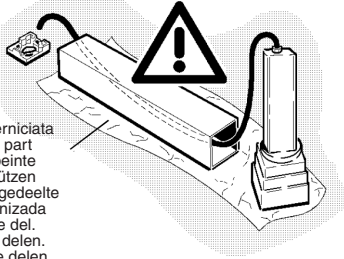

I Per il cablaggio elettrico utilizzare cavi con doppio isolamento.
GB For the electrical wiring use cables with double insulation.
F Pour le câblage électrique, utiliser des câbles à double isolation.
D Für die elektrische Verdrahtung sind Kabel mit Mantel zu verwenden.
NL Gebruik dubbel-geïsoleerde kabels voor de elektrische aansluiting.
E Para el cableado eléctrico servirse de cables con doble aislamiento.
DK De anvendte ledninger skal have dobbelt isolering.
N For elektrisk kabling, bruk kabler med dobbel isolering.
S Använd elkablar med dubbel isolering för kabeldragningen.
RUS Для монтажа кабелепроводки используйте провода с двойной изоляцией.
CN 针对架线，使用双重绝缘的电缆。

I In caso di danneggiamento del cavo flessibile esterno, questo deve essere sostituito dal costruttore, o dal suo servizio di assistenza, o da personale qualificato equivalente, al fine di evitare pericoli.
GB Should the outer flexible cable be somehow damaged, the latter should be replaced by the manufacturer, or by the corresponding service centre, or by an appropriate and qualified member of staff in order to avoid all risk of danger.
F Si le câble flexible extérieur est abîmé, faites-le remplacer par le fabricant, par son service après-vente ou par un professionnel du secteur agréé afin d'éviter tout danger.
D Sollte das äußere Kabel beschädigt sein, so muss es aus Sicherheitsgründen vom Hersteller, dessen Kundendienst oder von dazu autorisiertem Personal ausgewechselt werden.
NL Mocht de externe flexibele slang beschadigd worden, dan moet deze worden vervangen door de fabrikant of door een bevoegde installateur, zodat eventueel gevaar vermeden wordt.
E En caso de daños el cable flexible externo debe substituirse por el fabricante, su servicio de asistencia o personal calificado equivalente para evitar peligros.
DK Hvis den yderste ledning beskadiges, skal den udskiftes af producenten eller er et autoriseret N teknisk servicecenter, eller af kvalificerede fagfolk, så man undgår farlige situationer.
S Hvis ytre fleksible kabel skulle bli skadet, skal denne skiftes ut av produsenten eller tilsvarende servicesenter eller av en egnet og kvalifisert fagperson for å unngå farensisiko.
Om den ytre kabeln skadas ska den bytas ut av tillverkaren, av dess auktoriserade verkstad eller av likvärdig kvalificerad personal för att undvika alla typer av risker.
RUS В случае повреждения внешнего гибкого кабеля во избежание риска поручите его замену производителю, уполномоченному сервису или квалифицированному электрику.
如果外部软缆损坏，须由生产商、对应服务中心或能胜任和资深员工更换新的电缆，以避免任何可能的危险。
CN 针对架线，使用双重绝缘的电缆。

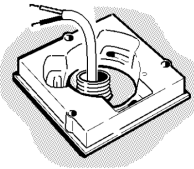

CABLAGGIO PASSANTE
FEEDTHROUGH WIRING
CABLAGE TRAVERSANT
DURCHGANGSKABEL
KABELDOORGANG
CABLEADO PASANTE
GENNEMGÅENDE LEDNINGER
FÖRINGSKABLING
KABELGENOMFÖRING
СКВОЗНОЙ МОНТАЖ
连接线架

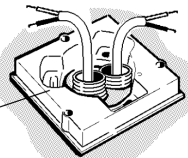

I N.B.: Per il collegamento elettrico alla rete, servirsi dell'art. BZG8 - BZH0 o di altri dispositivi di connessione in classe II che garantiscono il grado di protezione IP66.
GB N.B.: For connection to the mains electricity supply, use item BZG8 - BZH0 or other Class II connection devices which offer the IP66 degree of protection.
F N.B.: Pour le raccordement électrique au secteur, utiliser l'art. BZG8 - BZH0 ou tout autre dispositif de connexion en classe II assurant un indice de protection IP66.
D N.B.: Für den elektrischen Anschluss verwenden Sie die Art. BZG8 - BZH0 oder andre Anschlussvorrichtungen der Klasse II, die den Schutzgrad IP66 gewährleisten.
NL N.B.: Voor de aansluiting op het elektrische net moet u gebruik maken van het art. BZG8 - BZH0 of van andere verbindingsapparaten van klasse II, die een beschermingsgraad IP66 garanderen.
E N.B.: Para la conexión eléctrica a la red, consultar el Art. BZG8 - BZH0 o emplear otros dispositivos de conexión en la clase II que garantizan el grado de protección IP66.
DK N.B.: For elektrisk tilslutning til forsyningsnettet skal man bruge art. BZG8 - BZH0 eller en anden forbindelsesanordning i klasse II, der garanterer en beskyttelsesgrad lig med IP66.
N N.B.: For elektrisk kobling til nettet, bruk art. BZG8 - BZH0 eller andre koblingsanordninger i klasse II som sikrer vernegrad IP66.
S OBS! För anslutningen till elnätet, använd art. BZG8 - BZH0 eller andra anslutningsanordningar i klass II som garanterar skyddsgrad IP66.
RUS ПРИМЕЧАНИЕ: Для подключения к электрической сети используйте артикуль BZG8 - BZH0 или другие соединительные устройства класса II, обеспечивающие класс электробезопасности IP66.
CN 注意事项:对于电子网络连接，需要BZG8 - BZH0产品或者其他的可以保证IP66的保护等级的二级连接设备。

art. B461 - B462 - B463 - B468 - B469
B473 - B474 - B476 - B477 - B479 - B481
B482 - B483 - B488 - B489 - B633 - B634
B635 - B639 - B641 - B642 - B643 - B647
BG19 - BG20 - BG21 - BG22

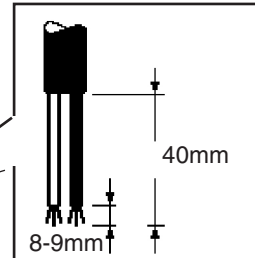
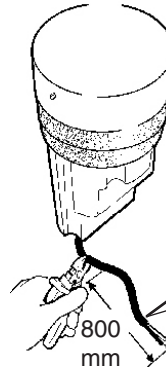

ART.

N° Prodotti collegabili / Sezione cavo
No. of products that can be connected / Cable cross section.
Nombre de Produits reliables / Section câble
Anzahl der Strahler, die miteinander verbunden werden können / Kabeldurchschnitt
N° Verbindbare producten/Doorsnee kabel
N° de productos a conectar/Sección del cable
Antal produkter der kan tilsluttes / Kabelsnitt
Antal produkter som kan tilkoples / kabeltværsnitt
Antal produkter som kan anslutas/kabeltvärsnitt
Кол-во подключаемых приборов / Сечение провода
可连接的产品编号/电缆横截面

ART.	N° Prodotti collegabili / Sezione cavo No. of products that can be connected / Cable cross section.		
	1,5 mm ²	2,5 mm ²	4 mm ²
B466 - B486 - B638 - B646	25	37	45
B461 - B462 - B464 - B465 B481 - B482 - B484 - B485 B633 - B634 - B636 - B637 B641 - B642 - B644 - B645	50	75	97
B463 - B467 - B468 - B472 B483 - B487 - B488 - B492 B635 - B639 - B640 - B643 B647 - B648 - BG23 - BG24 BG25 - BG26 - BG27 - BG28 BG29 - BG30 - MR81 - MR82 MR83 - MR84 - MR85 MR86 - MR87 - MR88 BW60 - BW61 - BW62 BW63 - BW64 - BW65 BW74 - BW75 - BW76 BW77 - BW78 - BW79 BW66 - BW67 - BW68 BW69 - BW70 - BW71 BW80 - BW81 - BW82 BW83 - BW84 - BW85	97	134	173
B469 - B489 - BG19 BG20 - BG21 - BG22	120	160	200
B473 - B475 - B476 - B478	45	60	80
B474 - B477	107	147	190
B479 - B480	148	203	266

ART.	art. B511	art. B512	art. BZG8	art. BZH0
B461 - B462 - B463 - B464 - B465 B466 - B467 - B473 - B474 - B475 B476 - B477 - B478 - B481 - B482 B483 - B484 - B485 - B486 - B487 B633 - B634 - B635 - B636 - B637 B638 - B641 - B642 - B643 - B644 B645 - B646 - MR81 - MR82 - MR83 MR84 - MR85 - MR86 - MR87 - MR88 BW62 - BW63 - BW64 - BW65 - BW68 BW69 - BW70 - BW71 - BW76 - BW77 BW78 - BW79 - BW81 - BW82 - BW83 BW84 - BW85	●			
B468 - B469 - B472 - B479 - B480 B488 - B489 - B492 - B639 - B640 B647 - B648 - BG19 - BG20 - BG21 - BG22		●		
BG23 - BG24 - BG25 - BG26 - BG27 BG28 - BG29 - BG30 - BW60 - BW61 BW66 - BW67 - BW74 - BW75 - BW80 BW81			●	●

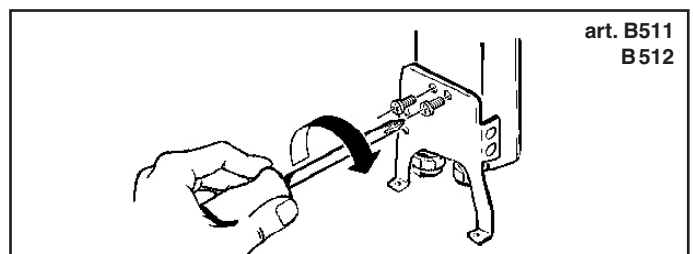

art. B511
B512

CABLAGGIO ELETTRICO CON L'ART. B511
 ELECTRICAL WIRING WITH ART. B511
 CÂBLAGE ÉLECTRIQUE AVEC L'ART. B511
 VORSCHALTGERÄT: ART. B511
 ELEKTRISCHE BEKABELING MET ART. B511
 CABLEADO ELÉCTRICO CON ART. B511
 ELEKTRISK LEDNINGSFØRING MED ART. B511
 ELEKTRISK KOPLING MED ART. B511
 ELKABLAR MED ART. B511
 МОНТАЖ КАБЕЛЬНОЙ ПРОВОДКИ ДЛЯ АРТИКЛЯ B511
 ART. B511 带电线

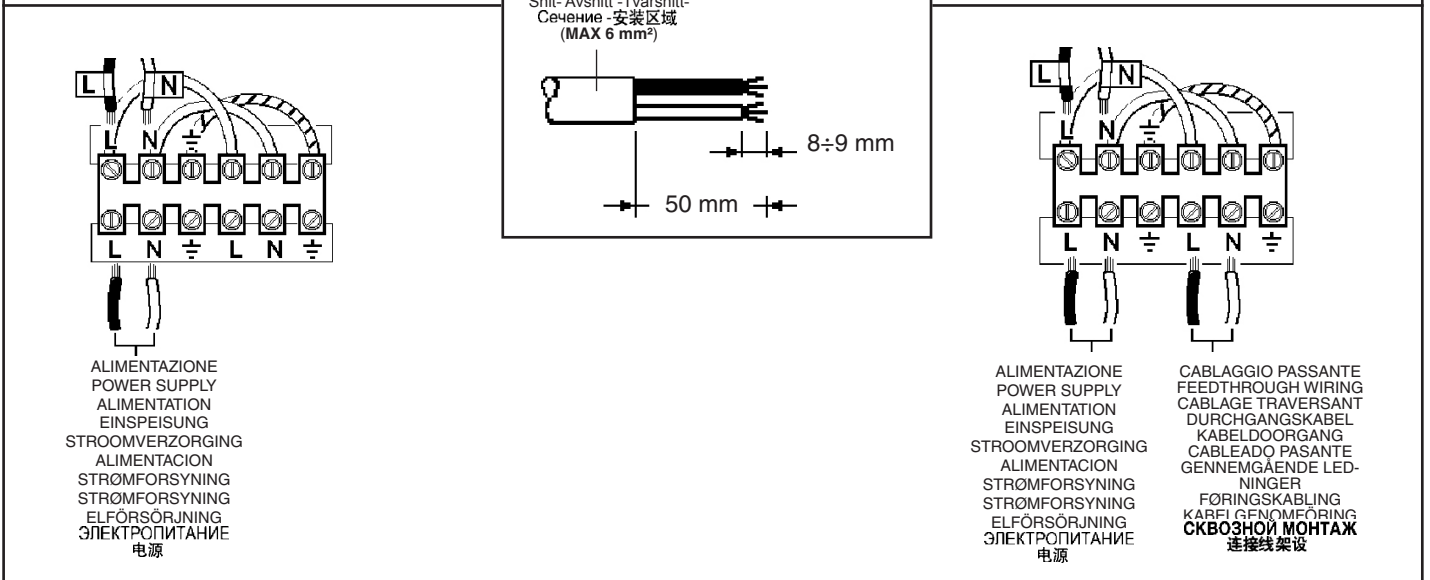
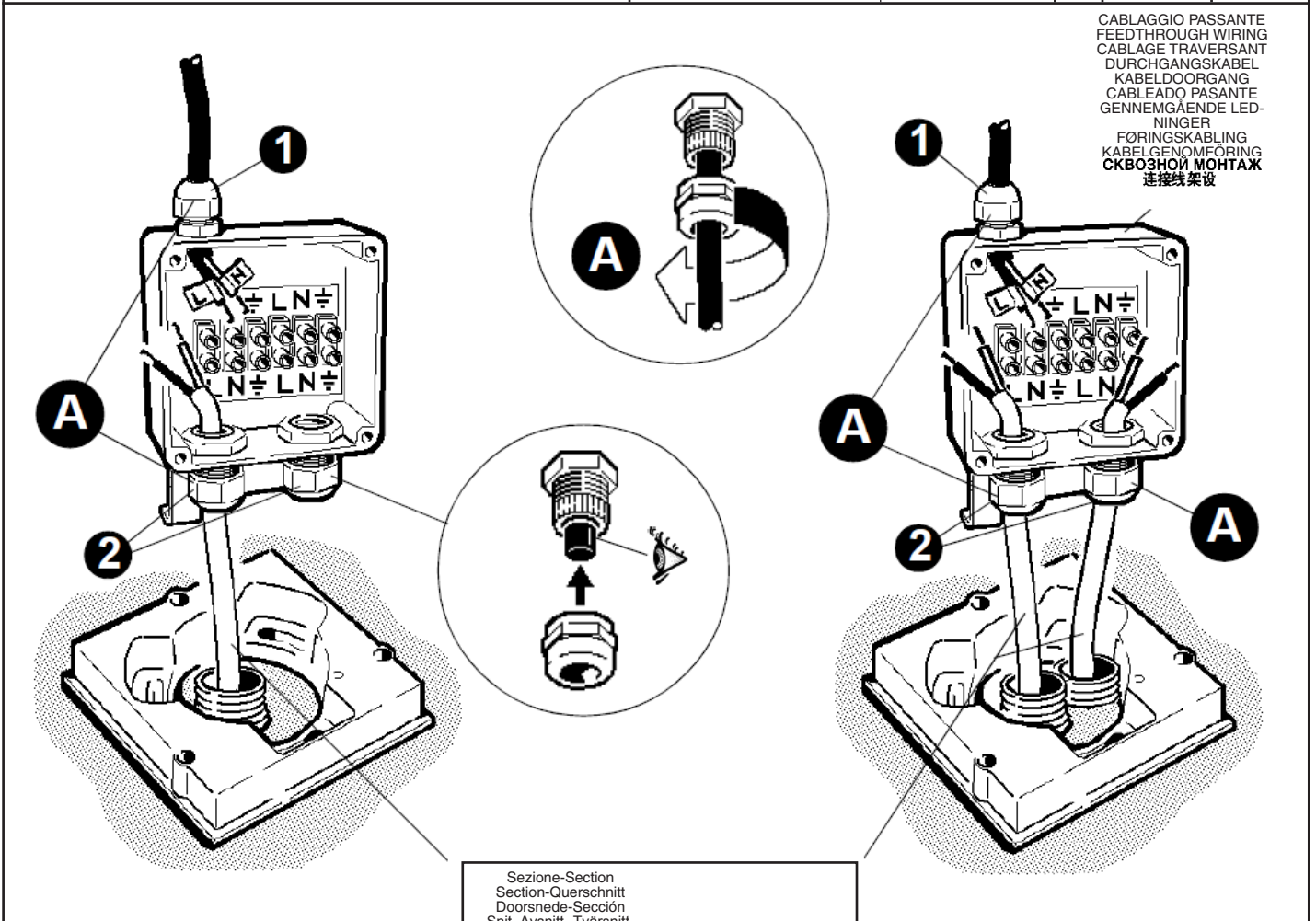
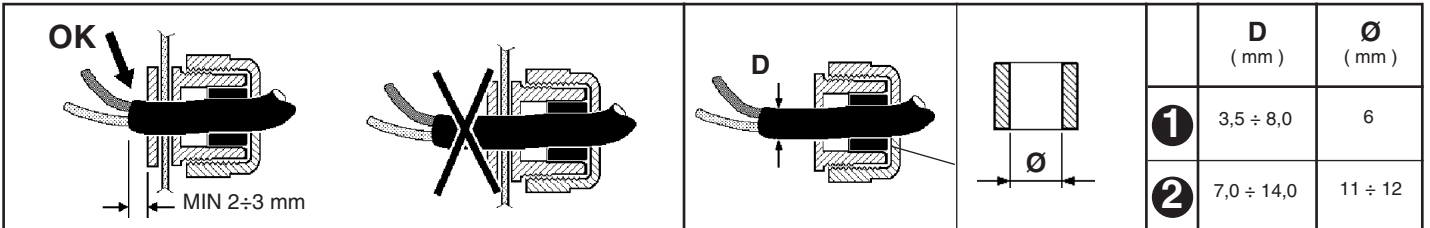

CABLAGGIO ELETTRICO CON L'ART. B512
 ELECTRICAL WIRING WITH ART. B512
 CÂBLAGE ÉLECTRIQUE AVEC L'ART. B512
 VORSCHALTGERÄT: ART. B512
 ELEKTRISCHE BEKABELING MET ART. B512
 CABLEADO ELÉCTRICO CON ART. B512
 ELEKTRISK LEDNINGSFØRING MED ART. B512
 ELEKTRISK KOPLING MED ART. B512
 ELKABLAR MED ART. B512
 МОНТАЖ КАБЕЛЬНОЙ ПРОВОДКИ ДЛЯ АРТИКЛЯ В512
 ART. B512带电线

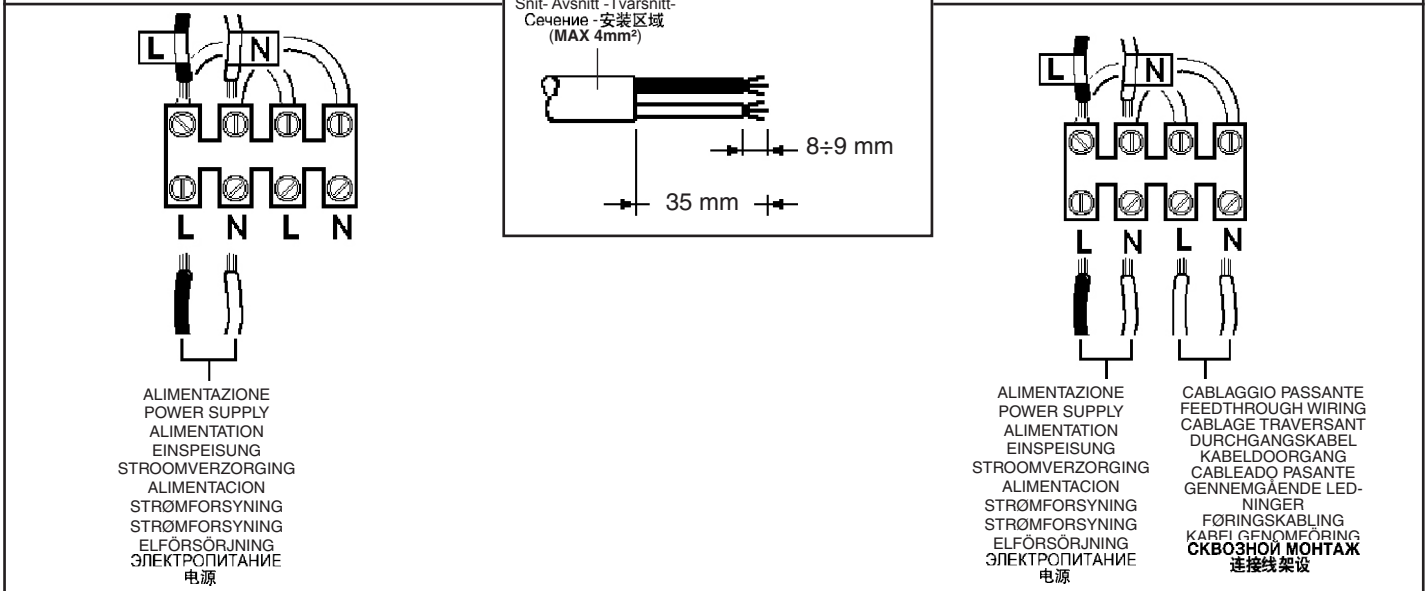
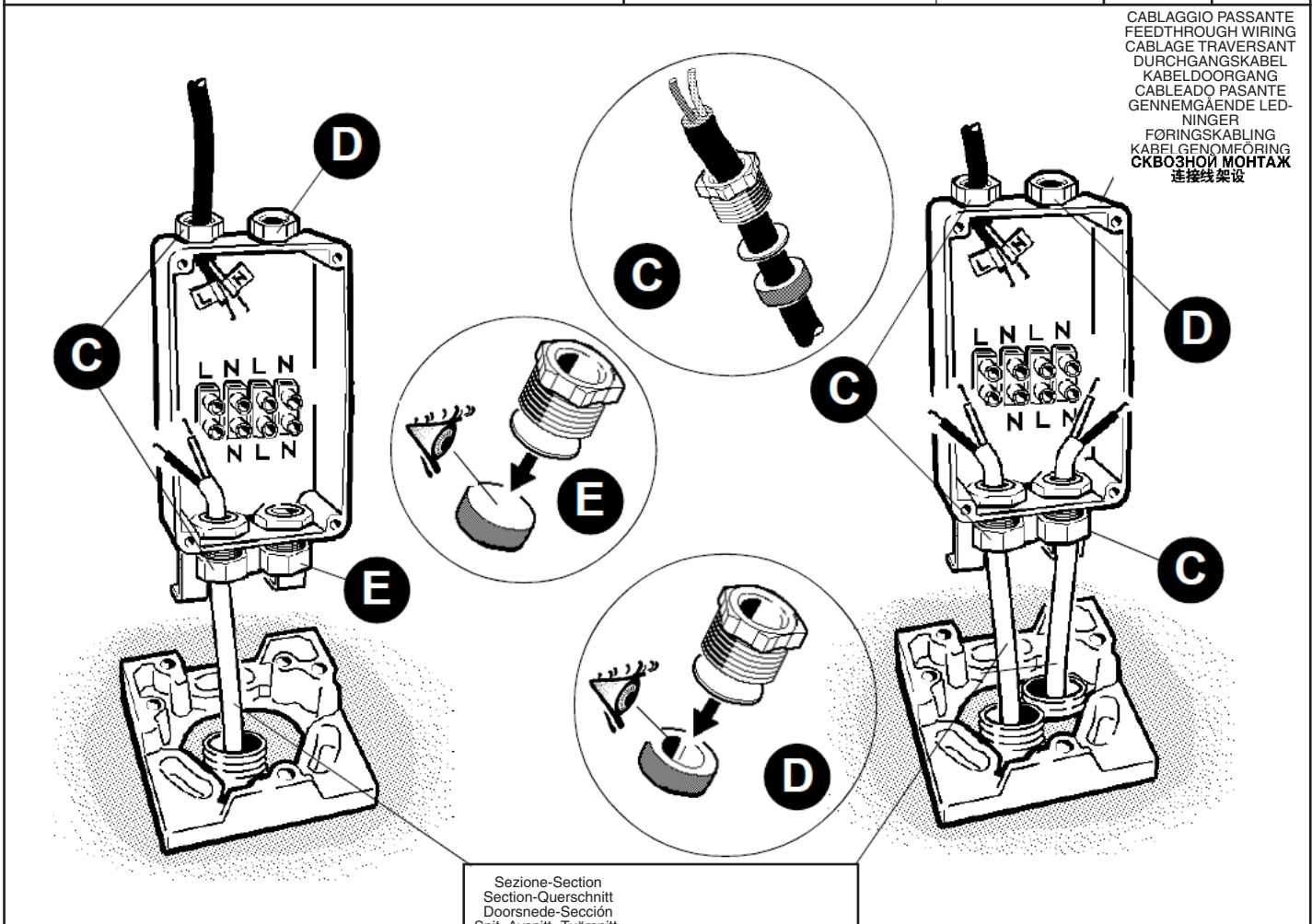
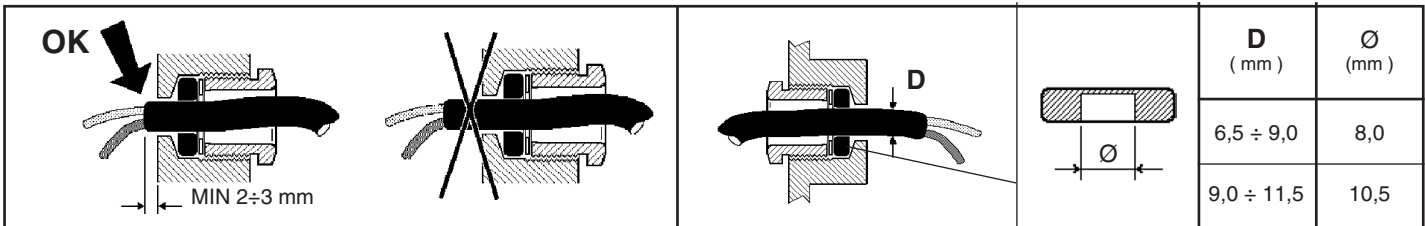

art. B511
B512

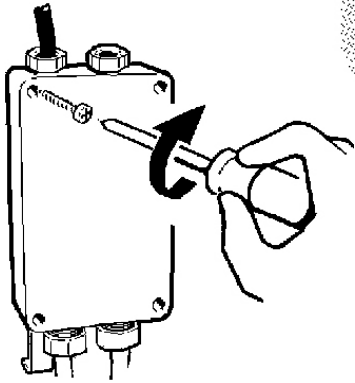
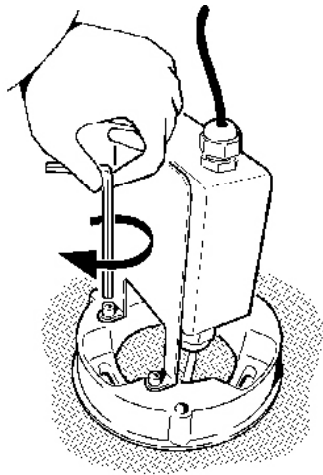

art. BG23 - BG24 - BG25 - BG26 - BG27 - BG28
BG29 - BG30 - BW60 - BW61 - BW66
BW67 - BW74 - BW75 - BW80
BW81

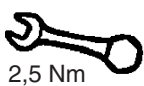
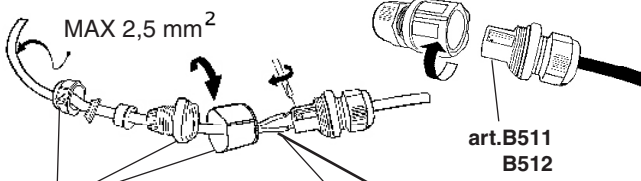

2,5 Nm

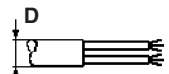
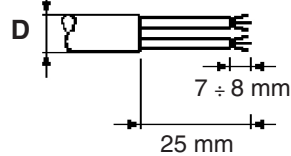
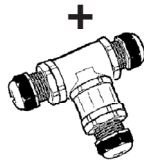

D (mm)

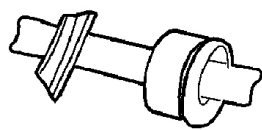

6,5 ÷ 8 mm

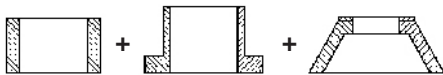

8 ÷ 9 mm

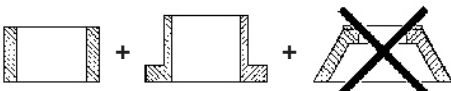

9 ÷ 13 mm

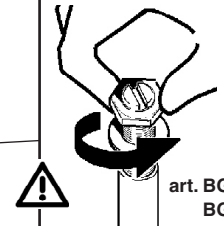
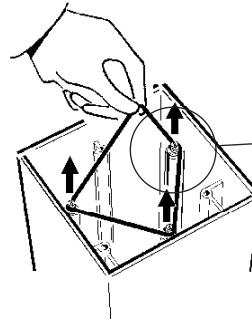
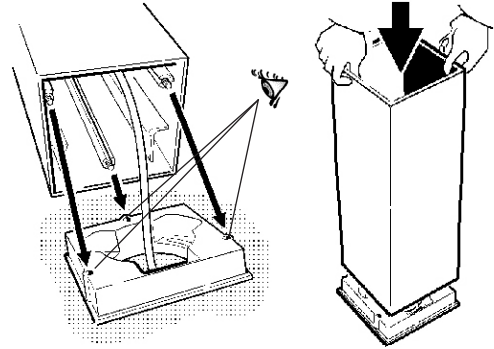

art. BG25 - BG28
BG29 - BG30



I Prima di utilizzare il prodotto asportare gli elastici.

GB Remove the elastic bands before using the product.

F Enlevez les élastiques avant d'utiliser le produit.

D Bevor Sie das Produkt verwenden, entfernen Sie die Gummis.

NL Voordat u het product gaat gebruiken moeten de elastieken verwijderd worden.

E Remover los elásticos antes de utilizar el producto.

DK Fjern elastikbåndene inden produktet tages i brug.

N Fjern de elastiske båndene før bruk av produktet.

S Ta bort gummisnoddarna innan utrustningen används.

RUS Перед началом эксплуатации прибора снимите с него резинки.

CN 在使用产品之前先取下弹性木梢。

Serrare a fondo
Tighten firmly
Serrer à fond
Fest einrasten
Goed aanschroeven
Enrosar en firme
Stram godt til
Skrues i bund
Dra åt till botten
Закрутить до упора
牢牢拧紧

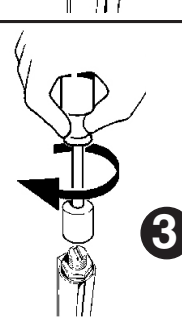
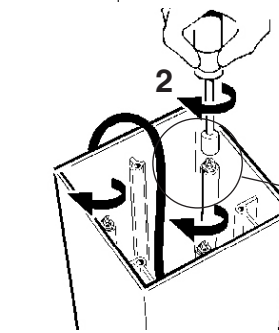
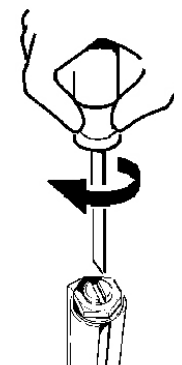
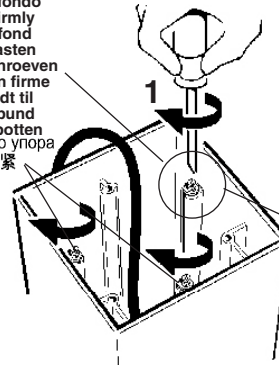

ART.

3

B461 - B462 - B463 - B464 - B465 - B466 - B467 - B473
B474 - B475 - B476 - B477 - B478 - B481 - B482 - B483
B484 - B485 - B486 - B487 - B633 - B634 - B635 - B636
B637 - B638 - B641 - B642 - B643 - B644 - B645 - B646
BG23 - BG24 - BG25 - BG26 - BG27 - BG28 - BG29 - BG30
MR81 - MR82 - MR83 - MR84 - MR85 - MR86 - MR87
MR88 - BW60 - BW61 - BW62 - BW63 - BW64 - BW65
BW74 - BW75 - BW76 - BW77 - BW78 - BW79 - BW66
BW67 - BW68 - BW69 - BW70 - BW71 - BW80 - BW81
BW82 - BW83 - BW84 - BW85

MAX 10 Nm

B468 - B469 - B472 - B479 - B480 - B488 - B489
B492 - B639 - B640 - B647 - B648 - BG19 - BG20 - BG21
BG22

MAX 5 Nm

LATO PEDONALE O CARRABILE
 PEDESTRIAN OR VEHICULAR SIDE
 CÔTÉ PIÉTONS OU VOITURES
 FUSSGÄNGER- ODER FAHRWEGSEITE
 VOETGANGERSZIJDE OF BERIJDBARE ZIJDE
 LADO PEATONAL O VEHICULAR
 GANGSTI ELLER KØREBANE
 FOTGJENGER- ELLER KJØRETØYSIDE
 SIDA FØR FOTGÅNGARE ELLER FORDON
 ПЕШЕХОДНАЯ ИЛИ ПРОЕЗЖАЯ СТОРОНА
 行人或机动车侧

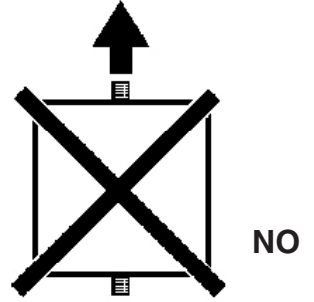
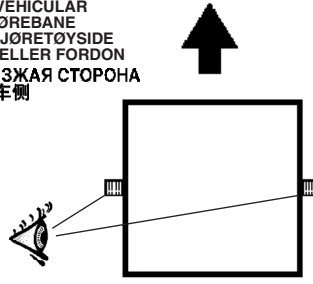
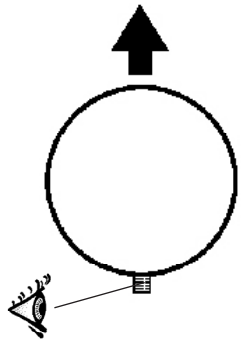

LATO PEDONALE O CARRABILE
 PEDESTRIAN OR VEHICULAR SIDE
 CÔTÉ PIÉTONS OU VOITURES
 FUSSGÄNGER- ODER FAHRWEGSEITE
 VOETGANGERSZIJDE OF BERIJDBARE
 ZIJDE
 LADO PEATONAL O VEHICULAR
 GANGSTI ELLER KØREBANE
 FOTGJENGER- ELLER KJØRETØYSIDE
 SIDA FØR FOTGÅNGARE ELLER FORDON
 ПЕШЕХОДНАЯ ИЛИ ПРОЕЗЖАЯ СТОРОНА
 行人或机动车侧

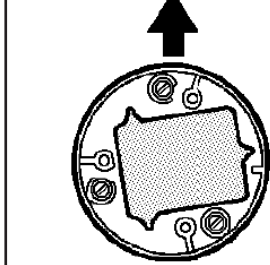
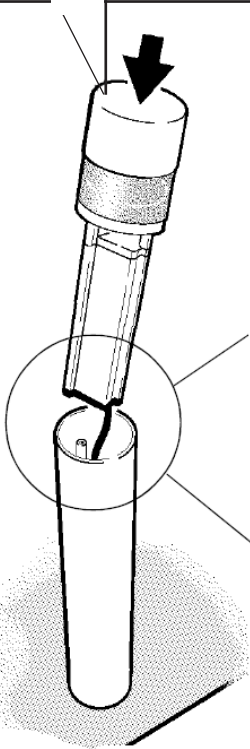

art. B468 - B469
 B472 - B479
 B480 - B639
 B640
 BG19 - BG20

LATO PEDONALE O CARRABILE
 PEDESTRIAN OR VEHICULAR SIDE
 CÔTÉ PIÉTONS OU VOITURES
 FUSSGÄNGER- ODER FAHRWEGSEITE
 VOETGANGERSZIJDE OF BERIJDBARE
 ZIJDE
 LADO PEATONAL O VEHICULAR
 GANGSTI ELLER KØREBANE
 FOTGJENGER- ELLER KJØRETØYSIDE
 SIDA FØR FOTGÅNGARE ELLER FORDON
 ПЕШЕХОДНАЯ ИЛИ ПРОЕЗЖАЯ СТОРОНА
 行人或机动车侧

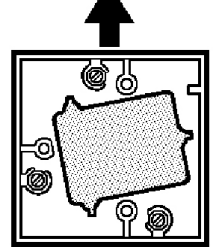
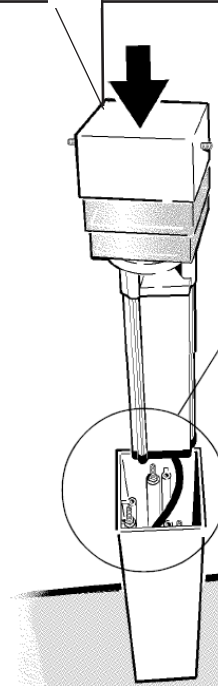

art. B488 - B489
 B492 - B647
 B648 - BG21
 BG22



LATO PEDONALE O CARRABILE
 PEDESTRIAN OR VEHICULAR SIDE
 CÔTÉ PIÉTONS OU VOITURES
 FUSSGÄNGER- ODER FAHRWEGSEITE
 VOETGANGERSZIJDE OF BERIJDBARE ZIJDE
 LADO PEATONAL O VEHICULAR
 GANGSTI ELLER KØREBANE
 FOTGJENGER- ELLER KJØRETØYSIDE
 SIDA FØR FOTGÅNGARE ELLER FORDON
 ПЕШЕХОДНАЯ ИЛИ ПРОЕЗЖАЯ СТОРОНА
 行人或机动车侧

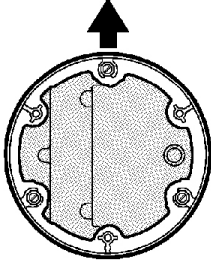

art. B461 - B462 - B463
 B464 - B465 - B466
 B467 - B473 - B474
 B475 - B476 - B477
 B478 - B633 - B634
 B635 - B636 - B637
 B638 - BG23 - BG24
 BG25 - BG29 - MR81
 MR82 - MR83 - MR84
 BW60 - BW61 - BW62
 BW63 - BW64 - BW65
 BW74 - BW75 - BW76
 BW77 - BW78 - BW79

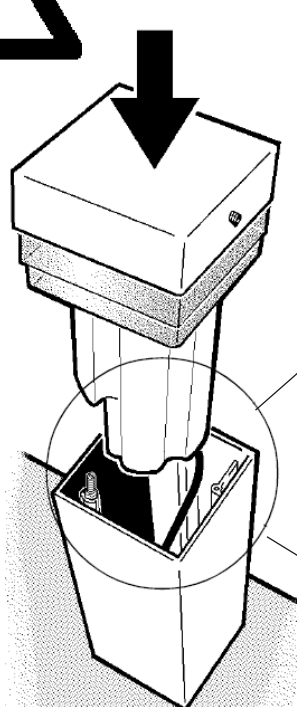
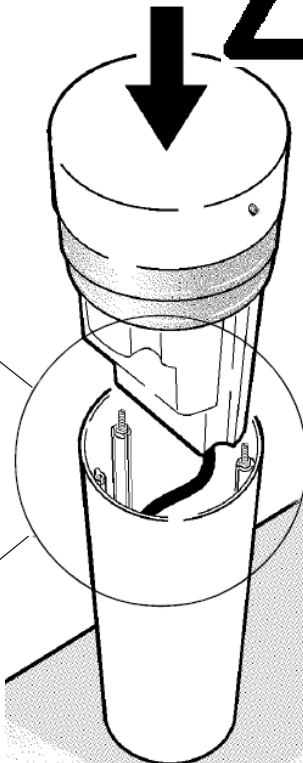

LATO PEDONALE O CARRABILE
 PEDESTRIAN OR VEHICULAR SIDE
 CÔTÉ PIÉTONS OU VOITURES
 FUSSGÄNGER- ODER FAHRWEGSEITE
 VOETGANGERSZIJDE OF BERIJDBARE ZIJDE
 LADO PEATONAL O VEHICULAR
 GANGSTI ELLER KØREBANE
 FOTGJENGER- ELLER KJØRETØYSIDE
 SIDA FØR FOTGÅNGARE ELLER FORDON
 ПЕШЕХОДНАЯ ИЛИ ПРОЕЗЖАЯ СТОРОНА
 行人或机动车侧

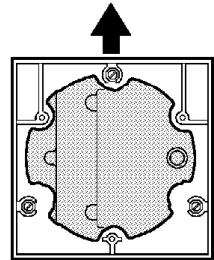

art. B481 - B482 - B483
 B484 - B485 - B486
 B487 - B641 - B642
 B643 - B644 - B645
 B646 - BG26 - BG27
 BG28 - BG30 - MR85
 MR86 - MR87 - MR88
 BW66 - BW67 - BW68
 BW69 - BW70 - BW71
 BW80 - BW81 - BW82
 BW83 - BW84 - BW85

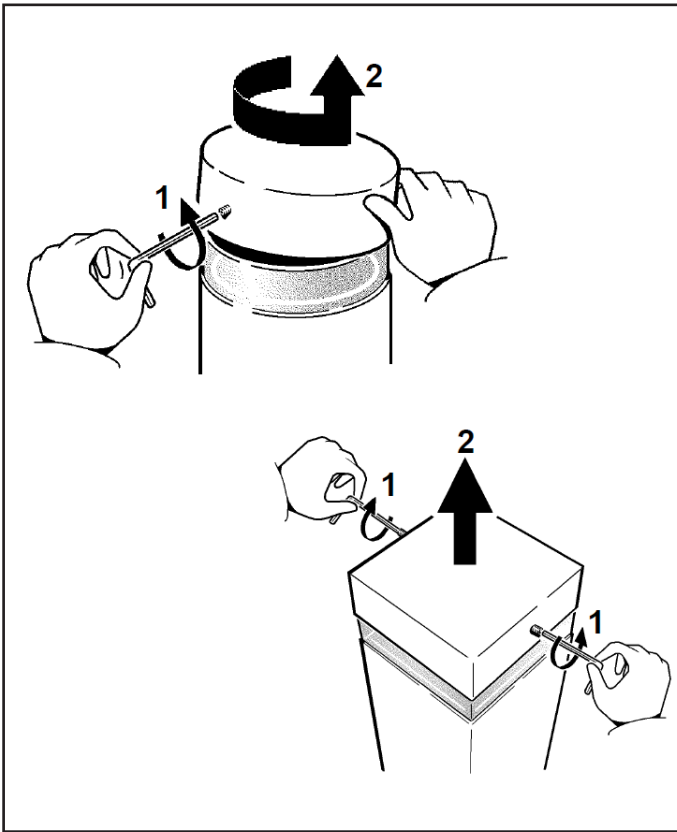

LED VERSION

art. BG23 - BG24 - BG26 - BG27 - MR81 - MR82 - MR83
 MR84 - MR85 - MR86 - MR87 - MR88 - BW60 - BW61
 BW62 - BW63 - BW64 - BW65 - BW74 - BW75 - BW76
 BW77 - BW78 - BW79 - BW66 - BW67 - BW68 - BW69
 BW70 - BW71 - BW80 - BW81 - BW82 - BW83 - BW84
 BW85 - B469 - B489 - BG19 - BG20 - BG21 - BG22

I Evitare qualsiasi contatto diretto con il riflettore.

GB Avoid direct contact with reflector.

F Évitez tout contact direct avec le réflecteur.

D Jeglichen direkten Kontakt mit dem Reflektor vermeiden.

NL Vermijd elk direct contact met de reflector.

E Evitar cualquier contacto directo con el reflector.

DK Undgå enhver direkte kontakt med reflektoren.

N Unngå direkte kontakt med reflektor.

S Undvik all typ av direktkontakt med reflektorn.

RUS Избегайте любого прямого касания к отражателю.

CN 请勿与反射器直接接触。

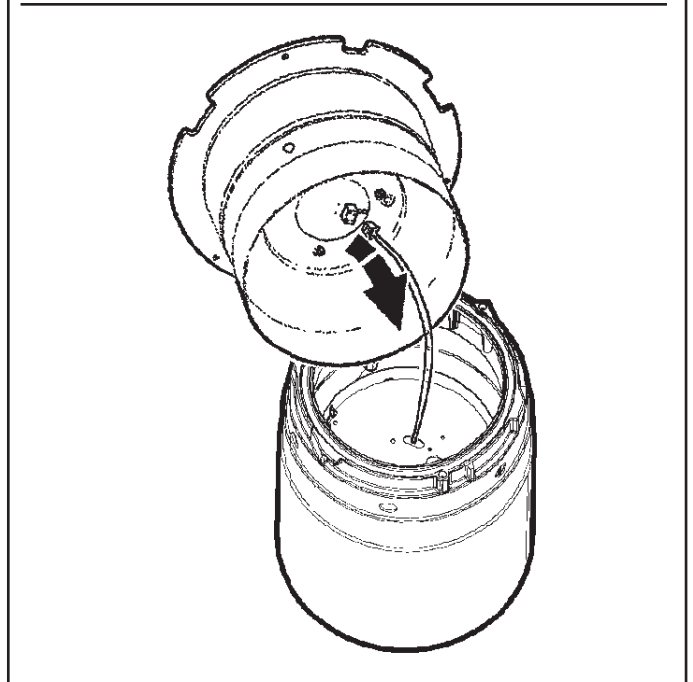
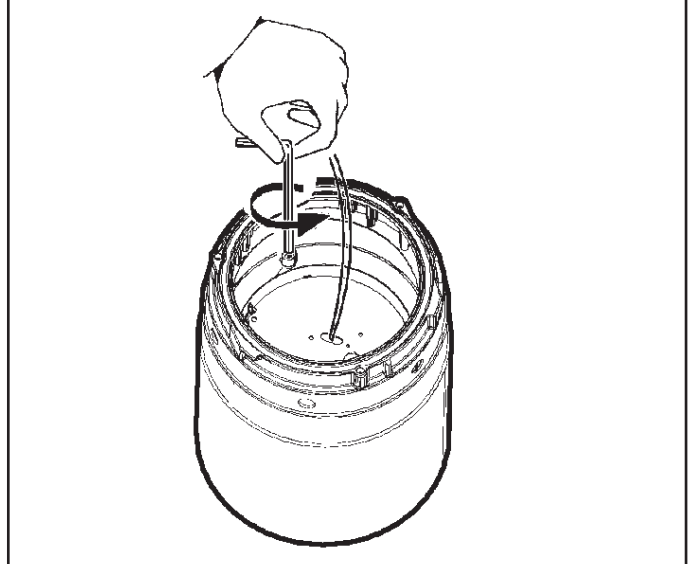
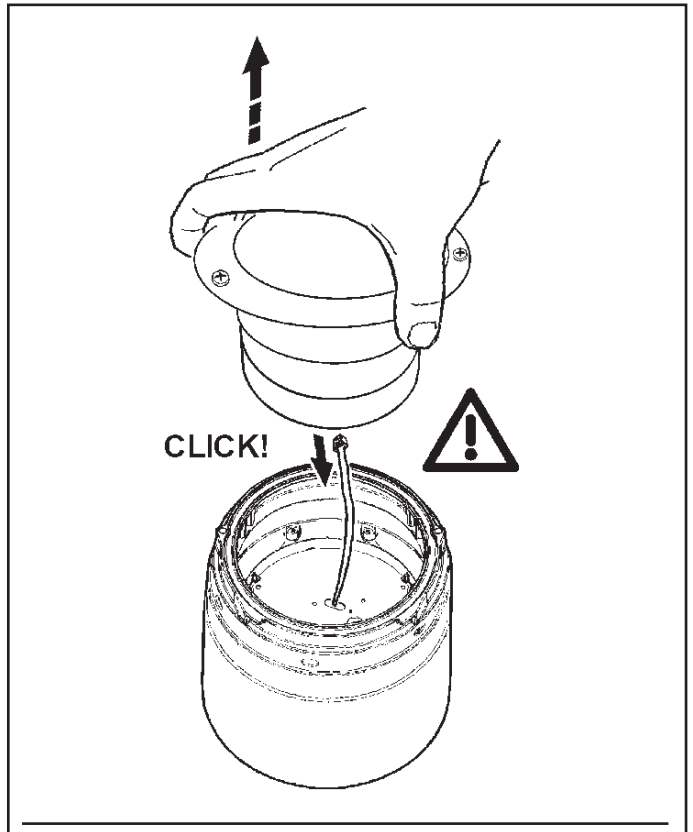
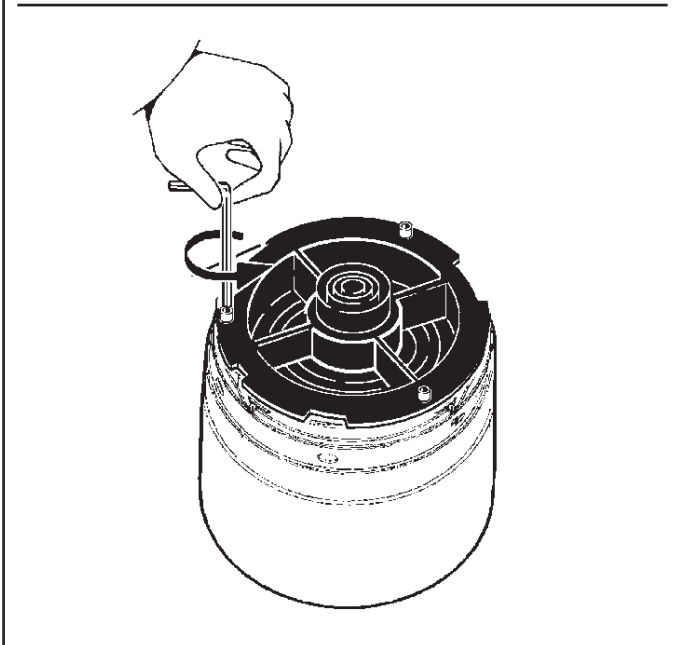

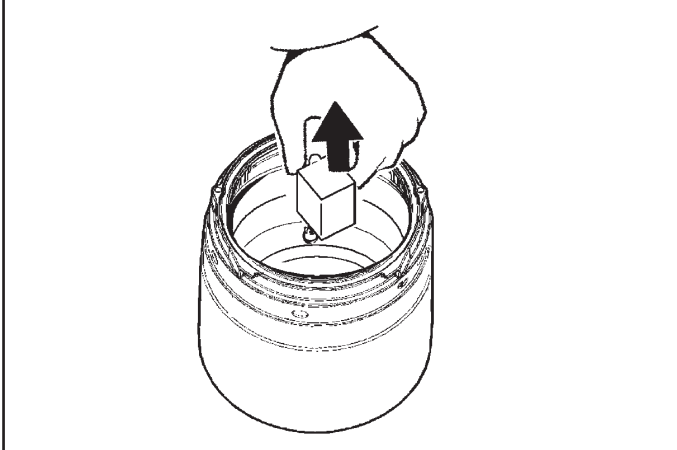
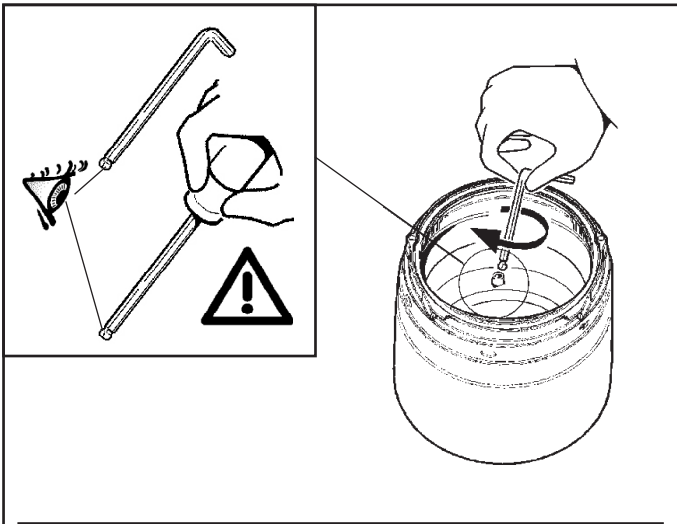

HID VERSION

art. B461 - B462 - B463 - B464 - B465 - B466 - B467 - B473
 B474 - B475 - B476 - B477 - B478 - B481 - B482 - B483
 B484 - B485 - B486 - B487 - B633 - B634 - B635 - B636
 B637 - B638 - B641 - B642 - B643 - B644 - B645 - B646
 BG25 - BG28 - BG29 - BG30 - B468 - B472 - B479
 B480 - B488 - B492 - B639 - B640 - B647 - B648

- I Evitare qualsiasi contatto diretto con il riflettore.
- GB Avoid direct contact with reflector.
- F Évitez tout contact direct avec le réflecteur.
- D Jeglichen direkten Kontakt mit dem Reflektor vermeiden.
- NL Vermijd elk direct contact met de reflector.
- E Evitar cualquier contacto directo con el reflector.
- DK Undgå enhver direkte kontakt med reflektoren.
- N Unngå direkte kontakt med reflektor.
- S Undvik all typ av direktkontakt med reflektorn.
- RUS Избегайте любого прямого касания к отражателю.
- CN 请勿与反射器直接接触。

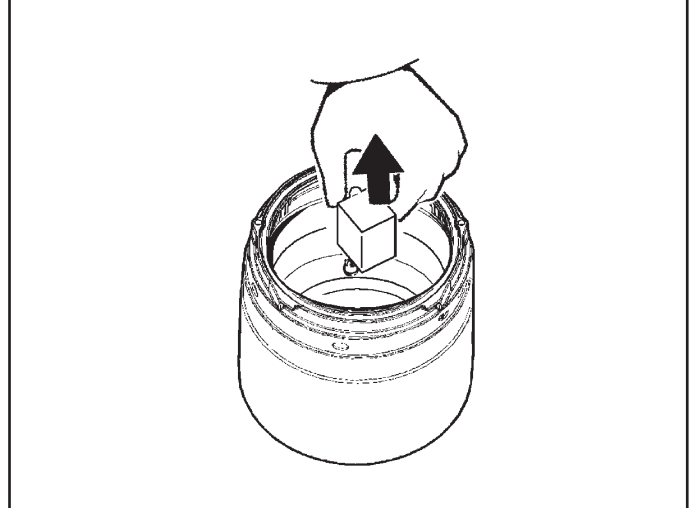
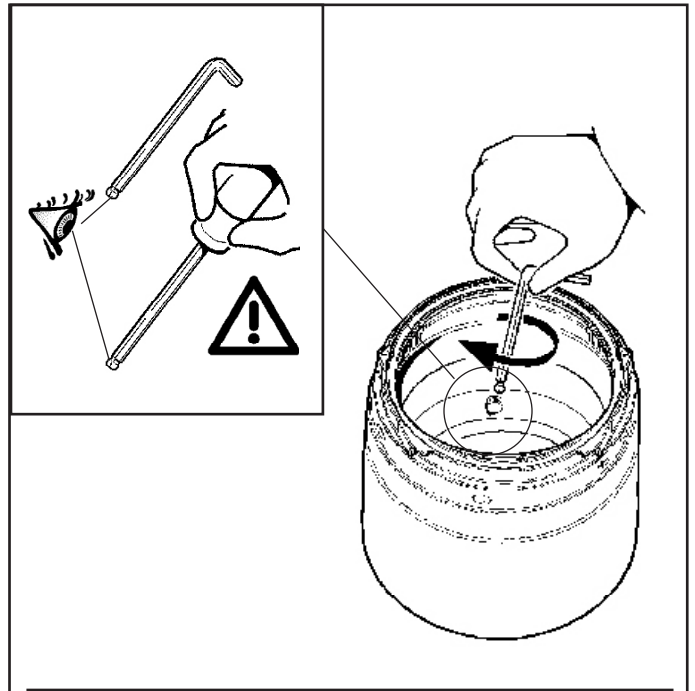
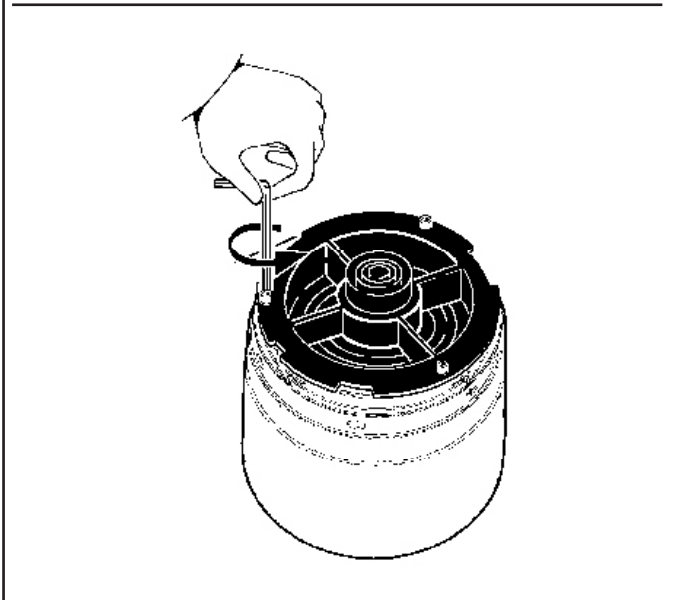

art. B473
 B474
 B475

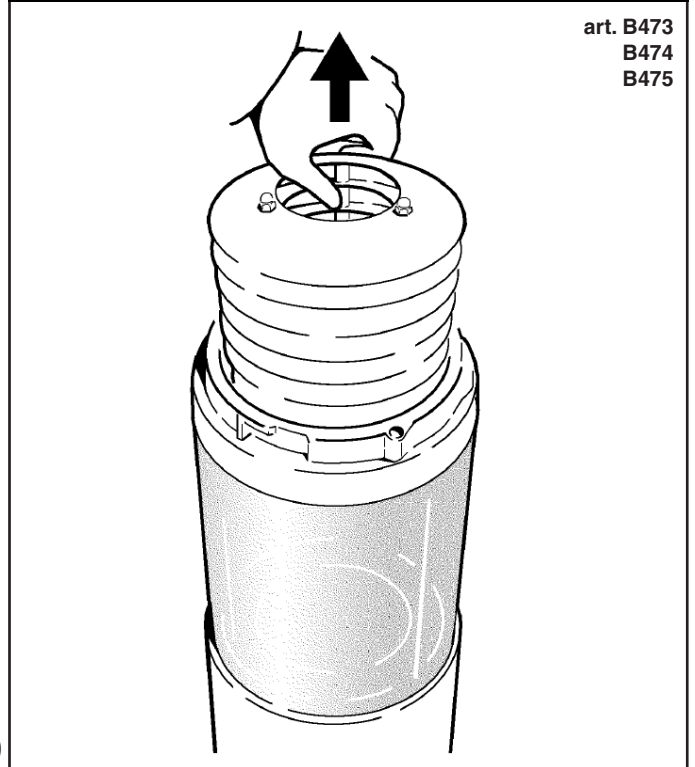

art. B461 - B462 - B464 - B465 - B466 - B481 - B482 - B484
 B485 - B486 - B633 - B634 - B636 - B637 - B638 - B641
 B642 - B644 - B645 - B646

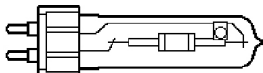

PHILIPS " CDM-T "
 OSRAM " HCI-T "

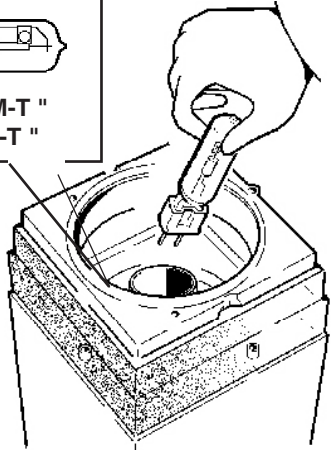

I Le prestazioni fotometriche dichiarate a catalogo sono garantite usando le lampade indicate in figura.
 N.B.: Assicurarsi che la lampada sia inserita nella sede del portalamпада fino in fondo.

GB The photometric performance indicated in the catalogue is guaranteed when using the shown in the figure.
 N.B.: Make sure that the lamp is properly inserted all the way into the lamp holder.

F Les performances photométriques reportées dans notre catalogue ne sont atteintes qu'en montant les lampes indiquées (voir figure).
 N.B.: Assurez-vous que la lampe soit insérée à fond dans la douille.

D Die im Katalog angegebenen photometrischen Leistungen werden bei Einsatz der in der Abbildung veranschaulichten Lampen gewährleistet.
 N.B.: Vergewissern Sie sich bitte, daß die Lampe fest in die Lampenhalterung eingeschraubt ist.

NL De in de catalogus vermelde fotometrische prestaties worden gegarandeerd als de lampen worden gebruikt die in de afbeelding zijn aangegeven.
 N.B.: Controleer dat de lamp goed is aangedraaid in de lamphouder.

E Las prestaciones fotométricas que declara el catálogo se garantizan al utilizar las lámparas indicadas en figura.
 NOTA: Comprobar que la bombilla ha sido enroscada en el portalamparas hasta el tope.

DK Den angivne lysnormale ydelse i kataloget garanteres, hvis man bruger de angivne lyskilder, som vist i figuren.
 N.B.: Kontrollér, at lyskilden sidder korrekt i fatningen og er helt i bund.

N Den fotometriske ytelsen som indikeres i katalogen garanteres ved bruk av viste lamper.
 N.B.: Påse at lampen er riktig innsatt helt inn i lampeholderen.

S Den fotometriske kapaciteten som oppges i katalogen garanteras under förutsättning att lamporna som indikeras i figuren används.
 OBS! Försäkra dig om att lampan är insatt ordentligt i botten i lamphållarens säte.

RUS Светотехнические характеристики, указанные в каталоге, гарантируются в случае применения лампы типа, указанного на рисунке.
 ПРИМЕЧАНИЕ: Проверьте, чтобы лампа была вставлена в гнездо патрона до упора.

CN 仅按图示使用时，才能保证产品目录里显示的配光性能。
 注意：确保光源正确插入灯座。

art. B473
 B474
 B475

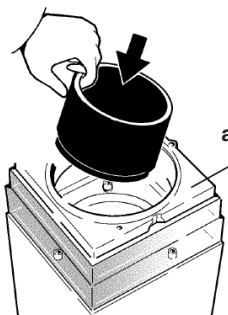
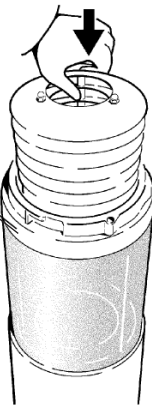

art. B633 - B634 - B635 - B636
 B637 - B638 - B641 - B642
 B643 - B644 - B645 - B646
 BG29 - BG30

art. B481 - B482 - B483 - B484
 B485 - B486 - B487 - B641
 B642 - B642 - B644 - B645
 B646 - BG26 - BG27 - BG28
 BG30 - MR81 - MR82 - MR83
 MR84 - MR85 - MR86 - MR87
 MR88 - BW60 - BW61 - BW62
 BW63 - BW64 - BW65 - BW74
 BW75 - BW76 - BW77 - BW78
 BW79 - BW66 - BW67 - BW68
 BW69 - BW70 - BW71 - BW80
 BW81 - BW82 - BW83 - BW84
 BW85

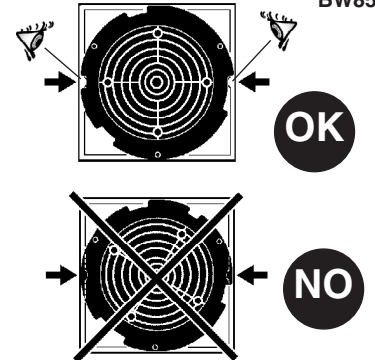
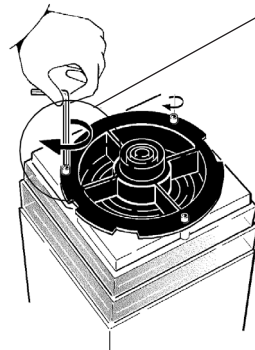

LATO PEDONALE O CARRABILE
 PEDESTRIAN OR VEHICULAR SIDE
 CÔTÉ PIÉTONS OU VOITURES
 FUSSGÄNGER- ODER FAHRWEGSEITE
 VOETGANGERSZIJDE OF BERIJDBARE ZIJDE
 LADO PEATONAL O VEHICULAR
 GANGSTI ELLER KJØREBANE
 FOTGJENGER- ELLER KJØRETØYSIDE
 SIDA FÖR FOTGÄNGARE ELLER FORDON
 ПЕШЕХОДНАЯ ИЛИ ПРОЕЗЖАЯ СТОРОНА
 行人或机动车辆侧

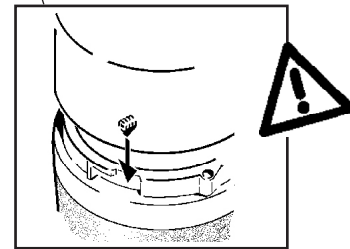
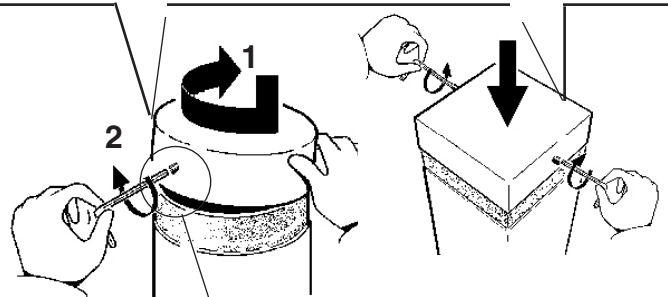
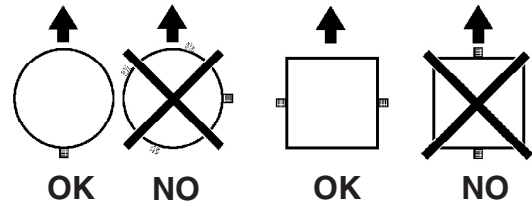

I In caso di rottura delle lenti il prodotto non può essere utilizzato, contattare il costruttore per la sua sostituzione.
 GB Should the lenses break, the product cannot be used. Contact the manufacturer for replacement.
 F En cas de rupture des lentilles, le produit ne peut plus être utilisé. Contacter le fabricant pour procéder à son remplacement.
 D Im Falle einer Beschädigung der Linsen darf das Produkt nicht verwendet werden. Setzen Sie sich bitte mit dem Hersteller in Verbindung, der für den Ersatz sorgen wird.
 NL Indien de lenzen kapot zijn kan het product niet geïnstalleerd worden. Neem contact op met de fabrikant om ze te vervangen.
 E En caso de rotura de las lentes, el producto no puede utilizarse y se debe contactar con el fabricante para su sustitución.
 DK Hvis produktets linser ødelægges, kan det ikke anvendes. Kontakt producenten med henblik på udskiftning.
 N Hvis linsene blir ødelagt kan ikke produktet brukes lenger. Ta kontakt med produsenten for å få det skiftet ut.
 S Produkten kan inte användas vid brott på linser. Kontakta tillverkaren för byte av linser.
 RUS В случае повреждения линз прибор нельзя использовать, обратиться к производителю для его замены.
 CN 如果镜头破裂，请不要使用该产品。请联系制造商进行更换。

+ART. XXXX

ACCESSORIO
ACCESSORY
ACCESSOIRE
ZUBEHÖRTEIL
ACCESSOIRE
ACCESSORIO
Tilbehør
Tilbehør
Tilbehör
Аксессуары
附件



ART.	art. B503	art. B504	art. B505	art. B506	art. B507	art. B508
B461	●		●		●	
B462	●		●		●	
B463	●		●		●	
B464	●		●		●	
B465	●		●		●	
B466	●		●		●	
B467	●		●		●	
B468		●		●		●
B469		●		●		●
BG19		●		●		●
BG20		●		●		●
B472		●		●		●
B481	●		●		●	
B482	●		●		●	
B483	●		●		●	
B484	●		●		●	
B485	●		●		●	
B486	●		●		●	
B487	●		●		●	
B488		●		●		●
B489		●		●		●
BG21		●		●		●
BG22		●		●		●
B492		●		●		●
B633	●		●		●	
B634	●		●		●	
B635	●		●		●	
B636	●		●		●	
B637	●		●		●	
B638	●		●		●	
B639		●		●		●
B640		●		●		●
B641	●		●		●	
B642	●		●		●	
B643 - BG25	●		●		●	
B644 - BG28	●		●		●	
B645 - BG29	●		●		●	
B646 - BG30	●		●		●	
B647		●		●		●
B648		●		●		●

+ART. XXXX

ACCESSORIO
ACCESSORY
ACCESSOIRE
ZUBEHÖRTEIL
ACCESSOIRE
ACCESSORIO
Tilbehør
Tilbehør
Tilbehör
Аксессуары
附件



ART.	art. X023	art. X024	art. X087	art. X088
BG23 - BG24				
MR81 - MR82	●		●	
MR83 - MR84				
BG26 - BG27				
MR85 - MR86		●		●
MR87 - MR88				
BW60 - BW61				
BW62 - BW63				
BW64 - BW65	●		●	
BW74 - BW75				
BW76 - BW77				
BW78 - BW79				
BW66 - BW67				
BW68 - BW69				
BW70 - BW71		●		●
BW80 - BW81				
BW82 - BW83				
BW84 - BW85				

art. B503
B504
MXN7

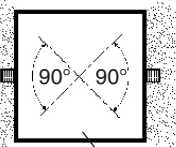
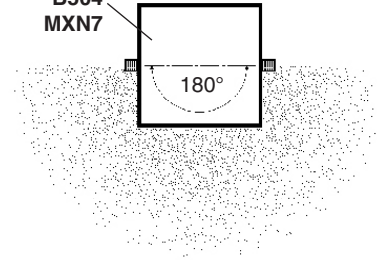

art. B505
B506

art. B507
B508

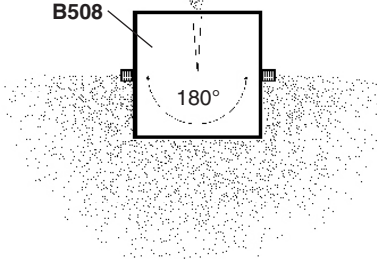

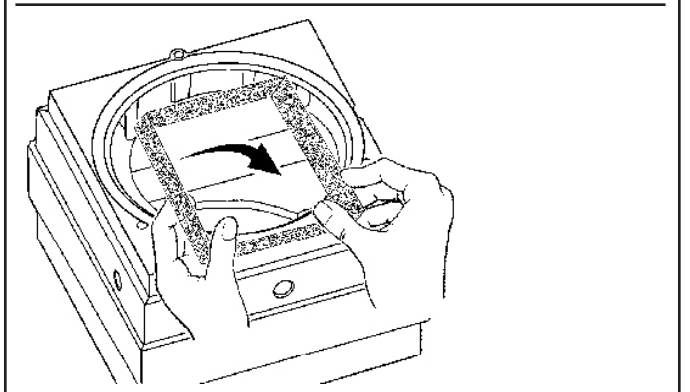
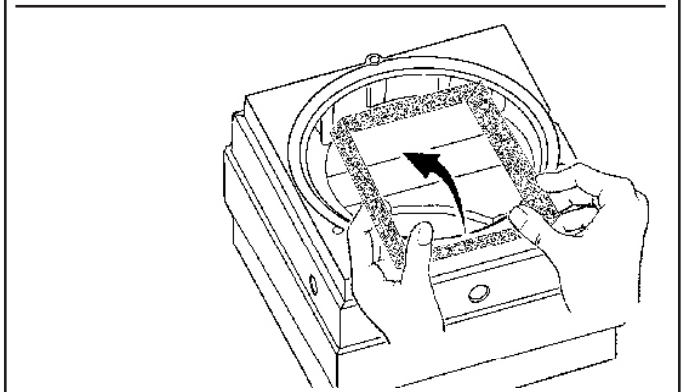
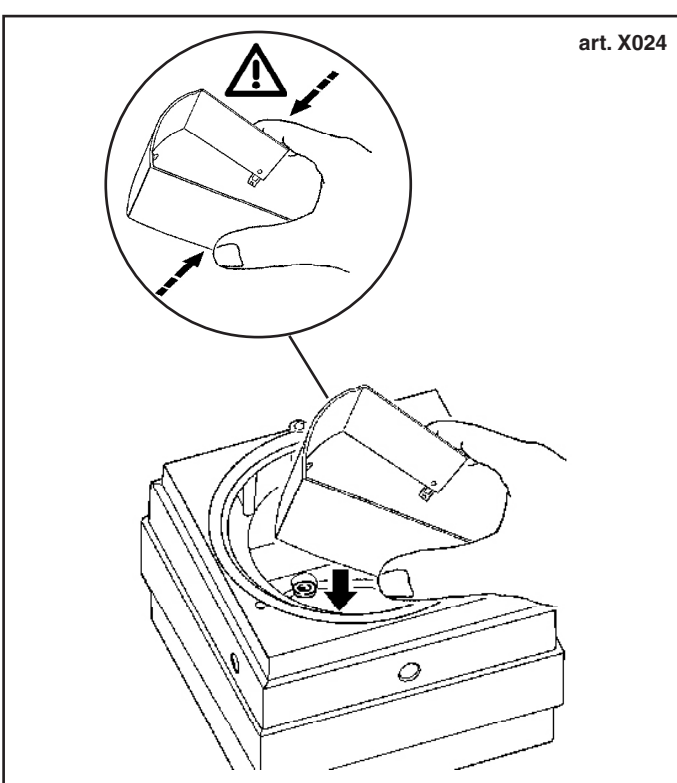
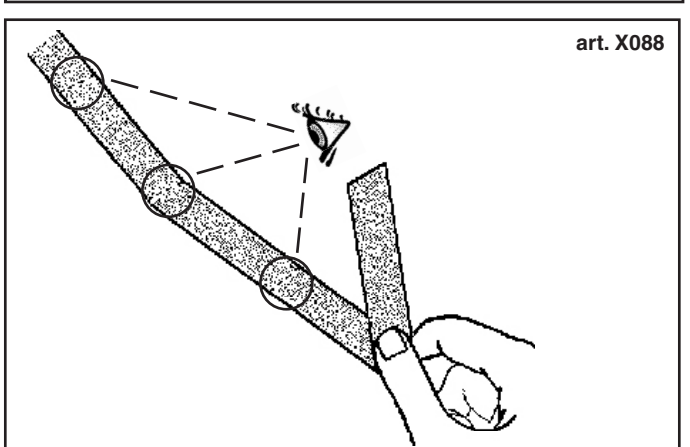
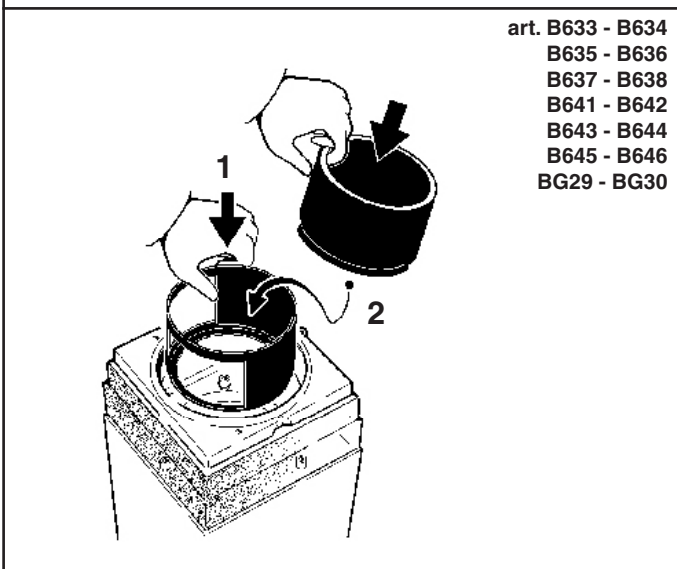
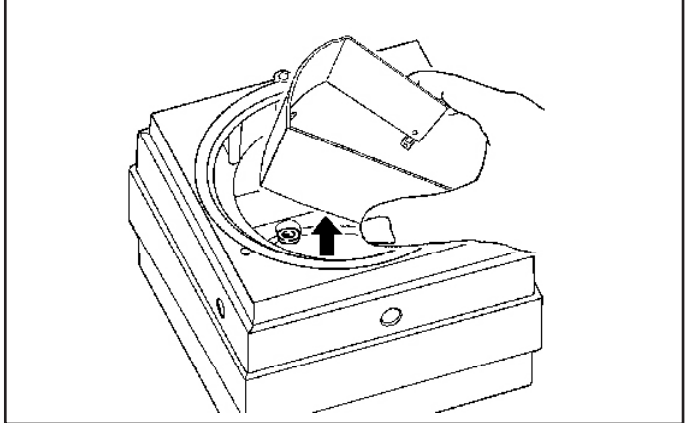
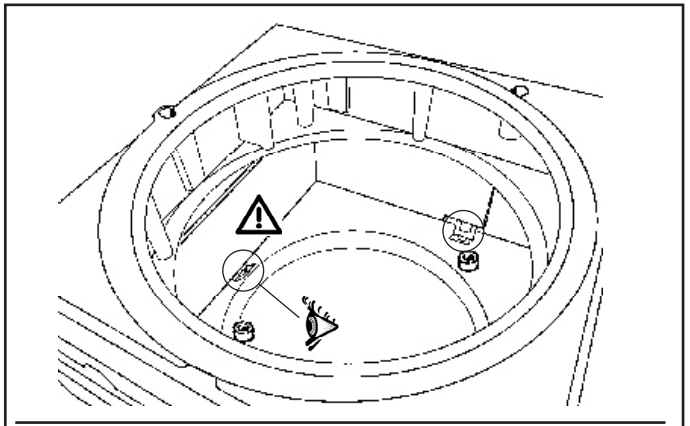
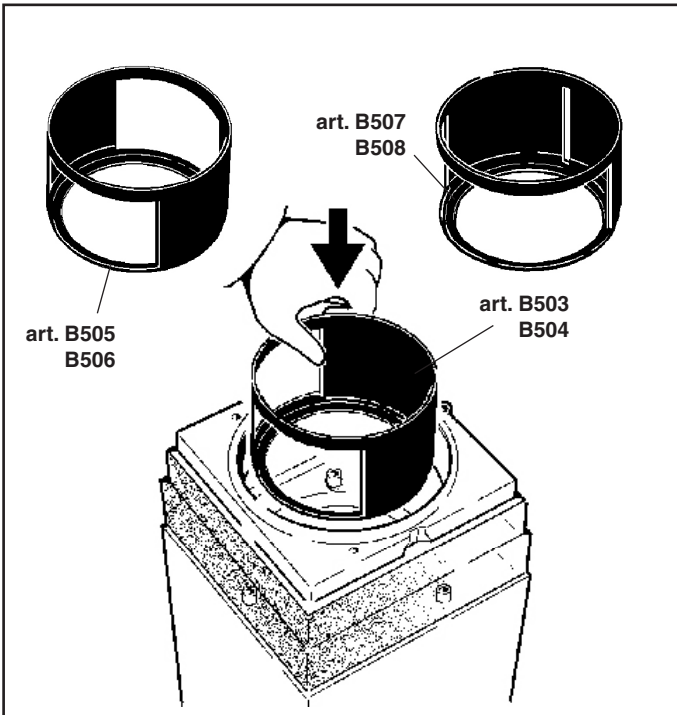

art. X023

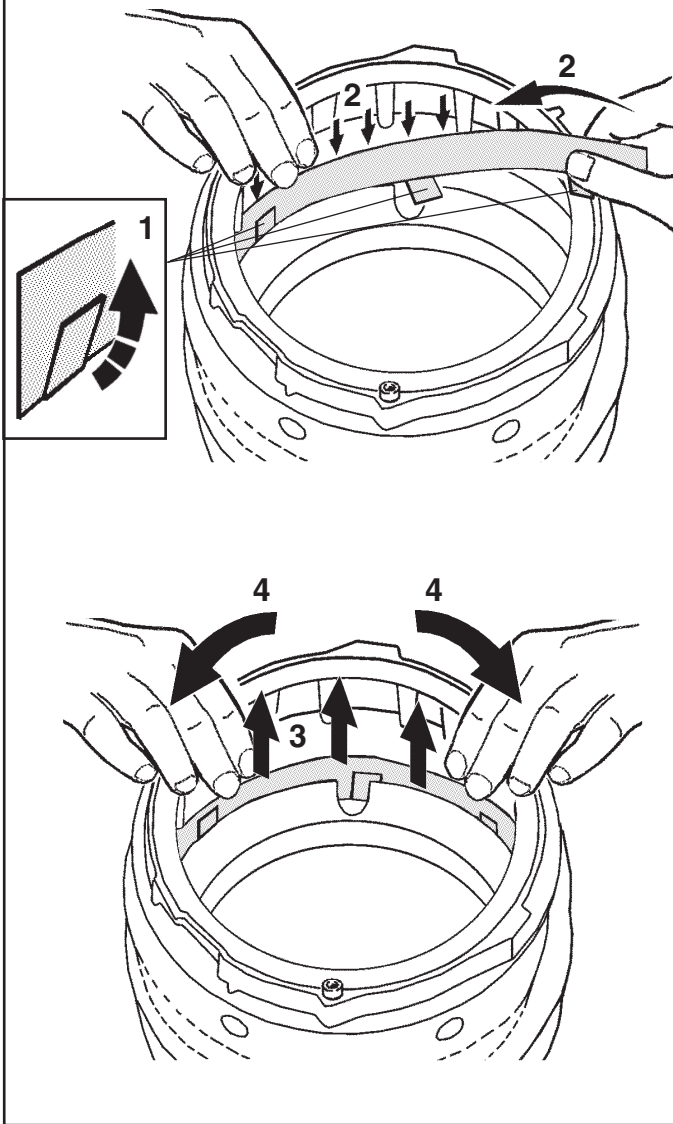

art. X087

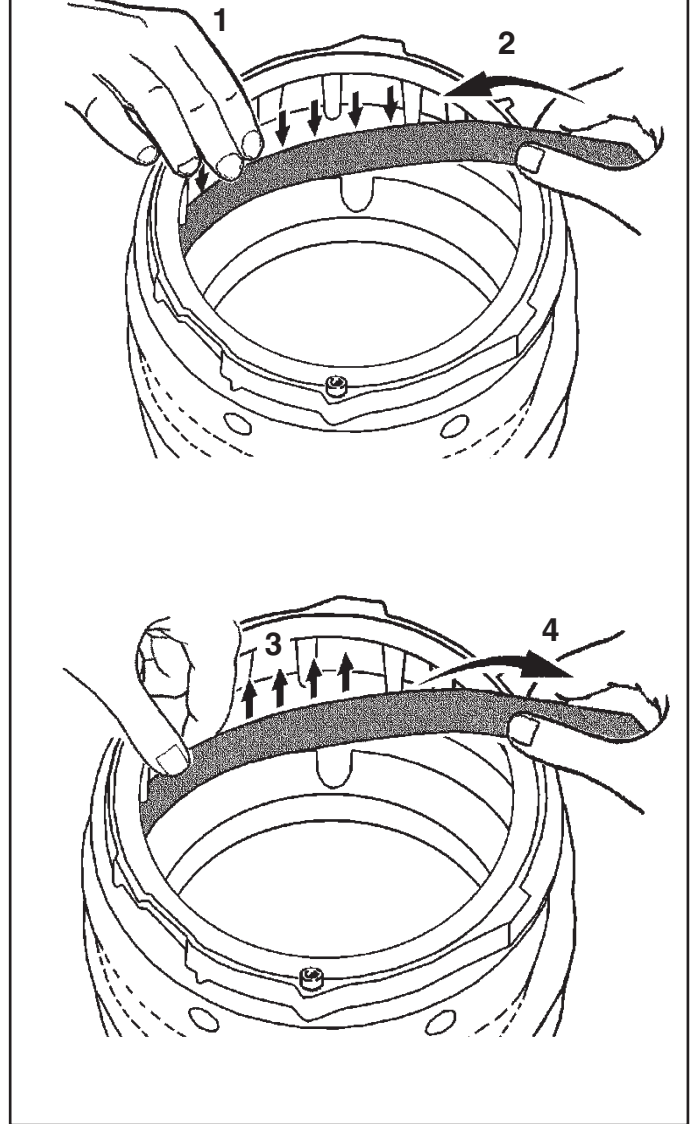

SOSTITUZIONE DEL LED
 REPLACING THE LED
 REMPLACEMENT DE LA LED
 AUSTAUSCHEN DER LED
 VERVANGEN VAN DE LED
 REEMPLAZO DEL LED
 UDSKIFTNING AF LYSDIODE
 BYTE AV LYSDIOD
 UTSKIFTNING AV DEN LYSEMITTERENDE DIODEN
 ЗАМЕНА СИД
 发光二极管替换

- I N.B.: Per la sostituzione del LED contattare l'azienda iGuzzini.
- GB N.B.: For information on LED replacement please contact iGuzzini.
- F N.B.: Pour procéder au remplacement de la LED, adressez-vous à la société iGuzzini.
- D N.B.: Bezüglich des Austausches der LED kontaktieren Sie bitte die Firma iGuzzini.
- NL N.B.: Voor het vervangen van de LED neemt u contact op met het bedrijf iGuzzini.
- E **NOTA:** Para sustituir el LED llame a la empresa iGuzzini.
- DK N.B.: For udsiftingning af den lysemitterende dioden ta kontakt med firmaet iGuzzini.
- N N.B.: For udsiftingning af lysdioden, skal man kontakte iGuzzini.
- S **OBS!** För byte av lysdioden, kontakta företaget iGuzzini.
- RUS **ПРИМЕЧАНИЕ:** Для замены СИДов обращайтесь в компанию iGuzzini.
- CN **注意:** 有关发光二极管照明替换信息,请联系 iGuzzini 公司。

iWAY

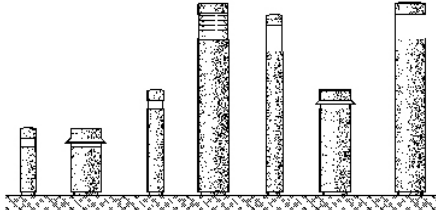

موضع التركيب

POSIZIONE D'INSTALLAZIONE
INSTALLATION POSITION
POSICION DE INSTALACION

Pag.1

المسافة بين مراكز الثقوب

INTERASSI DI FORATURA
CENTRE TO CENTRE DISTANCE BETWEEN HOLES
ENTRE-AXES DE PERCAGE
DISTANCIA ENTRE LOS EJES DE PERFORACIÓN

Pag. 2

التمديدات الكهربائية

CABLAGGIO ELETTRICO
ELECTRIC WIRING
CABLAJE ELÉCTRICO

Pag. 3

تركيب واستبدال اللمبة

INSTALLAZIONE E SOSTITUZIONE DELLA LAMPADA
INSTALLING AND REPLACING THE LAMP
INSTALACIÓN Y REEMPLAZO DEL FOCO

Pag. 8

تركيب واستبدال زجاج الحماية

INSTALLAZIONE E SOSTITUZIONE DEL VETRO DI PROTEZIONE
INSTALLING AND REPLACING THE PROTECTION GLASS
INSTALACION Y REEMPLAZO DEL CRISTAL DE PROTECCION

Pag. 10

تركيب الملحقات

INSTALLAZIONE DEGLI ACCESSORI
INSTALLING THE ACCESSORIES
INSTALACION DE ACCESORIOS

Pag. 10

تحذير :

لا يمكن ضمان سلامة هذا الجهاز إلا إذا التزمت بهذه التعليمات. يجب حفظها في مكان آمن.

ATTENZIONE:
LA SICUREZZA DELL'APPARECCHIO E' GARANTITA SOLO CON L'USO APPROPRIATO DELLE SEGUENTI ISTRUZIONI; PERTANTO E' NECESSARIO CONSERVARLE.

WARNING:
THE SAFETY OF THIS FIXTURE IS GUARANTEED ONLY IF YOU COMPLY WITH THESE INSTRUCTIONS; REMEMBER TO CONSERVE IN A SAFE PLACE.

ATENCION:
LA SEGURIDAD DEL APARATO SE GARANTIZA SOLO CUMPLIENDO CUIDADOSAMENTE LAS SIGUIENTES INSTRUCCIONES; POR ELLO, ES NECESARIO CONSERVARLAS.

ملاحظة: ملاحظة: أثناء تركيب نظام . يجب التقيد بحرص بالنظم السائدة المتعلقة بالشبكة الكهربائية.

N.B.: DURANTE L'INSTALLAZIONE DEL SISTEMA "iWAY" RISPETTARE SCRUPOLOSAMENTE LE NORME IMPIANTISTICHE VIGENTI.

N.B.: WHEN INSTALLING THE SYSTEM "iWAY", STRICTLY COMPLY WITH ALL REGULATIONS ON INSTALLATION IN FORCE.

N.B.: DURANTE LA INSTALACIÓN DEL SISTEMA "iWAY" RESPETAR ESCRUPULOSAMENTE LAS NORMAS DE INSTALACIÓN VIGENTES.

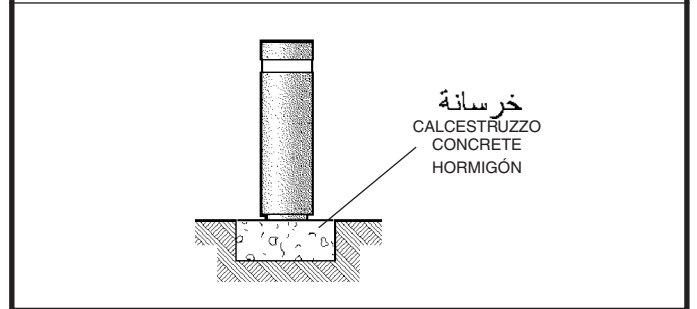
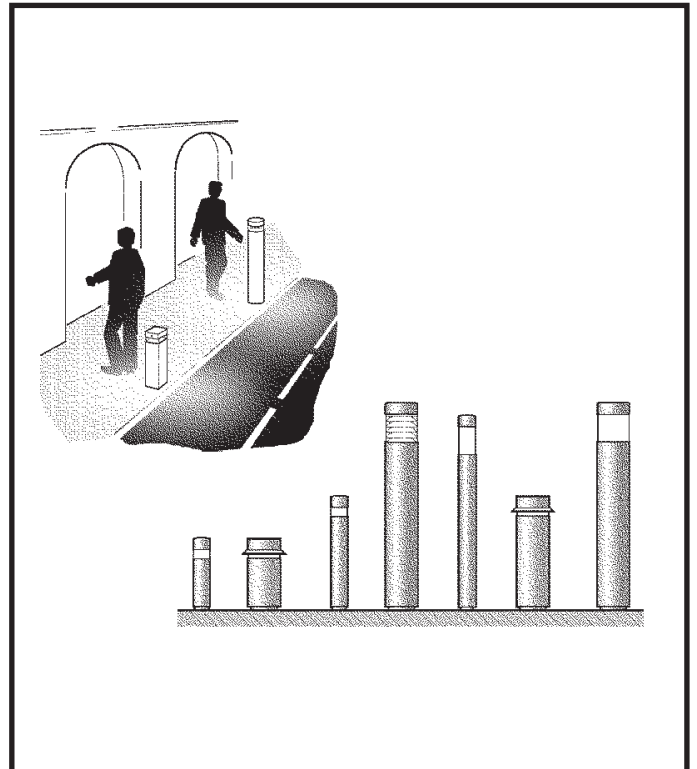
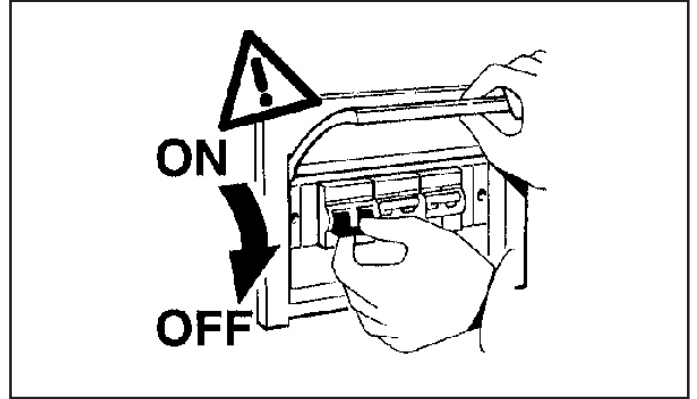

ملاحظة: عند تركيب الجهاز يجب مراعاة عدم دفن القاعدة أو وضعها في الأماكن المعرضة للرطوبة بالمياه.

I N.B.: Installando l'apparecchio, evitare che la base venga interrata o posizionata in punti soggetti al ristagno dell'acqua.

GB N.B.: Whilst installing the appliance, avoid concealing its base or placing it in areas which are susceptible to damp.

E NOTA: Al instalar el aparato, evite que la base se entierre o se coloque en puntos donde se pueda estancar el agua.

الصنف art. B461
B462 - B463 - B464
B465 - B466 - B467
B473 - B474 - B475
B476 - B477 - B478
B633 - B634 - B635
B636 - B637 - B638
BG25 - BG29 - BG23
BG24 - MR81 - MR82
MR83 - MR84 - BW60
BW61 - BW62 - BW63
BW64 - BW65 - BW74
BW75 - BW76 - BW77
BW78 - BW79

جانب المشاة أو الدراجات الهوائية
LATO PEDONALE O CARRABILE
PEDESTRIAN OR VEHICULAR SIDE
LADO PEATONAL O VEHICULAR

الصنف art. B481
B482 - B483 - B484
B485 - B486 - B487
B641 - B642 - B643
B644 - B645 - B646
BG28 - BG30 - BG26
BG27 - MR85 - MR86
MR87 - MR88 - BW66
BW67 - BW68 - BW69
BW70 - BW71 - BW80
BW81 - BW82 - BW83
BW84 - BW85

عند التثبيت ينصح باستخدام مسامير كبيرة نوع FZA-I-M 8 أو ما شابهها ومن صنع شركات أخرى.

PER IL FISSAGGIO SI CONSIGLIA DI UTILIZZARE TASSELLI PER ANCORAGGI PESANTI TIPO FZA-I-M 8 FISCHER, O SIMILARI ANCHE DI ALTRI COSTRUTTORI.

FOR FIXING USE HEAVY DUTY PLUGS, SUCH AS FZA-I-M 8 FISCHER OR SIMILAR, INCLUDING FROM OTHER MANUFACTURERS.

PARA LA FIJACIÓN SE RECOMIENDA UTILIZAR TACOS PARA ANCLAJES DE GRAN RESISTENCIA, TIPO FZA-I-M 8 FISCHER, O SIMILARES, INCLUSO DE OTROS FABRICANTES.

تركيب مع الصنف B513

INSTALLAZIONE CON L'ART. B513
INSTALLATION WITH ART. B513
INSTALACION CON ART. B513

خرسانة
CALCESTRUZZO
CONCRETE
HORMIGÓN

الصنف art. B513

الصنف ART.	X (mm) ملم	V (mm) ملم	الصنف art.
B461 - B462 - B463 - B464 - B465 B466 B467 - B474 - B473 - B475 B476 - B477 - B478 - B481 - B482 B483 - B484 - B485 - B486 - B487 B633 - B634 - B635 - B636 - B637 B638 - B641 - B642 - B643 - B644 B645 - B646 - BG23 - BG24 - BG25 BG28 - BG26 - BG27 - BG29 - BG30 MR81 - MR82 - MR83 - MR84 - MR85 MR86 - MR87 - MR88 - BW60 - BW61 BW62 - BW63 - BW64 - BW65 - BW74 BW75 - BW76 - BW77 - BW78 - BW79 BW66 - BW67 - BW68 - BW69 - BW70 BW71 - BW80 - BW81 - BW82 - BW83 BW84 - BW85	56	M 8	B513

ملحوظة هامة: تعد أبعاد القاعدة المذكورة بغرض إرشادي فقط وقد تم قياسها مع الأخذ في الاعتبار بأن الأرضية تتحمل ضغط 1,0 بار (1,0 كجم /سم²)

I N.B.: Le dimensioni del Plinto sono fornite a titolo indicativo, sono state calcolate considerando un terreno con pressione ammissibile di 1,0bar (1,0 kg /cm²)

GB N.B.: The dimensions of the plinth are purely indicative and were calculated taking into account a surface with an allowable pressure of 1.0 bar (1.0 kg/cm²)

E NOTA: Las medidas de Plinto son sólo indicativas, han sido calculadas considerando un terreno con presión admisible de 1,0bar (1,0 kg /cm²)



عند التثبيت ينصح باستخدام مسامير كبيرة نوع FZA-I-M 6 أو ما شابهها ومن صنع شركات أخرى.

تركيب مع الصنف B514
 INSTALLAZIONE CON L'ART. B514
 INSTALLATION WITH ART. B514
 INSTALACION CON ART. B514

PER IL FISSAGGIO SI CONSIGLIA DI UTILIZZARE TASSELLI PER ANCORAGGI PESANTI TIPO FZA-I-M 6 FISCHER, O SIMILARI ANCHE DI ALTRI COSTRUTTORI.
 FOR FIXING USE HEAVY DUTY PLUGS, SUCH AS FZA-I-M 6 FISCHER OR SIMILAR, INCLUDING FROM OTHER MANUFACTURERS.
 PARA LA FIJACIÓN SE RECOMIENDA UTILIZAR TACOS PARA ANCLAJES DE GRAN RESISTENCIA, TIPO FZA-I-M 6 FISCHER, O SIMILARES, INCLUSO DE OTROS FABRICANTES.

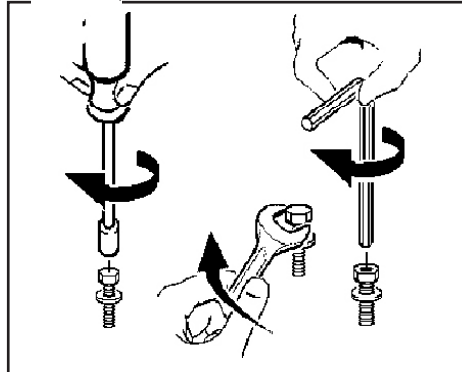
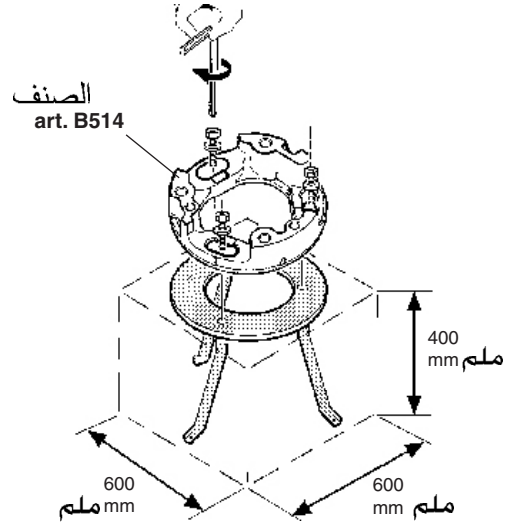
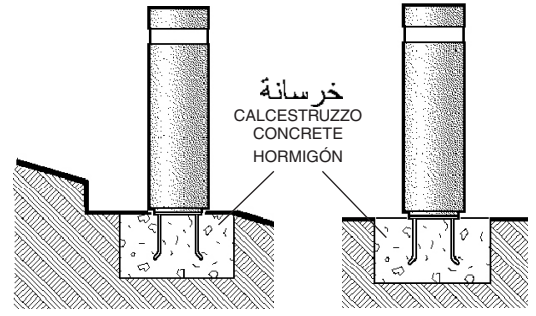
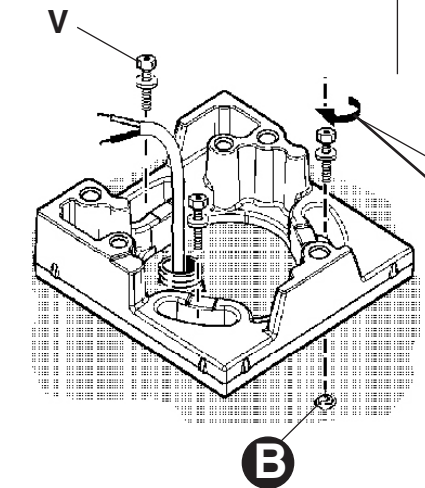
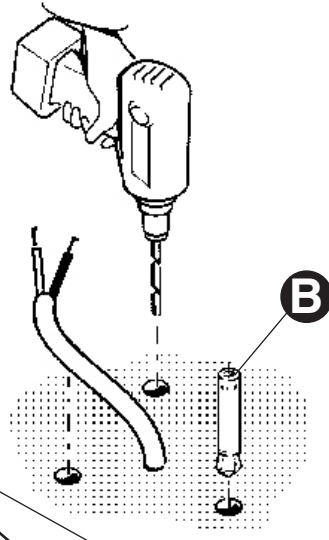
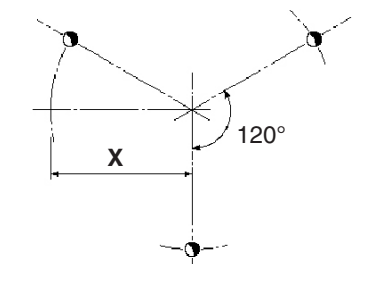

الصنف ART.	X (mm) ملم	V (mm) ملم	art.
B468 - B469 B472 - B479 B480 - B488 - B489 B492 - B639 - B640 B647 - B648 BG19 - BG20 BG21 - BG22	32	M 6	B514

ملحوظة هامة: تعد أبعاد القاعدة المذكورة بفرض إرشادي فقط وقد تم قياسها مع الأخذ في الاعتبار بأن الأرضية تتحمل ضغط 1,0 بار (1,0 كجم /سم²)
 I N.B.: Le dimensioni del Plinto sono fornite a titolo indicativo, sono state calcolate considerando un terreno con pressione ammissibile di 1,0bar (1,0 kg /cm²)
 GB N.B.: The dimensions of the plinth are purely indicative and were calculated taking into account a surface with an allowable pressure of 1.0 bar (1.0 kg/cm²)
 E NOTA: Las medidas de Plinto son sólo indicativas, han sido calculadas considerando un terreno con presión admisible de 1,0bar (1,0 kg /cm²)

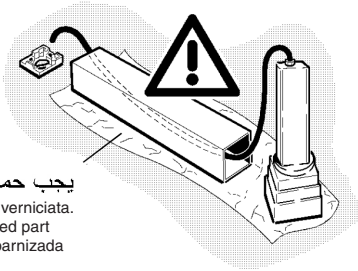

يجب حماية الجزء المطلي.
Proteggere la parte verniciata.
Protect the painted part
Proteger la parte barnizada

التمديدات الكهربائية

CABLAGGIO ELETTRICO
ELECTRIC WIRING
CABLEADO ELÉCTRICO

استعمل كبلًا يعازل مزدوج للتمديدات الكهربائية.

- ع
I Per il cablaggio elettrico utilizzare cavi con doppio isolamento.
GB Use cable with double insulation for the electric wiring.
E Para el cableado eléctrico servirse de cables con doble aislamiento.

في حال تلف الكبل الخارجي المرين، يجب تغييره من قبل
المصنع أو من قبل مركز الخدمة المخول أو من قبل أحد
أعضاء الطاقم الملائمين والمؤهلين وذلك لتحاكي إلحاق أي
خطر.

- I In caso di danneggiamento del cavo flessibile esterno, questo deve essere sostituito dal costruttore, o dal suo servizio di assistenza, o da personale qualificato equivalente, al fine di evitare pericoli.
GB Should the outer flexible cable be somehow damage, the latter should be replaced by the manufacturer, or by the corresponding service centre, or by an appropriate and qualified member of staff in order to avoid all risk of danger.
E En caso de daños el cable flexible externo debe substituirse por el fabricante, su servicio de asistencia o personal calificado equivalente para evitar peligros.

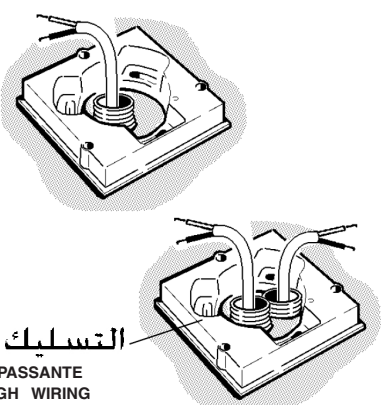

التسليك من خلال
CABLAGGIO PASSANTE
FEEDTHROUGH WIRING
CABLEADO PASANTE

ملاحظة: عند التوصيل بالشبكة الكهربائية يجب استخدام تصنيف B511 - B512 أو ليزت عن
توصيل من الفئة II التي تضمن حماية من الدرجة IP66 .

- I N.B.: Per il collegamento elettrico alla rete, servirsi dell'art. B511 - B512 o di altri dispositivi di connessione in classe II che garantiscano il grado di protezione IP66.
GB N.B.: To connect to the mains, use art. B511 - B512 or other class II connection devices which guarantee an IP66 degree of protection.
E NOTA: Para conexión eléctrica a la red, utilizar e art. B511 - B512 u otros dispositivos de conexión en clase II, para garantizar grado de protección IP66 .

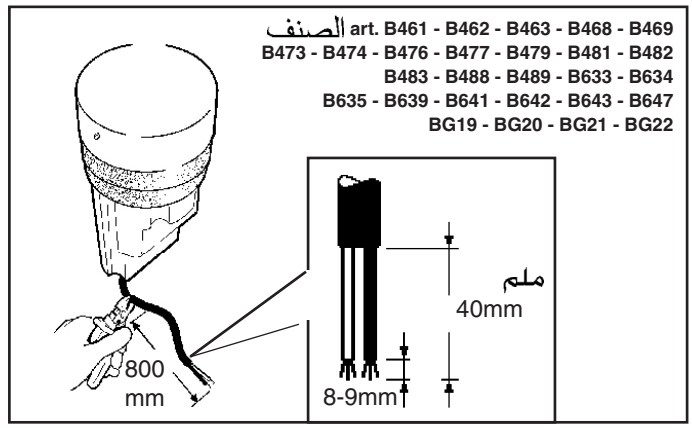

الاصنف art. B461 - B462 - B463 - B468 - B469
B473 - B474 - B476 - B477 - B479 - B481 - B482
B483 - B488 - B489 - B633 - B634
B635 - B639 - B641 - B642 - B643 - B647
BG19 - BG20 - BG21 - BG22

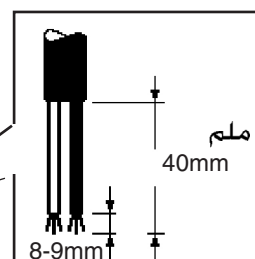
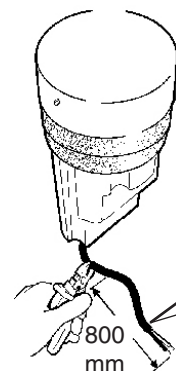

الاصنف ART.	عدد المنتجات القابلة للتوصيل / مقطع الكبل N° Prodotti collegabili / Sezione cavo No. of products that can be connected / Cable cross section. N° de productos a conectar / Sección del cable		
	1,5 mm ²	2,5 mm ²	4 mm ²
B466 - B486 - B638 - B646	25	37	45
B461 - B462 - B464 - B465 B481 - B482 - B484 - B485 B633 - B634 - B636 - B637 B641 - B642 - B644 - B645	50	75	97
B463 - B467 - B468 - B472 B483 - B487 - B488 - B492 B635 - B639 - B640 - B643 B647 - B648 - BG23 - BG24 BG25 - BG26 - BG27 - BG28 BG29 - BG30 - MR81 - MR82 MR83 - MR84 - MR85 MR86 - MR87 - MR88 BW60 - BW61 - BW62 BW63 - BW64 - BW65 BW74 - BW75 - BW76 BW77 - BW78 - BW79 BW66 - BW67 - BW68 BW69 - BW70 - BW71 BW80 - BW81 - BW82 BW83 - BW84 - BW85	97	134	173
B469 - B489 - BG19 - BG20 BG21 - BG22	120	160	200
B473 - B475 - B476 - B478	45	60	80
B474 - B477	107	147	190
B479 - B480	148	203	266

الاصنف ART.	art. B511	art. B512	art. BZG8	art. BZH0
B461 - B462 - B463 - B464 - B465 B466 - B467 - B473 - B474 - B475 B476 - B477 - B478 - B481 - B482 B483 - B484 - B485 - B486 - B487 B633 - B634 - B635 - B636 - B637 B638 - B641 - B642 - B643 - B644 B645 - B646 - MR81 - MR82 - MR83 MR84 - MR85 - MR86 - MR87 - MR88 BW62 - BW63 - BW64 - BW65 - BW68 BW69 - BW70 - BW71 - BW76 - BW77 BW78 - BW79 - BW81 - BW82 - BW83 BW84 - BW85	●			
B468 - B469 - B472 - B479 - B480 B488 - B489 - B492 - B639 - B640 B647 - B648 - BG19 - BG20 - BG21 BG22		●		
BG23 - BG24 - BG25 - BG26 - BG27 BG28 - BG29 - BG30 - BW60 - BW61 BW66 - BW67 - BW74 - BW75 - BW80 BW81			●	●

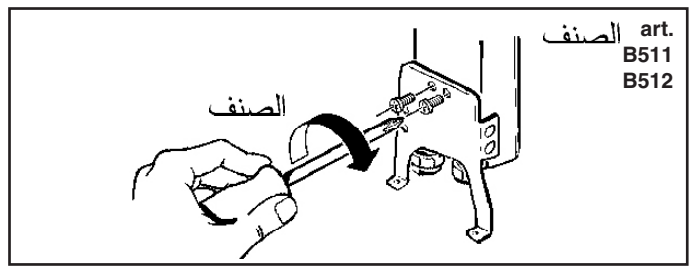

الاصنف art.
B511
B512

OK

MIN 2÷3 mm ملم

D

	D (mm)	Ø (mm)
1	3,5 ÷ 8,0	6
2	7,0 ÷ 14,0	11 ÷ 12

التسليك من خلال

CABLAGGIO PASSANTE
FEEDTHROUGH WIRING
CABLEADO PASANTE

مصدر التيار

ALIMENTAZIONE
POWER SUPPLY
CEBADOR

المقطع - Sezione
Section - Sección
(MAX 6 mm²)

ملم 8÷9 mm

ملم 50 mm

التسليك من خلال

CABLAGGIO PASSANTE
FEEDTHROUGH WIRING
CABLEADO PASANTE

مصدر التيار

ALIMENTAZIONE
POWER SUPPLY
CEBADOR

التسليك من خلال

CABLAGGIO PASSANTE
FEEDTHROUGH WIRING
CABLEADO PASANTE

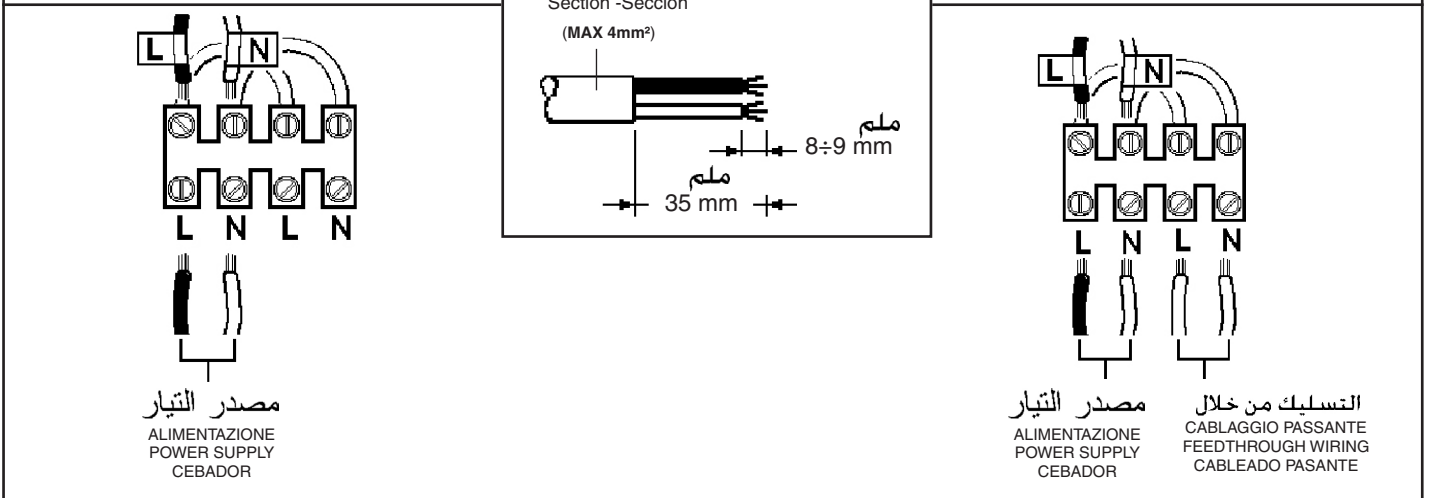
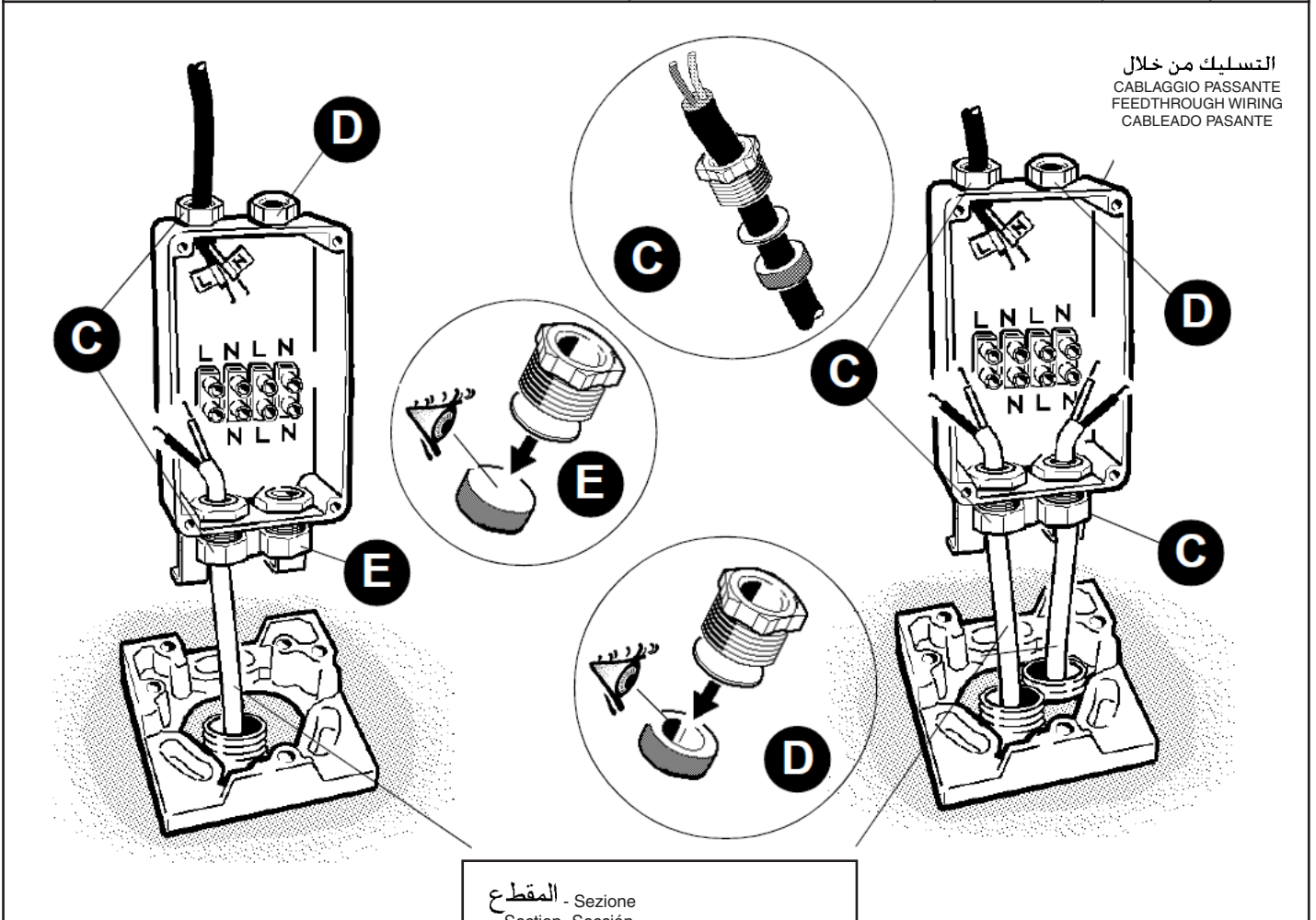
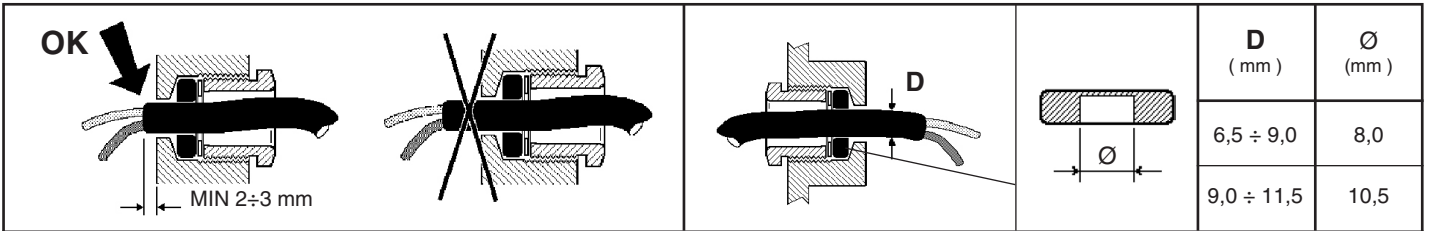

الصف art. B511
B512

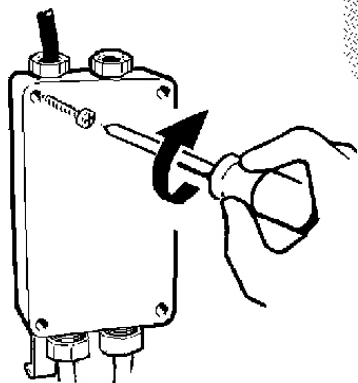
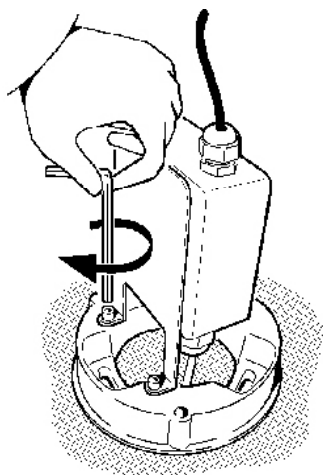

الصف art. BG23 - BG24 - BG25 - BG26 - BG27 - BG28
BG29 - BG30 - BW60 - BW61 - BW66
BW67 - BW74 - BW75 - BW80
BW81

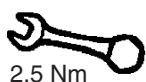
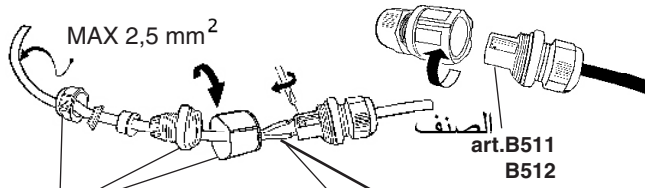

2,5 Nm

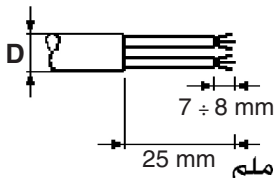
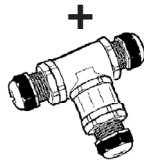

7 ÷ 8 mm

25 mm ملم

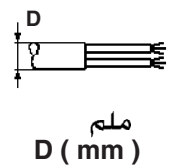

D (mm) ملم

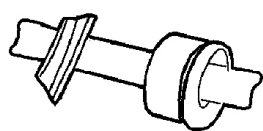

6,5 ÷ 8 mm ملم

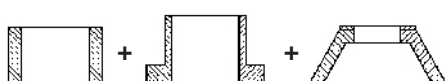

8 ÷ 9 mm ملم

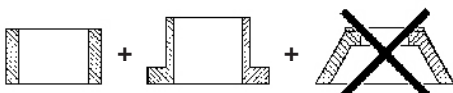

9 ÷ 13 mm ملم

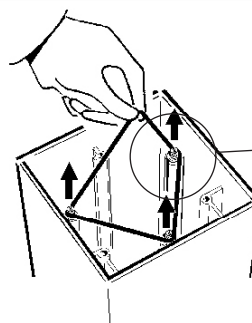
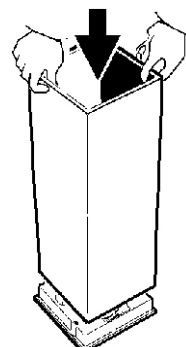
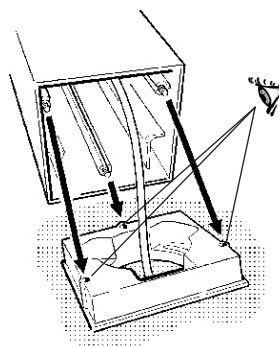

أزل الأشرطة المطاطية قبل استخدام المنتج.

- I Prima di utilizzare il prodotto asportare gli elastici.
- GB Remove the elastic bands before using the product.
- E Remover los elásticos antes de utilizar el producto.

ثبته بإحكام
Serrare a fondo
Tighten firmly
Enrosacar en firm

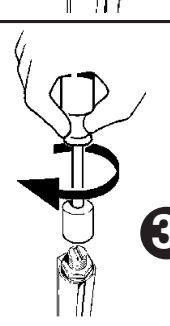
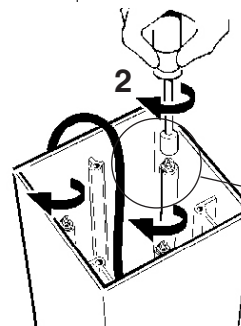
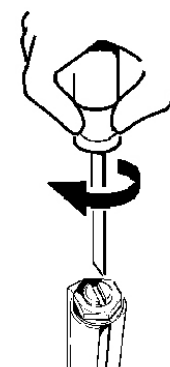
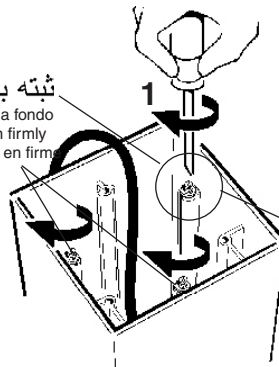

الصف ART.

3

B461 - B462 - B463 - B464 - B465 - B466 - B467 - B473
B474 - B475 - B476 - B477 - B478 - B481 - B482 - B483
B484 - B485 - B486 - B487 - B633 - B634 - B635 - B636
B637 - B638 - B641 - B642 - B643 - B644 - B645 - B646
BG23 - BG24 - BG25 - BG26 - BG27 - BG28 - BG29 - BG30
MR81 - MR82 - MR83 - MR84 - MR85 - MR86 - MR87
MR88 - BW60 - BW61 - BW62 - BW63 - BW64 - BW65
BW74 - BW75 - BW76 - BW77 - BW78 - BW79 - BW66
BW67 - BW68 - BW69 - BW70 - BW71 - BW80 - BW81
BW82 - BW83 - BW84 - BW85

MAX 10 Nm

B468 - B469 - B472 - B479 - B480 - B488 - B489
B492 - B639 - B640 - B647 - B648 - BG19 - BG20 - BG21
BG22

MAX 5 Nm

جانب المشاة أو الدراجات الهوائية
 LATO PEDONALE O CARRABILE
 PEDESTRIAN OR VEHICULAR SIDE
 LADO PEATONAL O VEHICULAR

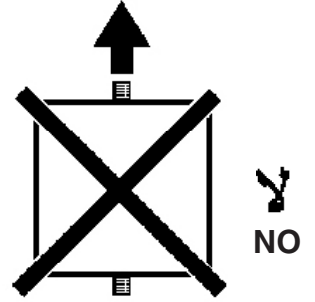
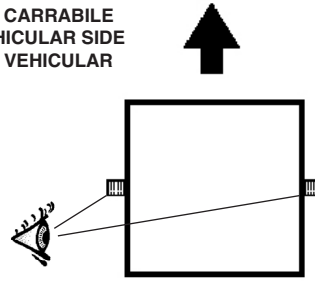
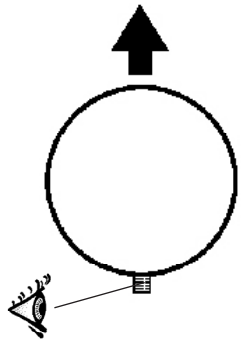

جانب المشاة أو الدراجات الهوائية
 LATO PEDONALE O CARRABILE
 PEDESTRIAN OR VEHICULAR SIDE
 LADO PEATONAL O VEHICULAR

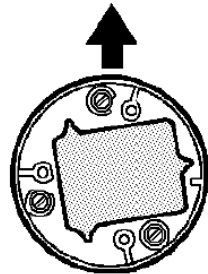
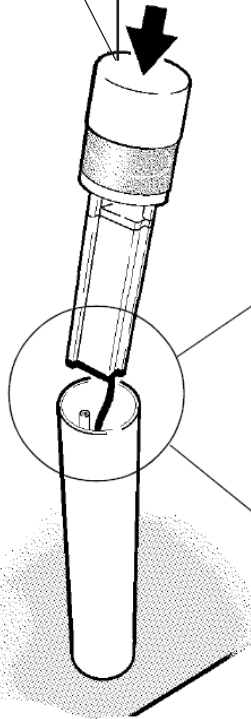

الصف
 art. B468 - B469
 B472 - B479
 B480 - B639
 B640
 BG19 - BG20

جانب المشاة أو الدراجات الهوائية
 LATO PEDONALE O CARRABILE
 PEDESTRIAN OR VEHICULAR SIDE
 LADO PEATONAL O VEHICULAR

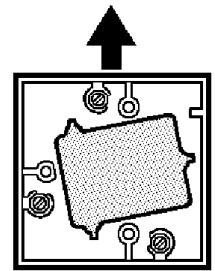
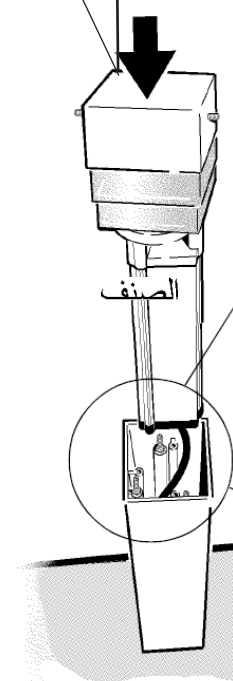

الصف
 art. B488 - B489
 B492 - B647
 B648 - BG21
 BG22



جانب المشاة أو الدراجات الهوائية
 LATO PEDONALE O CARRABILE
 PEDESTRIAN OR VEHICULAR SIDE
 LADO PEATONAL O VEHICULAR

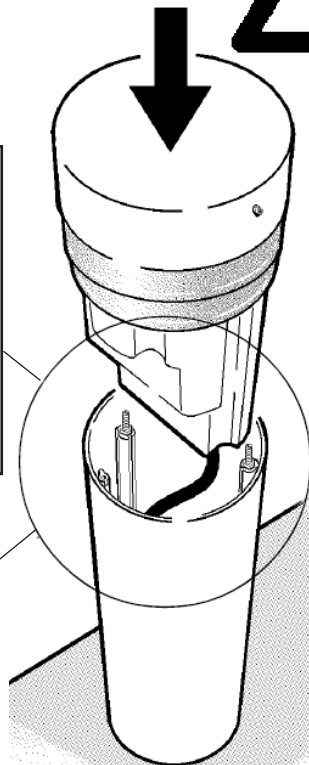
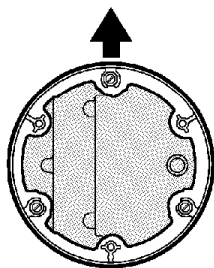

art. B461 - B462 - B463
 B464 - B465 - B466
 B467 - B473 - B474
 B475 - B476 - B477
 B478 - B633 - B634
 B635 - B636 - B637
 B638 - BG23 - BG24
 BG25 - BG29 - MR81
 MR82 - MR83 - MR84
 BW60 - BW61 - BW62
 BW63 - BW64 - BW65
 BW74 - BW75 - BW76
 BW77 - BW78 - BW79

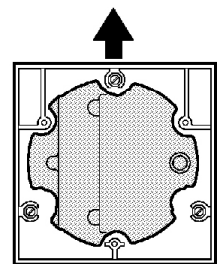
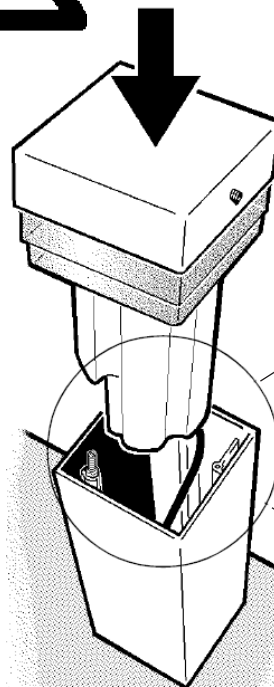

الصف
 art. B481 - B482 - B483
 B484 - B485 - B486
 B487 - B641 - B642
 B643 - B644 - B645
 B646 - BG26 - BG27
 BG28 - BG30 - MR85
 MR86 - MR87 - MR88
 BW66 - BW67 - BW68
 BW69 - BW70 - BW71
 BW80 - BW81 - BW82
 BW83 - BW84 - BW85

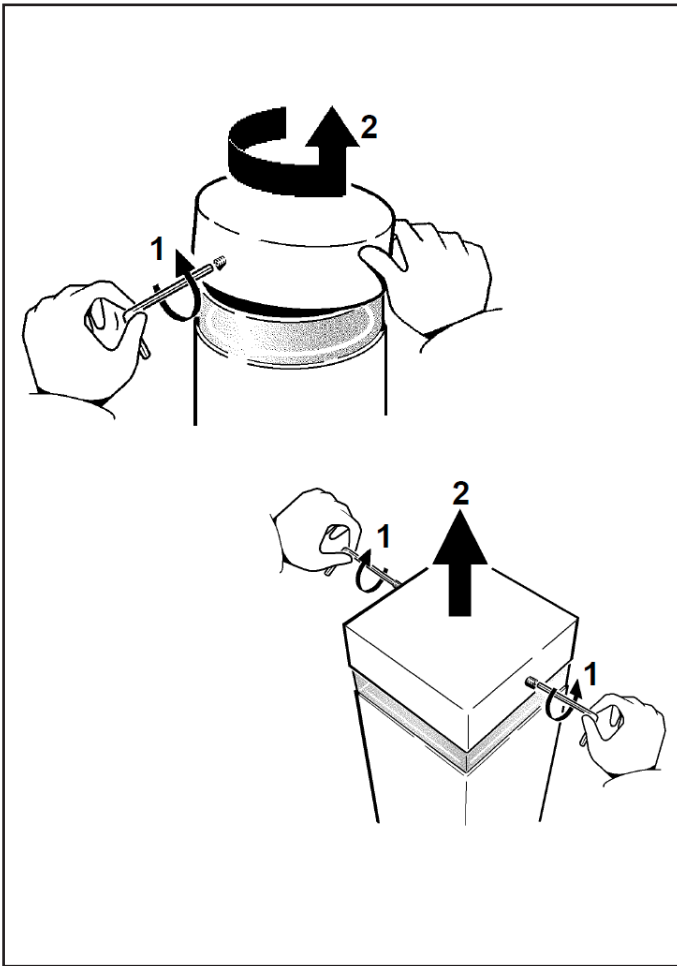

LED VERSION

الصف

art. BG23 - BG24 - BG26 - BG27 - MR81 - MR82 - MR83
 MR84 - MR85 - MR86 - MR87 - MR88 - BW60 - BW61
 BW62 - BW63 - BW64 - BW65 - BW74 - BW75 - BW76
 BW77 - BW78 - BW79 - BW66 - BW67 - BW68 - BW69
 BW70 - BW71 - BW80 - BW81 - BW82 - BW83 - BW84
 BW85 - B469 - B489 - BG19 - BG20 - BG21 - BG22

عر

يجب عدم اللمس المباشر للعاكس

I Evitare qualsiasi contatto diretto con il riflettore.

GB Avoid direct contact with reflector.

E Evitar cualquier contacto directo con el reflector.

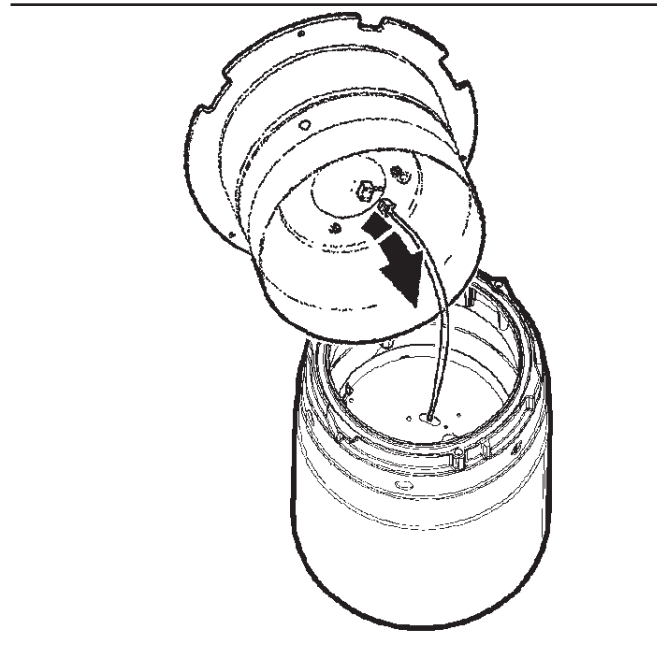
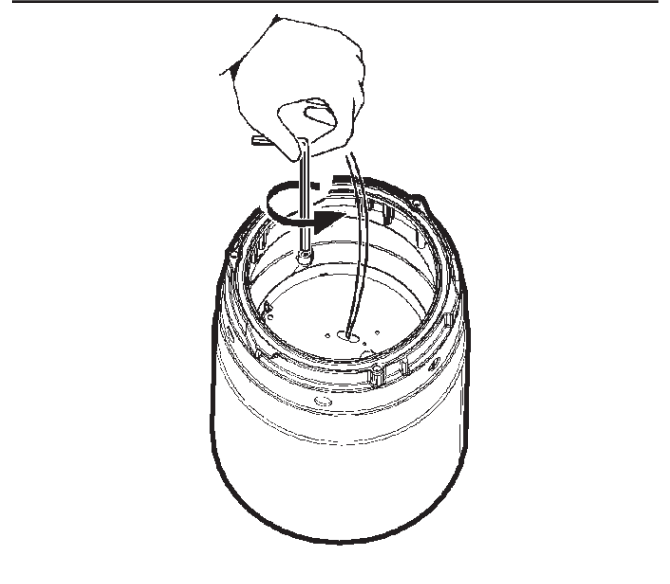
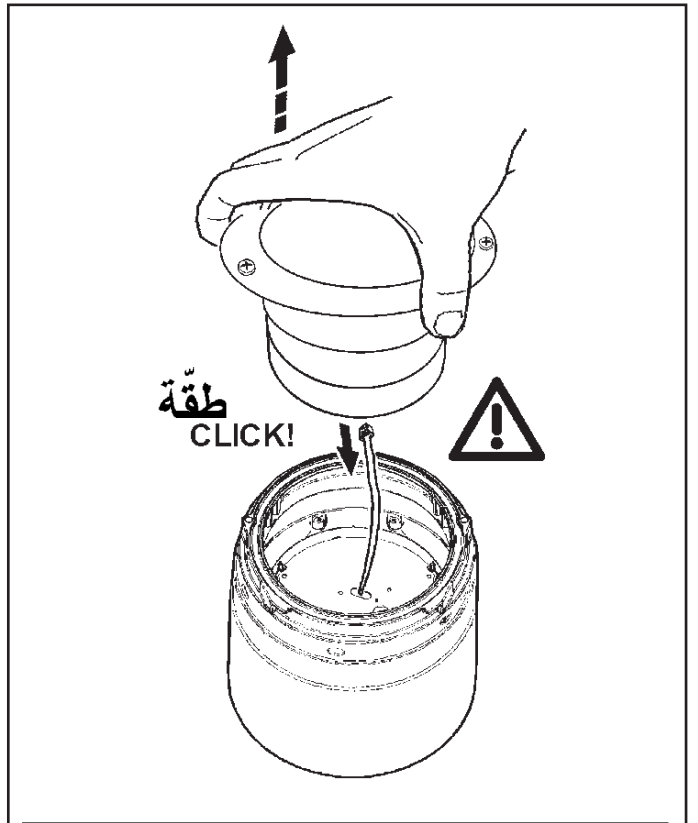
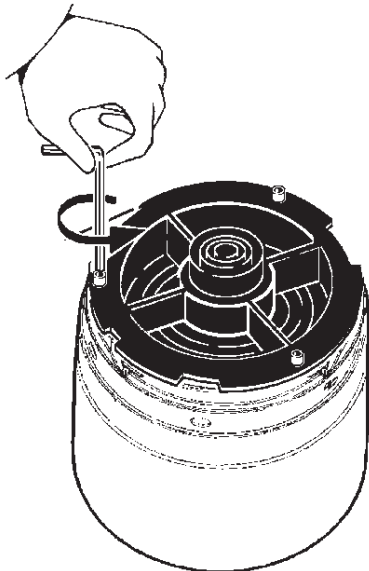

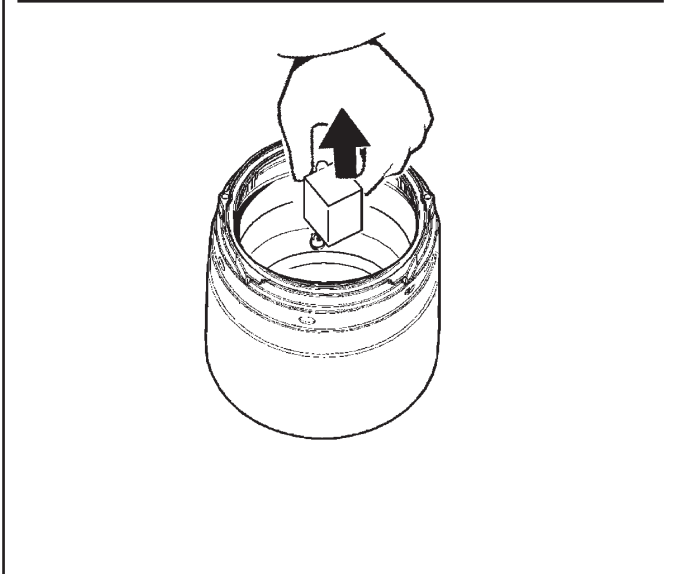
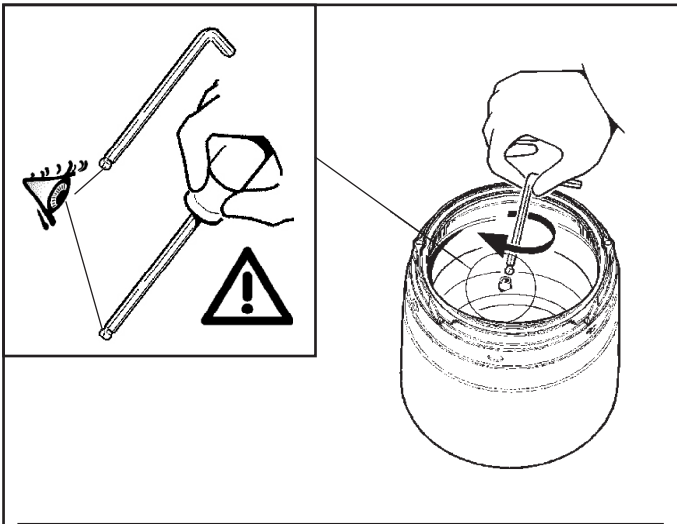

HID VERSION

الصف

art. B461 - B462 - B463 - B464 - B465 - B466 - B467 - B473
 B474 - B475 - B476 - B477 - B478 - B481 - B482 - B483
 B484 - B485 - B486 - B487 - B633 - B634 - B635 - B636
 B637 - B638 - B641 - B642 - B643 - B644 - B645 - B646
 BG25 - BG28 - BG29 - BG30 - B468 - B472 - B479
 B480 - B488 - B492 - B639 - B640 - B647 - B648

ع يجب عدم اللمس المباشر للعاكس

I Evitare qualsiasi contatto diretto con il riflettore.

GB Avoid direct contact with reflector.

E Evitar cualquier contacto directo con el reflector.

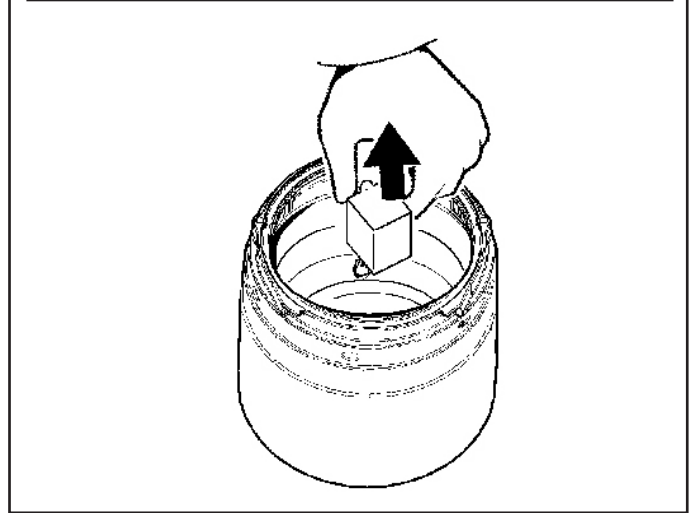
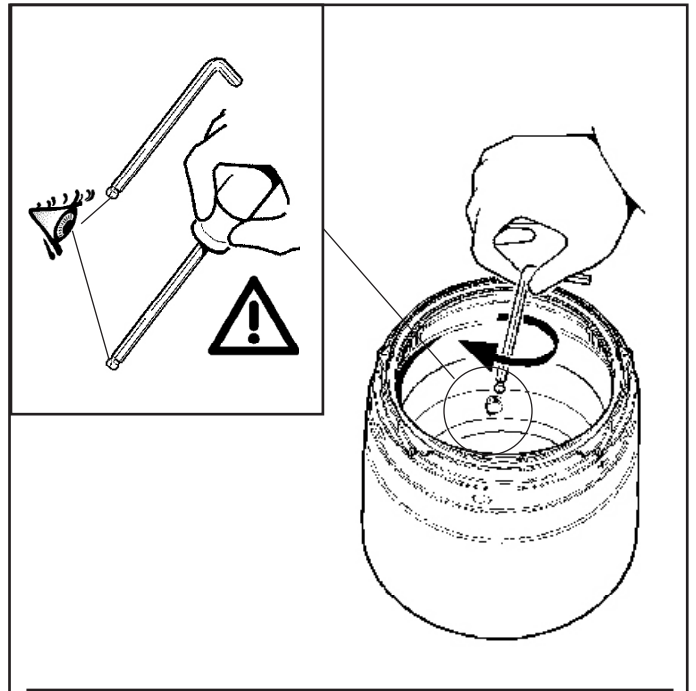
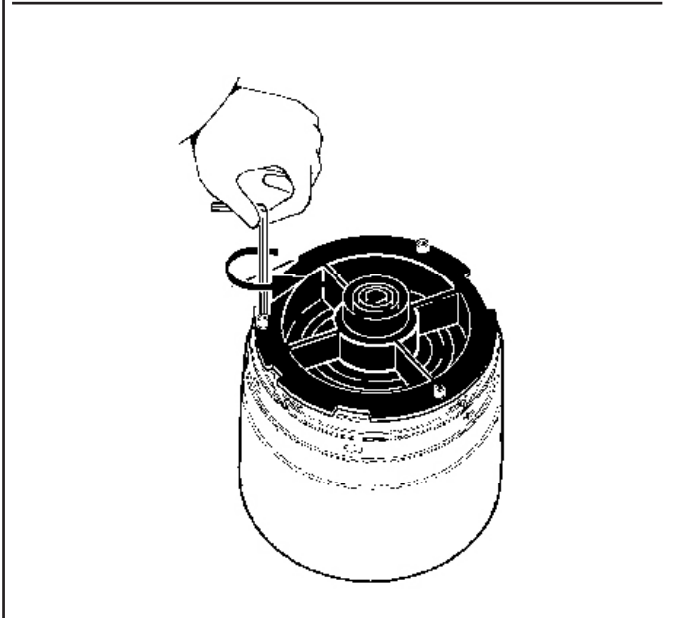

الصف B473

B474

B475

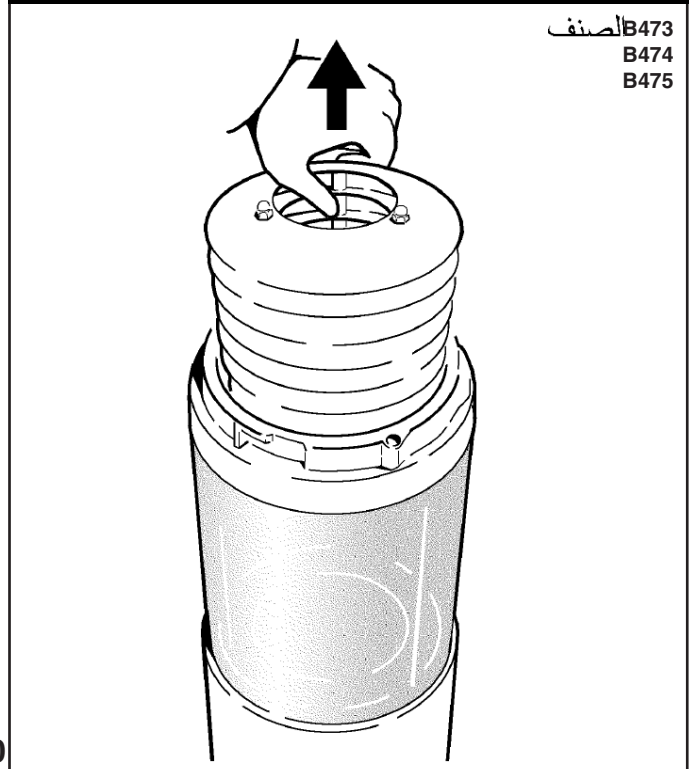

art. B461 - B462 - B464 - B465 - B466 - B481 - B482 - B484
 الصنف B485 - B486 - B633 - B634 - B636 - B637 - B638 - B641
 B642 - B644 - B645 - B646

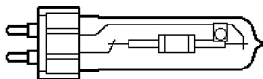

PHILIPS " CDM-T "
 OSRAM " HCI-T "

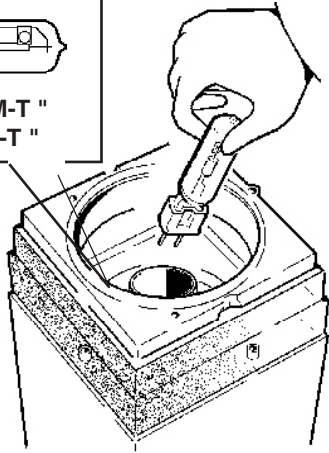

يتم الحصول على تغطية الضوء المصرح عنها من خلال استعمال المصابيح المبيّنة في الشكل. عر
 ملاحظة: تحقق من دخول اللبنة حتى للنهاية في المقعر المتواجد على حامل لللمبة.

I Le prestazioni fotometriche dichiarate a catalogo sono garantite usando le lampade indicate in figura.
 N.B.: Assicurarsi che la lampada sia inserita nella sede del portalampada fino in fondo.

GB The photometric performance indicated in the catalogue is guaranteed when using the shown in the figure.
 N.B.: Make sure that the lamp is properly inserted all the way into the lamp holder.

E Las prestaciones fotométricas que declara el catálogo se garantizan al utilizar las lámparas indicadas en figura.
 NOTA: Comprobar que la bombilla ha sido enroscada en el portalámparas hasta el tope.

الصنف art. B473
 B474
 B475

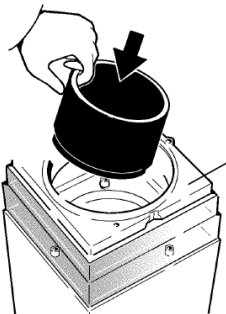
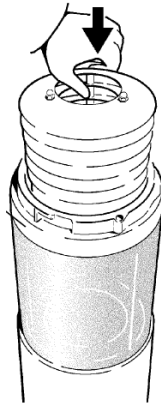

الصنف art. B633 - B634 - B635 - B636
 B637 - B638 - B641 - B642
 B643 - B644 - B645 - B646
 BG29 - BG30

art. B481 - B482 - B483 - B484
 B485 - B486 - B487 - B641
 B642 - B642 - B644 - B645
 B646 - BG26 - BG27 - BG28
 BG30 - MR81 - MR82 - MR83
 MR84 - MR85 - MR86 - MR87
 MR88 - BW60 - BW61 - BW62
 BW63 - BW64 - BW65 - BW74
 BW75 - BW76 - BW77 - BW78
 BW79 - BW66 - BW67 - BW68
 BW69 - BW70 - BW71 - BW80
 BW81 - BW82 - BW83 - BW84
 BW85

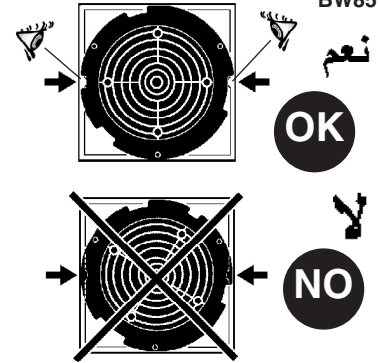
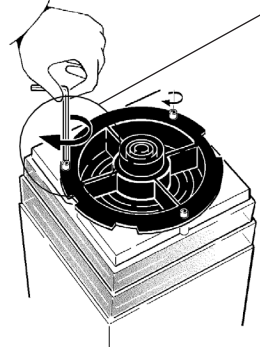

جانب المشاة أو الدراجات الهوائية
 LATO PEDONALE O CARRABILE
 PEDESTRIAN OR VEHICULAR SIDE
 LADO PEATONAL O VEHICULAR

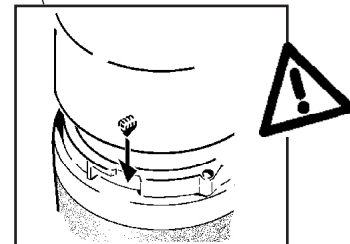
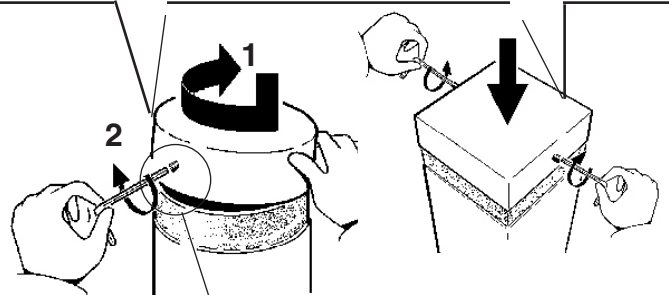
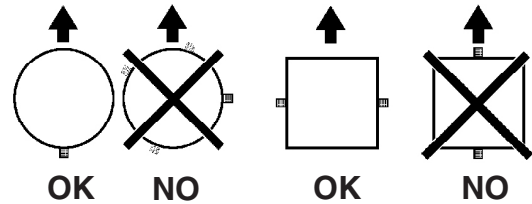

استبدال زجاج الحماية

SOSTITUZIONE DEL VETRO DI PROTEZIONE
 REPLACING THE PROTECTIVE GLASS
 REEMPLAZO DEL CRISTAL DE PROTECCION



لا يمكن استعمال المنتج في حالة كسر الزجاج، وبالتالي يجب الاتصال بالمتابع لاستبداله. عر

I In caso di rottura del vetro il prodotto non può essere utilizzato, contattare il costruttore per la sua sostituzione.

GB Should the glass break, the product cannot be used and you should contact the manufacturer for its replacement.

E No utilizar el producto en caso de ruptura del vidrio y contactar el fabricante para la sustitución.

+ ART. XXXX

ملحق

ACCESSORIO
ACCESSORY
ACCESORIO



الصف ART.	الصف art. B503	الصف art. B504	الصف art. B505	الصف art. B506	الصف art. B507	الصف art. B508
B461	●		●		●	
B462	●		●		●	
B463	●		●		●	
B464	●		●		●	
B465	●		●		●	
B466	●		●		●	
B467	●		●		●	
B468		●		●		●
B469		●		●		●
BG19		●		●		●
BG20		●		●		●
B472		●		●		●
B481	●		●		●	
B482	●		●		●	
B483	●		●		●	
B484	●		●		●	
B485	●		●		●	
B486	●		●		●	
B487	●		●		●	
B488		●		●		●
B489		●		●		●
BG21		●		●		●
BG22		●		●		●
B492		●		●		●
B633	●		●		●	
B634	●		●		●	
B635	●		●		●	
B636	●		●		●	
B637	●		●		●	
B638	●		●		●	
B639		●		●		●
B640		●		●		●
B641	●		●		●	
B642	●		●		●	
B643 - BG25	●		●		●	
B644 - BG28	●		●		●	
B645 - BG29	●		●		●	
B646 - BG30	●		●		●	
B647		●		●		●
B648		●		●		●

+ ART. XXXX

ملحق

ACCESSORIO
ACCESSORY
ACCESORIO



الصف ART.	الصف art. X023	الصف art. X024	الصف art. X087	الصف art. X088
BG23 - BG24				
MR81 - MR82	●		●	
MR83 - MR84				
BG26 - BG27				
MR85 - MR86		●		●
MR87 - MR88				
BW60 - BW61				
BW62 - BW63				
BW64 - BW65	●		●	
BW74 - BW75				
BW76 - BW77				
BW78 - BW79				
BW66 - BW67				
BW68 - BW69				
BW70 - BW71		●		●
BW80 - BW81				
BW82 - BW83				
BW84 - BW85				

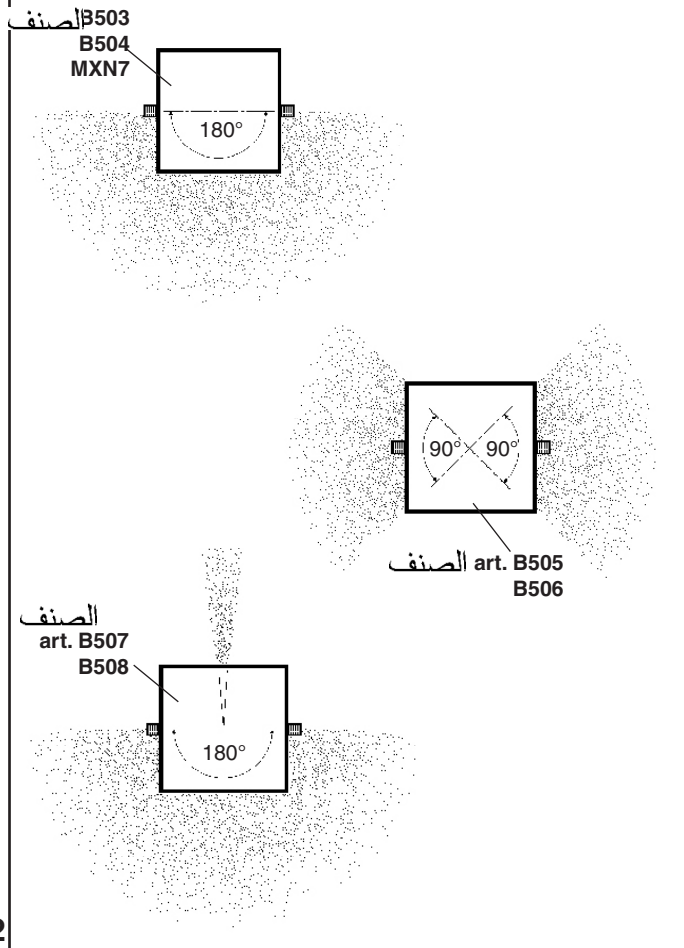

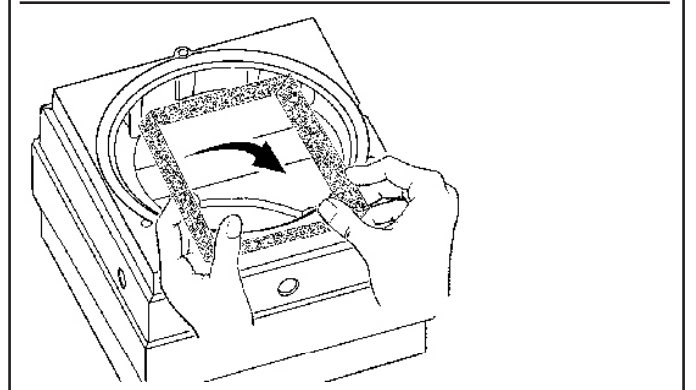
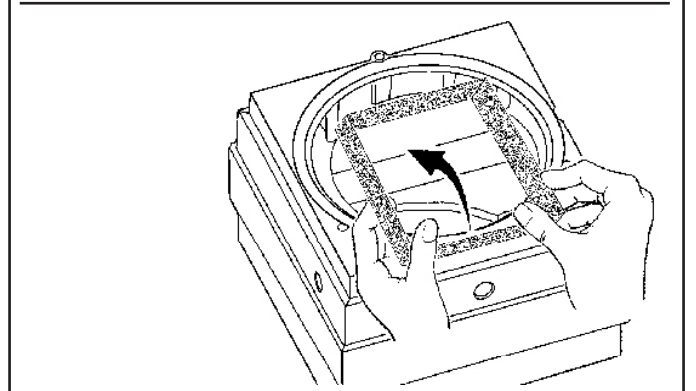
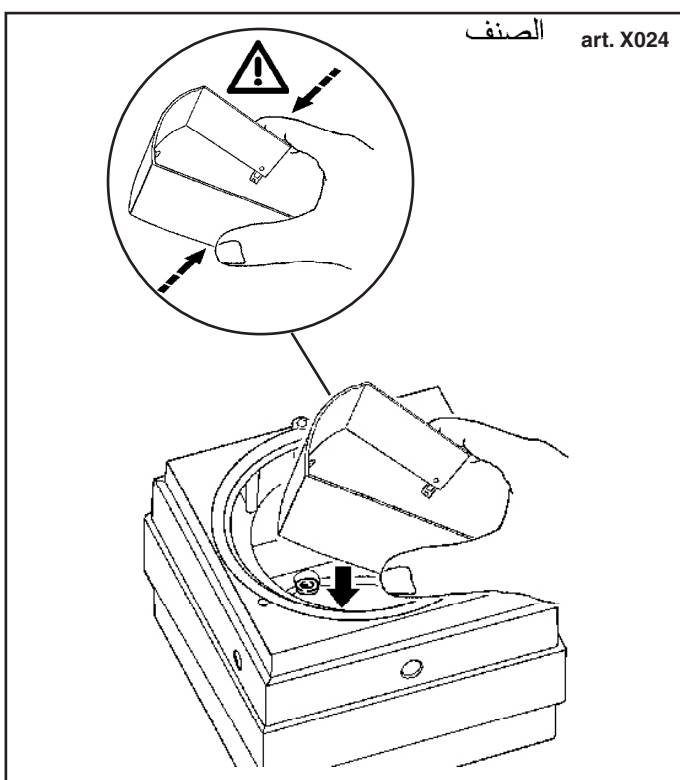
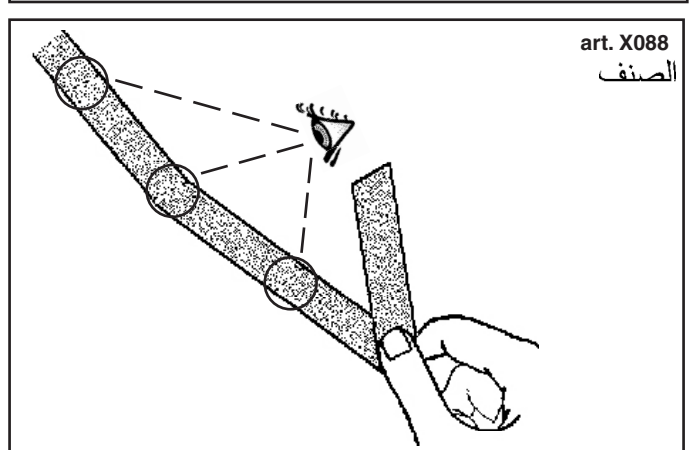
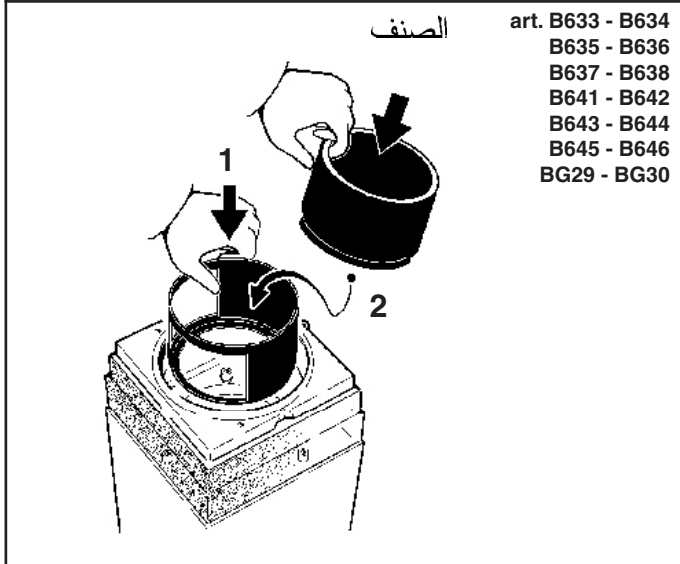
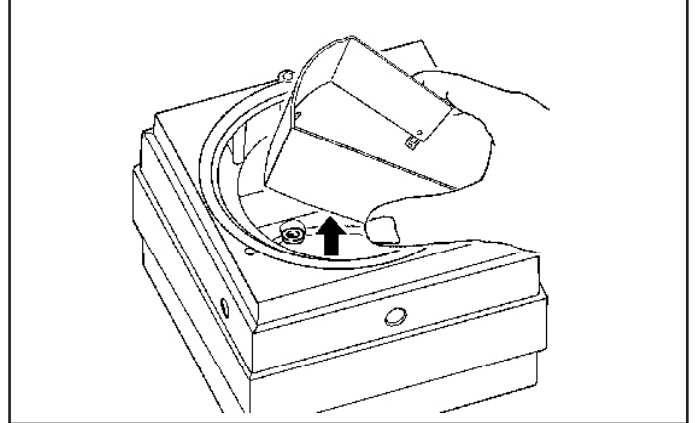
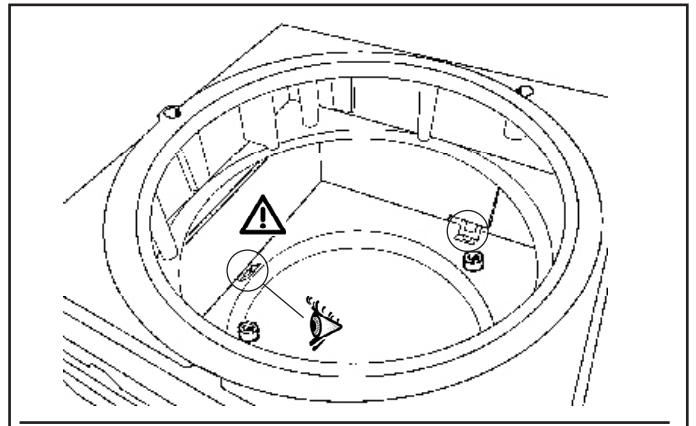
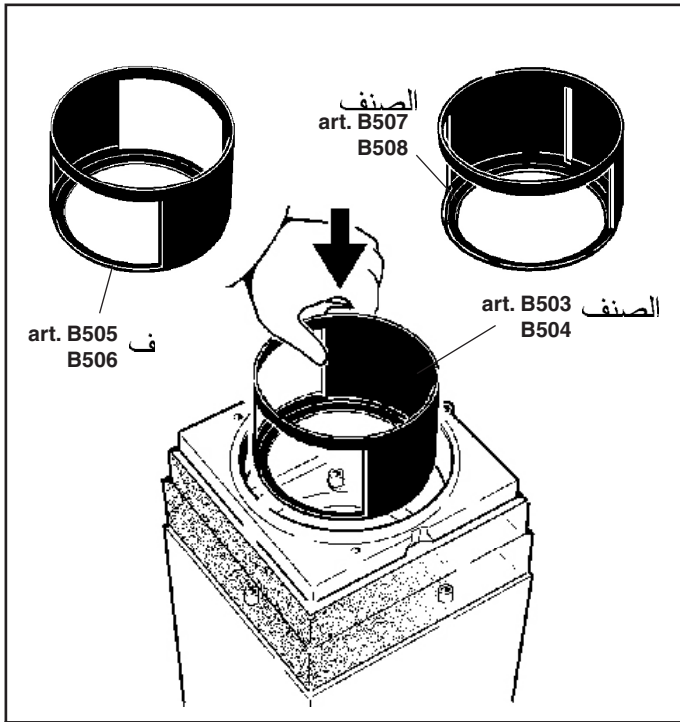

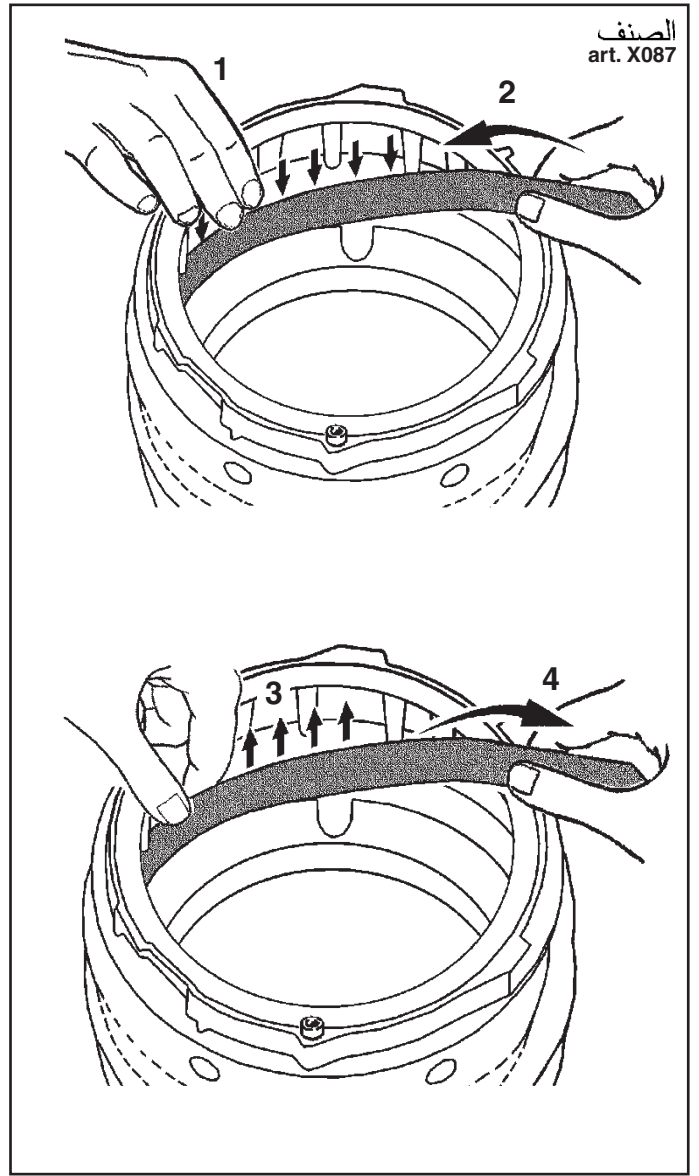
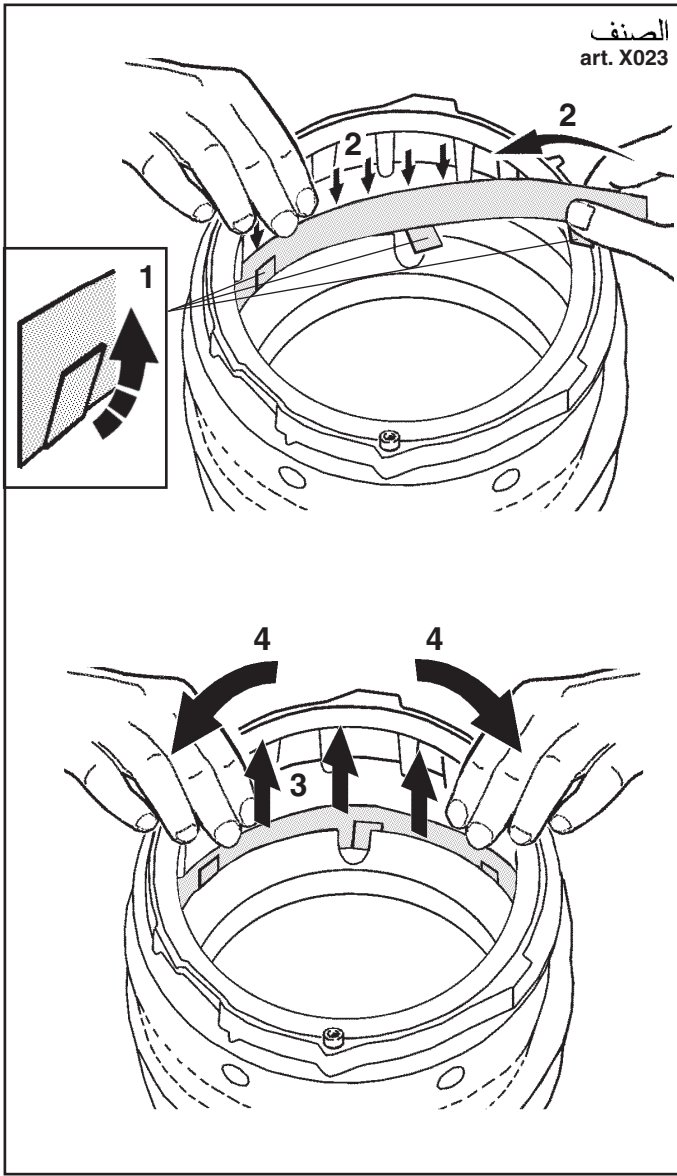

استبدال الضوء LED

SOSTITUZIONE DEL LED
REPLACING THE LED
REEMPLAZO DEL LED

تثبيته: لاستبدال الضوء LED اتصل بشركة iGuzzini . عر

I N.B.: Per la sostituzione del LED contattare l'azienda iGuzzini.

GB N.B.: For information on LED replacement please contact iGuzzini.

E NOTA: Para sustituir el LED llame a la empresa iGuzzini.

1.154.544.00

IS00766/05

SOSTITUZIONE DEL LED
REPLACING THE LED
REPLACEMENT DE LA LED
AUSTAUSCHEN DER LED
VERVANGEN VAN DE LED
REEMPLAZO DEL LED
UDSKIFTNING AF LYSDIODE
BYTE AV LYSDIOD
UTSKIFTING AV DEN LYSEMITTERENDE DIODEN
ЗАМЕНА СИДа
发光二极管替换

I N.B.: Per la sostituzione del LED contattare l'azienda iGuzzini.

GB N.B.: For information on LED replacement please contact iGuzzini.

F N.B.: Pour procéder au remplacement de la LED, adressez-vous à la société iGuzzini.

D N.B.: Bezüglich des Austausches der LED kontaktieren Sie bitte die Firma iGuzzini.

NL N.B.: Voor het vervangen van de LED neemt u contact op met het bedrijf iGuzzini.

E NOTA: Para sustituir el LED llame a la empresa iGuzzini.

DK N.B.: For udskiftning af lysdioden, skal man kontakte iGuzzini.

N N.B.: For informasjon om skifte av LED, vennligst ta kontakt med iGuzzini.

S OBS! För byte av lysdioden, kontakta företaget iGuzzini.

RUS ПРИМЕЧАНИЕ:Для замены СИДов обращайтесь в компанию iGuzzini.

CN 注意: 如需LED更换的信息, 请联系iGuzzini.

I Gruppo di rischio 1, secondo norma **EN 62471: 2008**
GB Risk Group: 1, in compliance with Standard **EN 62471: 2008**
FR Groupe de risque 1, suivant la norme **EN 62471 : 2008**
DE Risikogruppe 1, gemäß Vorschrift **EN 62471: 2008**
NL Risicogroep 1, volgens de norm **EN 62471: 2008**
E Grupo de riesgo 1, según norma **EN 62471: 2008**
DK Faregruppe 1 i henhold til standarden **EN 62471: 2008**
N Risikogruppe 1, i henhold til forskriften **EN 62471: 2008**
S Riskgrupp 1, enligt standard **EN 62471: 2008**
RUS GROUP РИСК 1 В СООТВЕТСТВИИ СО **EN 62471: 2008**

CN 风险组:1
灯具和灯具系统的光生物学安全性符合标准 **EN 62471: 2008**

iGuzzini

1.154.544.00

IS00766/05

SOSTITUZIONE DEL LED
REPLACING THE LED
REPLACEMENT DE LA LED
AUSTAUSCHEN DER LED
VERVANGEN VAN DE LED
REEMPLAZO DEL LED
UDSKIFTNING AF LYSDIODE
BYTE AV LYSDIOD
UTSKIFTING AV DEN LYSEMITTERENDE DIODEN
ЗАМЕНА СИДа
发光二极管替换

I N.B.: Per la sostituzione del LED contattare l'azienda iGuzzini.

GB N.B.: For information on LED replacement please contact iGuzzini.

F N.B.: Pour procéder au remplacement de la LED, adressez-vous à la société iGuzzini.

D N.B.: Bezüglich des Austausches der LED kontaktieren Sie bitte die Firma iGuzzini.

NL N.B.: Voor het vervangen van de LED neemt u contact op met het bedrijf iGuzzini.

E NOTA: Para sustituir el LED llame a la empresa iGuzzini.

DK N.B.: For udskiftning af lysdioden, skal man kontakte iGuzzini.

N N.B.: For informasjon om skifte av LED, vennligst ta kontakt med iGuzzini.

S OBS! För byte av lysdioden, kontakta företaget iGuzzini.

RUS ПРИМЕЧАНИЕ:Для замены СИДов обращайтесь в компанию iGuzzini.

CN 注意: 如需LED更换的信息, 请联系iGuzzini.

I Gruppo di rischio 1, secondo norma **EN 62471: 2008**
GB Risk Group: 1, in compliance with Standard **EN 62471: 2008**
FR Groupe de risque 1, suivant la norme **EN 62471 : 2008**
DE Risikogruppe 1, gemäß Vorschrift **EN 62471: 2008**
NL Risicogroep 1, volgens de norm **EN 62471: 2008**
E Grupo de riesgo 1, según norma **EN 62471: 2008**
DK Faregruppe 1 i henhold til standarden **EN 62471: 2008**
N Risikogruppe 1, i henhold til forskriften **EN 62471: 2008**
S Riskgrupp 1, enligt standard **EN 62471: 2008**
RUS GROUP РИСК 1 В СООТВЕТСТВИИ СО **EN 62471: 2008**

CN 风险组:1
灯具和灯具系统的光生物学安全性符合标准 **EN 62471: 2008**

iGuzzini

1.154.544.00

IS00766/05

SOSTITUZIONE DEL LED
REPLACING THE LED
REPLACEMENT DE LA LED
AUSTAUSCHEN DER LED
VERVANGEN VAN DE LED
REEMPLAZO DEL LED
UDSKIFTNING AF LYSDIODE
BYTE AV LYSDIOD
UTSKIFTING AV DEN LYSEMITTERENDE DIODEN
ЗАМЕНА СИДа
发光二极管替换

I N.B.: Per la sostituzione del LED contattare l'azienda iGuzzini.

GB N.B.: For information on LED replacement please contact iGuzzini.

F N.B.: Pour procéder au remplacement de la LED, adressez-vous à la société iGuzzini.

D N.B.: Bezüglich des Austausches der LED kontaktieren Sie bitte die Firma iGuzzini.

NL N.B.: Voor het vervangen van de LED neemt u contact op met het bedrijf iGuzzini.

E NOTA: Para sustituir el LED llame a la empresa iGuzzini.

DK N.B.: For udskiftning af lysdioden, skal man kontakte iGuzzini.

N N.B.: For informasjon om skifte av LED, vennligst ta kontakt med iGuzzini.

S OBS! För byte av lysdioden, kontakta företaget iGuzzini.

RUS ПРИМЕЧАНИЕ:Для замены СИДов обращайтесь в компанию iGuzzini.

CN 注意: 如需LED更换的信息, 请联系iGuzzini.

I Gruppo di rischio 1, secondo norma **EN 62471: 2008**
GB Risk Group: 1, in compliance with Standard **EN 62471: 2008**
FR Groupe de risque 1, suivant la norme **EN 62471 : 2008**
DE Risikogruppe 1, gemäß Vorschrift **EN 62471: 2008**
NL Risicogroep 1, volgens de norm **EN 62471: 2008**
E Grupo de riesgo 1, según norma **EN 62471: 2008**
DK Faregruppe 1 i henhold til standarden **EN 62471: 2008**
N Risikogruppe 1, i henhold til forskriften **EN 62471: 2008**
S Riskgrupp 1, enligt standard **EN 62471: 2008**
RUS GROUP РИСК 1 В СООТВЕТСТВИИ СО **EN 62471: 2008**

CN 风险组:1
灯具和灯具系统的光生物学安全性符合标准 **EN 62471: 2008**

iGuzzini

2.519.554.01 IS08596/01			iGuzini
ART.	fattore di potenza power factor facteur de puissance Leistungsfaktor vermogensfactor factor de potencia effektfaktor effektfaktor effektfaktor фактор мощности 功率因数	corrente assorbita absorbed current courant absorbé Stromaufnahme stroomopname corriente absorbida absorberet strøm absorbert strøm tillförd ström поглощаемая мощность 电源电流 (A)	
BW60 - BW61 - BW62 - BW63 BW64 - BW65 - BW66 - BW67 BW68 - BW69 - BW70 - BW71	0,90	0,06	
BW74 - BW75 - BW76 - BW77 BW78 - BW79 - BW80 - BW81 BW82 - BW83 - BW84 - BW85	0,86	0,29	

2.519.554.01 IS08596/01			iGuzini
ART.	fattore di potenza power factor facteur de puissance Leistungsfaktor vermogensfactor factor de potencia effektfaktor effektfaktor effektfaktor фактор мощности 功率因数	corrente assorbita absorbed current courant absorbé Stromaufnahme stroomopname corriente absorbida absorberet strøm absorbert strøm tillförd ström поглощаемая мощность 电源电流 (A)	
BW60 - BW61 - BW62 - BW63 BW64 - BW65 - BW66 - BW67 BW68 - BW69 - BW70 - BW71	0,90	0,06	
BW74 - BW75 - BW76 - BW77 BW78 - BW79 - BW80 - BW81 BW82 - BW83 - BW84 - BW85	0,86	0,29	

2.519.554.01 IS08596/01			iGuzini
ART.	fattore di potenza power factor facteur de puissance Leistungsfaktor vermogensfactor factor de potencia effektfaktor effektfaktor effektfaktor фактор мощности 功率因数	corrente assorbita absorbed current courant absorbé Stromaufnahme stroomopname corriente absorbida absorberet strøm absorbert strøm tillförd ström поглощаемая мощность 电源电流 (A)	
BW60 - BW61 - BW62 - BW63 BW64 - BW65 - BW66 - BW67 BW68 - BW69 - BW70 - BW71	0,90	0,06	
BW74 - BW75 - BW76 - BW77 BW78 - BW79 - BW80 - BW81 BW82 - BW83 - BW84 - BW85	0,86	0,29	

2.519.554.01 IS08596/01			iGuzini
ART.	fattore di potenza power factor facteur de puissance Leistungsfaktor vermogensfactor factor de potencia effektfaktor effektfaktor effektfaktor фактор мощности 功率因数	corrente assorbita absorbed current courant absorbé Stromaufnahme stroomopname corriente absorbida absorberet strøm absorbert strøm tillförd ström поглощаемая мощность 电源电流 (A)	
BW60 - BW61 - BW62 - BW63 BW64 - BW65 - BW66 - BW67 BW68 - BW69 - BW70 - BW71	0,90	0,06	
BW74 - BW75 - BW76 - BW77 BW78 - BW79 - BW80 - BW81 BW82 - BW83 - BW84 - BW85	0,86	0,29	

2.519.554.01 IS08596/01			iGuzini
ART.	fattore di potenza power factor facteur de puissance Leistungsfaktor vermogensfactor factor de potencia effektfaktor effektfaktor effektfaktor фактор мощности 功率因数	corrente assorbita absorbed current courant absorbé Stromaufnahme stroomopname corriente absorbida absorberet strøm absorbert strøm tillförd ström поглощаемая мощность 电源电流 (A)	
BW60 - BW61 - BW62 - BW63 BW64 - BW65 - BW66 - BW67 BW68 - BW69 - BW70 - BW71	0,90	0,06	
BW74 - BW75 - BW76 - BW77 BW78 - BW79 - BW80 - BW81 BW82 - BW83 - BW84 - BW85	0,86	0,29	

2.519.554.01 IS08596/01			iGuzini
ART.	fattore di potenza power factor facteur de puissance Leistungsfaktor vermogensfactor factor de potencia effektfaktor effektfaktor effektfaktor фактор мощности 功率因数	corrente assorbita absorbed current courant absorbé Stromaufnahme stroomopname corriente absorbida absorberet strøm absorbert strøm tillförd ström поглощаемая мощность 电源电流 (A)	
BW60 - BW61 - BW62 - BW63 BW64 - BW65 - BW66 - BW67 BW68 - BW69 - BW70 - BW71	0,90	0,06	
BW74 - BW75 - BW76 - BW77 BW78 - BW79 - BW80 - BW81 BW82 - BW83 - BW84 - BW85	0,86	0,29	

I PERIODO GIORNALIERO DI ACCENSIONE AMMESSO
GB ALLOWED DAILY OPERATION PERIOD
F DURÉE QUOTIDIENNE D'ALLUMAGE ADMISSIBLE
D ERLAUBTE TÄGLICHE EINSCHALTDAUER
NL DAGELIJKSE ONTSTEKINGSPERIODE TOEGESTAAN
E PERIODO DIARIO DE ENCENDIDO PERMITIDO
DK TILLADT TIDSRUM FOR DAGLIG TÆNDING
N TILLATT TENNINGSTID PR. DAG
S TILLÅTEN DAGLIG PERIOD SOM PRODUKTEN KAN VARA TÄND
RUS ЕЖЕДНЕВНАЯ ДОПУСТИМАЯ ПРОДОЛЖИТЕЛЬНОСТЬ РАБОТЫ
CN 允许的日常工作周期

iGuzzini

1.154.627.01
IS09175/01



I PERIODO GIORNALIERO DI ACCENSIONE AMMESSO
GB ALLOWED DAILY OPERATION PERIOD
F DURÉE QUOTIDIENNE D'ALLUMAGE ADMISSIBLE
D ERLAUBTE TÄGLICHE EINSCHALTDAUER
NL DAGELIJKSE ONTSTEKINGSPERIODE TOEGESTAAN
E PERIODO DIARIO DE ENCENDIDO PERMITIDO
DK TILLADT TIDSRUM FOR DAGLIG TÆNDING
N TILLATT TENNINGSTID PR. DAG
S TILLÅTEN DAGLIG PERIOD SOM PRODUKTEN KAN VARA TÄND
RUS ЕЖЕДНЕВНАЯ ДОПУСТИМАЯ ПРОДОЛЖИТЕЛЬНОСТЬ РАБОТЫ
CN 允许的日常工作周期

iGuzzini

1.154.627.01
IS09175/01



I PERIODO GIORNALIERO DI ACCENSIONE AMMESSO
GB ALLOWED DAILY OPERATION PERIOD
F DURÉE QUOTIDIENNE D'ALLUMAGE ADMISSIBLE
D ERLAUBTE TÄGLICHE EINSCHALTDAUER
NL DAGELIJKSE ONTSTEKINGSPERIODE TOEGESTAAN
E PERIODO DIARIO DE ENCENDIDO PERMITIDO
DK TILLADT TIDSRUM FOR DAGLIG TÆNDING
N TILLATT TENNINGSTID PR. DAG
S TILLÅTEN DAGLIG PERIOD SOM PRODUKTEN KAN VARA TÄND
RUS ЕЖЕДНЕВНАЯ ДОПУСТИМАЯ ПРОДОЛЖИТЕЛЬНОСТЬ РАБОТЫ
CN 允许的日常工作周期

iGuzzini

1.154.627.01
IS09175/01



I PERIODO GIORNALIERO DI ACCENSIONE AMMESSO
GB ALLOWED DAILY OPERATION PERIOD
F DURÉE QUOTIDIENNE D'ALLUMAGE ADMISSIBLE
D ERLAUBTE TÄGLICHE EINSCHALTDAUER
NL DAGELIJKSE ONTSTEKINGSPERIODE TOEGESTAAN
E PERIODO DIARIO DE ENCENDIDO PERMITIDO
DK TILLADT TIDSRUM FOR DAGLIG TÆNDING
N TILLATT TENNINGSTID PR. DAG
S TILLÅTEN DAGLIG PERIOD SOM PRODUKTEN KAN VARA TÄND
RUS ЕЖЕДНЕВНАЯ ДОПУСТИМАЯ ПРОДОЛЖИТЕЛЬНОСТЬ РАБОТЫ
CN 允许的日常工作周期

iGuzzini

1.154.627.01
IS09175/01



iGuzzini

2.509.386.00
ISO9176/01

الفترة الزمنية اليومية للتشغيل المسموح بها

- I PERIODO GIORNALIERO DI ACCENSIONE AMMESSO
- GB ALLOWED DAILY OPERATION PERIOD
- E PERIODO DIARIO DE ENCENDIDO PERMITIDO

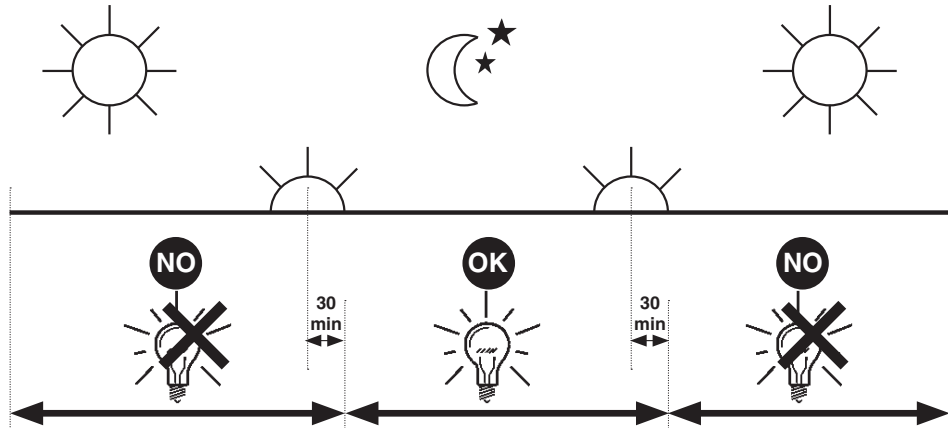

iGuzzini

2.509.386.00
ISO9176/01

الفترة الزمنية اليومية للتشغيل المسموح بها

- I PERIODO GIORNALIERO DI ACCENSIONE AMMESSO
- GB ALLOWED DAILY OPERATION PERIOD
- E PERIODO DIARIO DE ENCENDIDO PERMITIDO

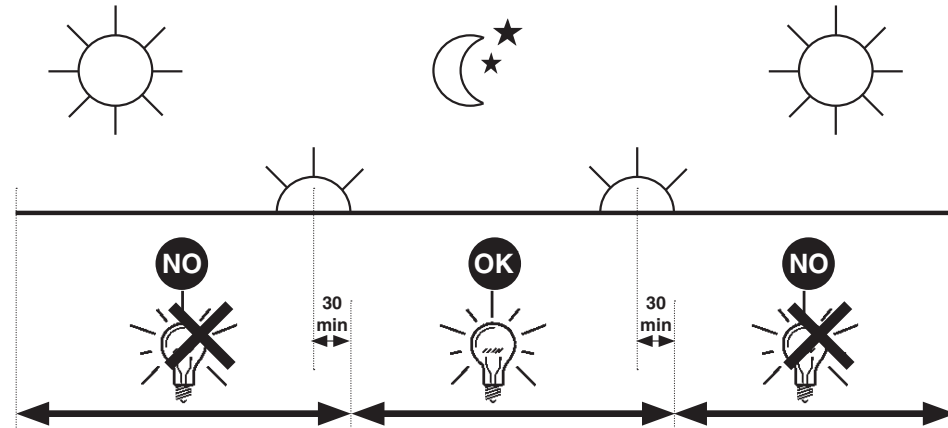

iGuzzini

2.509.386.00
ISO9176/01

الفترة الزمنية اليومية للتشغيل المسموح بها

- I PERIODO GIORNALIERO DI ACCENSIONE AMMESSO
- GB ALLOWED DAILY OPERATION PERIOD
- E PERIODO DIARIO DE ENCENDIDO PERMITIDO

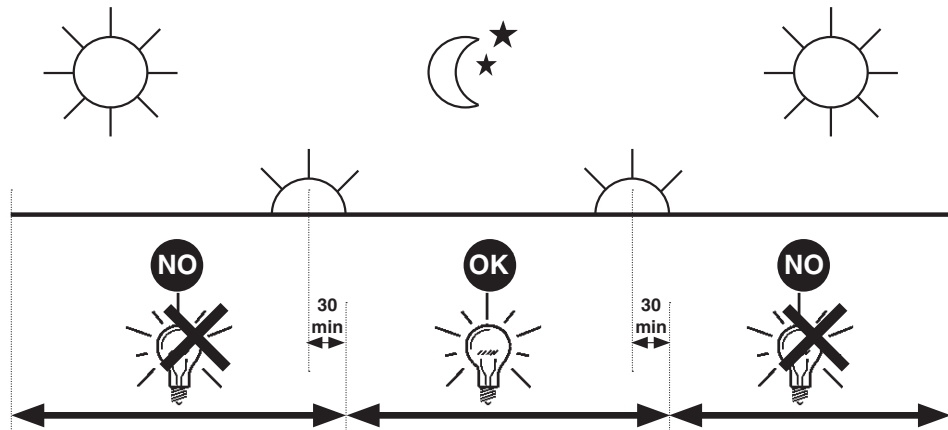

iGuzzini

2.509.386.00
ISO9176/01

الفترة الزمنية اليومية للتشغيل المسموح بها

- I PERIODO GIORNALIERO DI ACCENSIONE AMMESSO
- GB ALLOWED DAILY OPERATION PERIOD
- E PERIODO DIARIO DE ENCENDIDO PERMITIDO

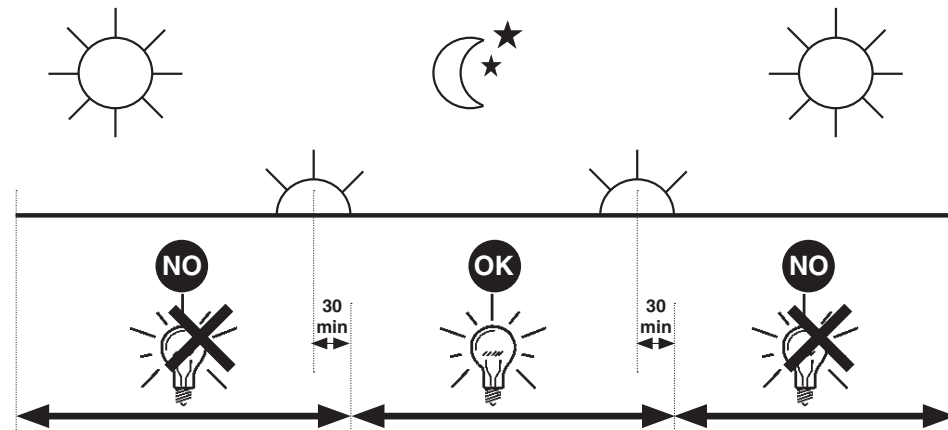

2.509.216.00
IS05718/01

استبدال الضوء LED
SOSTITUZIONE DEL LED
REPLACING THE LED
REEMPLAZO DEL LED

تنبیه: لاستبدال الضوء LED اتصل بشركة iGuzzini .

I N.B.: Per la sostituzione del LED contattare l'azienda iGuzzini.

GB N.B.: For information on LED replacement please contact iGuzzini.

E NOTA: Para sustituir el LED llame a la empresa iGuzzini.

فئة الخطر 1 . حسب مقاييس EN 62471: 2008 .

I Gruppo di rischio 1, secondo norma EN 62471: 2008

GB Risk Group: 1, in compliance with Standard EN 62471: 2008

E Grupo de riesgo 1, según norma EN 62471: 2008

iGuzzini

2.509.216.00
IS05718/01

استبدال الضوء LED
SOSTITUZIONE DEL LED
REPLACING THE LED
REEMPLAZO DEL LED

تنبیه: لاستبدال الضوء LED اتصل بشركة iGuzzini .

I N.B.: Per la sostituzione del LED contattare l'azienda iGuzzini.

GB N.B.: For information on LED replacement please contact iGuzzini.

E NOTA: Para sustituir el LED llame a la empresa iGuzzini.

فئة الخطر 1 . حسب مقاييس EN 62471: 2008 .

I Gruppo di rischio 1, secondo norma EN 62471: 2008

GB Risk Group: 1, in compliance with Standard EN 62471: 2008

E Grupo de riesgo 1, según norma EN 62471: 2008

iGuzzini

2.509.216.00
IS05718/01

استبدال الضوء LED
SOSTITUZIONE DEL LED
REPLACING THE LED
REEMPLAZO DEL LED

تنبیه: لاستبدال الضوء LED اتصل بشركة iGuzzini .

I N.B.: Per la sostituzione del LED contattare l'azienda iGuzzini.

GB N.B.: For information on LED replacement please contact iGuzzini.

E NOTA: Para sustituir el LED llame a la empresa iGuzzini.

فئة الخطر 1 . حسب مقاييس EN 62471: 2008 .

I Gruppo di rischio 1, secondo norma EN 62471: 2008

GB Risk Group: 1, in compliance with Standard EN 62471: 2008

E Grupo de riesgo 1, según norma EN 62471: 2008

iGuzzini

2.509.216.00
IS05718/01

استبدال الضوء LED
SOSTITUZIONE DEL LED
REPLACING THE LED
REEMPLAZO DEL LED

تنبیه: لاستبدال الضوء LED اتصل بشركة iGuzzini .

I N.B.: Per la sostituzione del LED contattare l'azienda iGuzzini.

GB N.B.: For information on LED replacement please contact iGuzzini.

E NOTA: Para sustituir el LED llame a la empresa iGuzzini.

فئة الخطر 1 . حسب مقاييس EN 62471: 2008 .

I Gruppo di rischio 1, secondo norma EN 62471: 2008

GB Risk Group: 1, in compliance with Standard EN 62471: 2008

E Grupo de riesgo 1, según norma EN 62471: 2008

iGuzzini

2.509.216.00
IS05718/01

استبدال الضوء LED
SOSTITUZIONE DEL LED
REPLACING THE LED
REEMPLAZO DEL LED

تنبیه: لاستبدال الضوء LED اتصل بشركة iGuzzini .

I N.B.: Per la sostituzione del LED contattare l'azienda iGuzzini.

GB N.B.: For information on LED replacement please contact iGuzzini.

E NOTA: Para sustituir el LED llame a la empresa iGuzzini.

فئة الخطر 1 . حسب مقاييس EN 62471: 2008 .

I Gruppo di rischio 1, secondo norma EN 62471: 2008

GB Risk Group: 1, in compliance with Standard EN 62471: 2008

E Grupo de riesgo 1, según norma EN 62471: 2008

iGuzzini

- I Istruzioni per le operazioni di servizio per l'apparecchio di illuminazione**
GB Instructions on luminaire service operations
F Instructions pour les opérations de service du luminaire
D Wartungsanleitung für die Leuchte
NL Instructies voor de onderhoudsoperaties op de verlichtingsarmatuur
E Instrucciones para las operaciones de servicio del aparato de alumbrado
DK Anvisninger i serviceindgreb på belysningsarmatur
N Anvisninger for betjening av lysapparatet
S Instruktioner för användning av belysningsanordningen
RUS Инструкция по эксплуатации осветительного прибора
CN 照明装置检修操作说明

Sostituire la lampada parzialmente esausta
 Replace the partly exhausted lamp
 Remplacer la lampe partiellement épuisée
 Die teilweise erschöpfte Lampe austauschen
 Vervang de gedeeltelijk lege lamp
 Sustituir la lámpara parzialmente agotada
 Udskift den delvist udtjente pære
 Skifte ut den delvis utbrente lyspæren
 Byt ut den delvis förbrukade lampan
 Замена частично отработанной лампочки
 更换部分老化的灯泡



Spegnimento
 Switch it off
 Extinction
 Ausschaltung
 Uitschakeling
 Apagado
 Slukning
 Slukking
 Släckning
 Выключение
 关灯

Interrompere l'alimentazione dell'apparecchio
 Cut the power supply to the luminaire
 Couper l'alimentation du luminaire
 Stromversorgung der Leuchte unterbrechen
 Onderbreek de voeding van het apparaat
 Interrumpir la alimentación del aparato
 Afbryd armaturets strømforsyning
 Avbryte strømtilførselen til apparatet
 Koppla från anordningens strömförsörjning
 Отключить электропитание прибора
 中断装置供电



Aprire l'apparecchio
 Open the fixture
 Ouvrir le luminaire
 Das Gerät öffnen
 Open het apparaat
 Abrir el aparato
 Åbn armaturet
 Åpne apparatet
 Öppna anordningen
 Раскрыть прибор
 打开装置

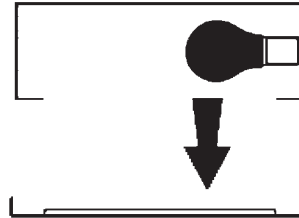

Rimuovere la lampada esausta
 Remove the exhausted lamp
 Retirer la lampe épuisée
 Die alte Lampe entnehmen
 Verwijder de lege lamp
 Quitar la lámpara agotada
 Tag den udtjente pære ud
 Fjerne den utbrente lyspæren
 Ta bort den förbrukade lampan
 Вынуть старую лампочку
 取出老化的灯泡

Portarla in un centro di riciclaggio
 Carry it to a recycling centre
 La porter dans une déchetterie pour son recyclage
 Ordnungsgemäß entsorgen
 Breng de lamp naar een recyclingcentrum
 Llevarla a un centro de reciclaje
 Aflever den på en genbrugsstation
 Lever den til en miljøstasjon
 Lämna in den till en återvinningsanläggning
 Сдать ее в пункт приема утильсырья
 将其送往回收中心



Inserire la nuova lampada
 Introduce the new lamp
 Installer la lampe neuve
 Die neue Lampe einsetzen
 Doe de nieuwe lamp op zijn plek
 Montar la nueva lámpara
 Sæt den nye pære i
 Sette i den nye pæren
 Sätt i den nya lampan
 Вставить новую лампочку
 装入新灯泡

Inserire la nuova lampada nel portalampada
 Fit the new lamp into the socket
 Installer la nouvelle lampe dans le support de lampe
 Die neue Lampe in den Sockel einsetzen
 Doe de nieuwe lamp in de lamphouder
 Montar la nueva lámpara en el portalámpara
 Sæt den nye pære i fatningen
 Sette den nye pæren inn i lampeholderen
 Sätt i den nya lampan i lamphållaren
 Вставить новую лампочку в патрон
 将新灯泡插入灯泡架中



Riposizionare ottica
 Re-place the optic
 Remettre l'optique à sa place
 Die Optik wieder einsetzen
 Doe de optiek weer op zijn plaats
 Volver a montar la óptica
 Sæt den optiske enhed på plads
 Innstille linsen
 Flytta om optiken
 Отрегулировать линзы
 重新定位光头



Effettuare prova di funzionamento
 Perform operative test
 Procéder à un essai de fonctionnement
 Eine Funktionsprüfung durchführen
 Controleer de correcte werking
 Hacer una prueba de funcionamiento
 Afprøv funktionen
 Prøve om den fungerer
 Utför funktionstest
 Выполнить проверку исправности работы
 执行功能测试



I Istruzioni per la pulizia dell'apparecchio di illuminazione
GB Instructions on luminaire cleaning operations
F Instructions pour le nettoyage du luminaire
D Anweisungen zur Reinigung der Leuchte
NL Instructies voor de reiniging van de verlichtingsarmatuur
E Instrucciones para limpiar el aparato de alumbrado
DK Anvisninger i rengøring af belysningsarmaturet
N Anvisninger for rengjøring av lysapparatet
S Instruktioner för rengöring av belysningsanordningen
RUS Инструкции по чистке осветительного прибора
CN 照明装置清洁说明

Pulire l'apparecchio
Clean the fixture
Nettoyer le luminaire
Das Gerät reinigen
Reinig het apparaat
Limpiar el aparato
Rengør armaturet
Rengjøre apparatet
Rengör anordningen
Чистка прибора
清洁装置

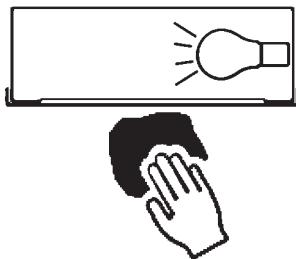

Spegnimento
Switch it off
Extinction
Ausschaltung
Uitschakeling
Apagado
Slukning
Slukking
Släckning
Выключение
关灯

Interrompere l'alimentazione dell'apparecchio
Cut the power supply to the luminaire
Couper l'alimentation du luminaire
Stromversorgung der Leuchte unterbrechen
Onderbreek de voeding van het apparaat
Interrumpir la alimentación del aparato
Afbryd armaturets strømforsyning
Avbryt strømtilførselen til apparatet
Koppla från anordningens strömförsörjning
Отключить электропитание прибора
中断装置供电



Spolverare l'ottica esterna
Remove dust from the external optic
Dépoussiérer l'optique extérieure
Die externe Optik abstauben
Stof de externe optiek af
Quitar el polvo de la óptica exterior
Tør støvet af den udvendige optiske enhed
Fjerne støv fra den eksterne lysenheden
Damma av den yttre optiken
Вытереть пыль с внешней стороны линз
为外侧光头掸尘

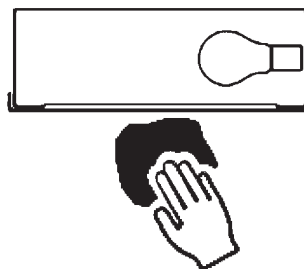

Lavare l'ottica esterna
Wash the external optic
Laver l'optique extérieure
Die externe Optik waschen
Was de externe optiek
Lavar la óptica exterior
Vask den udvendige optiske enhed
Vaske den eksterne lysenheden
Rengör den yttre optiken
Вымыть линзы с внешней стороны
清洁外光头



Rimuovere l'ottica
Remove the optic
Retirer l'optique
Die Optik abnehmen
Verwijder de optiek
Quitar la óptica
Tag den optiske enhed af
Fjerne lysenheden
Ta bort optiken
Снять линзы
取下光头



Pulire la parte interna dell'apparecchio di illuminazione
Clean the inside of the fixture
Nettoyer l'intérieur du luminaire
Die Innenseite der Leuchte reinigen
Reinig de binnenzijde van de verlichtingsarmatuur
Limpiar el interior del aparato de alumbrado
Rengør belysningsarmaturets indvendige dele
Rengjøre lysapparatet innvendig
Rengör belysningsanordningen invändigt
Протереть осветительный прибор изнутри
清洁照明装置内部

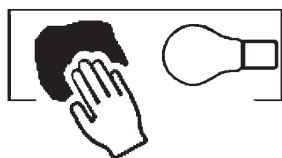

Riposizionare ottica
Re-place the optic
Remettre l'optique à sa place
Die Optik wieder einsetzen
Doe de optiek weer op zijn plaats
Volver a montar la óptica
Sæt den optiske enhed på plads
Innstille linsen
Flytta om optiken
Отрегулировать линзы
重新定位光头



Effettuare prova di funzionamento
Perform operative test
Procéder à un essai de fonctionnement
Eine Funktionsprüfung durchführen
Controleer de correcte werking
Hacer una prueba de funcionamiento
Afprøv funktionen
Prøve om den fungerer
Utför funktionstest
Выполнить проверку исправности работы
执行功能测试

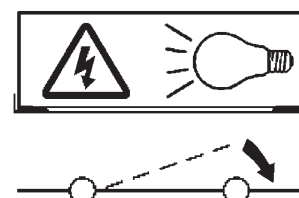

- I** Istruzioni per il fine vita e lo smaltimento dei componenti
GB Instructions on end-of-life and component disposal
F Instructions pour la gestion des composants en fin de vie et leur mise au rebut
D Anweisungen zur Entsorgung der Leuchtenkomponenten
NL Instructies voor het verwijderen van de armatuur en het recyclen van de onderdelen
E Instrucciones para el final de vida y la eliminación los componentes
DK Anvisninger i udtjent armatur og bortskaffelse af komponenter
N Anvisninger for endt levetid og avfallsbehandling av delene
S Instruktioner vid bortskaffning och kassering av komponenter
RUS Инструкции по утилизации прибора и его комплектующих по окончании его срока службы
CN 寿命期结束与零件废弃处置说明

<p>Spegnimento Switch it off Extinction Ausschaltung Uitschakeling Apagado Slukning Slukking Släckning Выключение 关灯</p> <p>Interrompere l'alimentazione dell'apparecchio Cut the power supply to the luminaire Couper l'alimentation du luminaire Stromversorgung der Leuchte unterbrechen Onderbreek de voeding van het apparaat Interrompirla alimentación del aparato Afbryd armaturets strømforsyning Avbryt strømtilførselen til apparatet Koppla från anordningens strömförsörjning Отключить электропитание прибора 中断装置供电</p> 	<p>Rimuovere la/e lampada/e per la dismissione Remove the lamp(s) for decommissioning Retirer la(les) lampe(s) pour sa(leur) mise au rebut Die Lampe/n ordnungsgemäß entsorgen Verwijder de lamp(en) voor het recyclen Quitar la(s) lámpara(s) para el desecho Tag pæren/pærerne ud til bortskaffelse Fjerne lampen/-e som skal kastes Ta bort lampan/-orna för bortskaffningen Вынуть лампочку/и для утилизации прибора 取出需要丢弃的灯泡</p> 	<p>Rimuovere la batteria per la dismissione Remove the battery for decommissioning Retirer la batterie pour sa mise au rebut Die Batterie ordnungsgemäß entsorgen Verwijder de batterij voor het recyclen Quitar la batería para el desecho Tag batteriet ud til bortskaffelse Fjerne batteriet som skal kastes Ta bort batteriet för bortskaffningen Вынуть батарейку для утилизации прибора 取出需要丢弃的电池</p> 	<p>Rimuovere l'apparecchio per la dismissione Remove the fixture for decommissioning Enlever le luminaire pour sa mise au rebut Das Gerät ordnungsgemäß entsorgen Verwijder het apparaat voor het recyclen Quitar el aparato para el desecho Tag armaturet ud til bortskaffelse Fjerne apparatet som skal kastes Ta bort anordningen för bortskaffningen Снять прибор для утилизации 取出需要丢弃的装置</p> 
---	--	--	--

<p>Inviare i materiali ad un centro di raccolta RAEE Send the materials to a WEEE collection centre Envoyer les matériaux dans une déchetterie DEEE Die Materialien in einem WEEE-Zentrum entsorgen Zend de materialen naar een recyclingscentrum voor de AEEA Enviar los materiales a un centro de recogida RAEE Afløver materialerne på et indsamlingscenter for elektronisk udstyr Sende materialene til en miljøstasjon for resirkulering av EE-avfall Skicka materialet till en RAEE uppsamlingscentral Сдать материалы в пункт приема утильсырья 将材料送往电气和电子垃圾回收中心</p> 			
--	--	--	--