

## iWAY

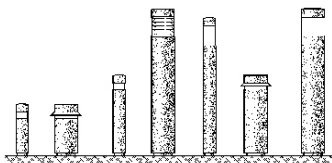

POSIZIONE D'INSTALLAZIONE  
INSTALLATION POSITION  
POSITION D'INSTALLATION  
INSTALLATIONSPOSITION  
INSTALLERINGPOSITIE  
POSICION DE INSTALACION  
INSTALLATIONSPOSITION  
INSTALLATIONSPOSITION  
INSTALLATIONSPOSITION  
INSTALLATIONSPOSITION  
MONTAJNOE POLOZHENIE  
安裝位置

Pag. 1

INTERASSI DI FORATURA  
CENTRE TO CENTRE DISTANCE BETWEEN HOLES  
ENTRE-AXES DE PERCAGE  
ABSTAND DER BOHRLÖCHER  
AFSTANDEN TUSSEN DE GATEN  
DISTANCIA ENTRE LOS EJES DE PERFORACIÓN  
HULAFSTAND  
AVSTANDER FRA SENTER TIL SENTER MELLOM HULL  
AVSTÅND MELLAN HÅL  
ШАГ ОТВЕРСТИЙ  
孔间的中心距离

Pag. 2

CABLAGGIO ELETTRICO  
ELECTRIC WIRING  
CABLAGE ÉLECTRIQUE  
ELEKTRISCHE VERKABELUNG  
DE ELEKTRISCHE INSTALLERING  
CABLAJE ELÉCTRICOELEKTRISK LEDNINGSFØRING  
ELEKTRISK KABELING  
ELEKTRISK KABELDRAGNING  
МОНТАЖ КАБЕЛЬНОЙ ПРОВОДКИ  
布线

Pag. 3

INSTALLAZIONE E SOSTITUZIONE DELLA LAMPADA  
INSTALLING AND REPLACING THE LAMP  
INSTALLATION ET REMPLACEMENT DE LA LAMPE  
EINSETZEN UND AUSTAUSCHEN DER LEUCHE  
HET INSTALLEREN EN VERVANGEN VAN DE LAMP  
INSTALACIÓN Y REEMPLAZO DEL FOCO  
INSTALLATION OG UDSKIFTNING AF LYSKILDEN  
INSTALLERE OG SKIFTE LAMPEN  
INSTALLATION OCH BYTE AV LAMPA  
МОНТАЖ И ЗАМЕНА ЛАМПА  
安裝和更換光源

Pag. 8

INSTALLAZIONE E SOSTITUZIONE DEL VETRO DI PROTEZIONE  
INSTALLING AND REPLACING THE PROTECTION GLASS  
INSTALLATION ET REMPLACEMENT DU VERRE DE PROTECTION  
INSTALLATION UND AUSWECHSELN DES SCHUTZGLASES  
HET INSTALLEREN EN VERVANGEN VAN HET PROTEKTIEGLAS  
INSTALACIÓN Y REEMPLAZO DEL CRISTAL DE PROTECCION  
INSTALLATION OG UDSKIFTNING AF BESKYTTELSESGLAS  
INSTALLERE OG SKIFTE UT BESKYTTELSESGLASSET  
INSTALLATION OCH BYTE AV SKYDDSGLAS  
УСТАНОВКА И ЗАМЕНА ЗАЩИТНОГО СТЕКЛА  
防护玻璃的安装与拆卸

Pag. 10

INSTALLAZIONE DEGLI ACCESSORI  
INSTALLING THE ACCESSORIES  
INSTALLATION DES ACCESSOIRES  
INSTALLATION DER ZUBEHÖRTEILE  
HET INSTALLEREN VAN DE ACCESSOIRES  
INSTALACION DE ACCESORIOS  
INSTALLATION AF TILBEHØR  
INSTALLERING AV TILBEHØRET  
INSTALLATION AV TILLBEHÖR  
МОНТАЖ ВСПОМОГАТЕЛЬНЫХ КОМПЛЕКТУЮЩИХ  
配件安装

Pag. 10

**ATTENZIONE:**  
LA SICUREZZA DELL'APPARECCHIO E' GARANTITA SOLO CON L'USO APPROPRIATO DELLE SEGUENTI ISTRUZIONI; PERTANTO E' NECESSARIO CONSERVARLE.

**WARNING:**  
THE SAFETY OF THIS FIXTURE IS GUARANTEED ONLY IF YOU COMPLY WITH THESE INSTRUCTIONS; REMEMBER TO CONSERVE IN A SAFE PLACE.

**ATTENTION:**  
LA SECURITE DE L'APPAREIL N'EST GARANTIE QU'EN CAS D'UTILISATION CORRECTE DES INSTRUCTIONS SUIVANTES; IL FAUT PAR CONSEQUENT LES CONSERVER.

**ACHTUNG:**  
DIE SICHERHEIT DES GERÄTES WIRD NUR DURCH SACHGEMÄSSE BEFOLGUNG NACHSTEHENDER ANWEISUNGEN GEWÄHRLEISTET; IHRE AUFBEWAHRUNG IST DESHALB SEHR WICHTIG.

**OPGELET:**  
DE VEILIGHEID VAN DI ATOESTEL IS SLECHTS DAN GEGARANDEERD ALS INDIEN DE VOLGENDE INSTRUC-TIES STRIKT WORDEN TOEGEPAST; DAAROM MOET MEN ZE OOK BEWAREN.

**ATENCIÓN:**  
LA SEGURIDAD DEL APARATO SE GARANTIZA SOLO CUMPLIENDO CUIDADOSAMENTE LAS SIGUIENTES INSTRUCCIONES; POR ELLO, ES NECESARIO CONSERVARLAS.

**BEMÆRK:**  
SIKKERHEDEN VED BRUG AF ARMATURET KAN KUN GARANTERES, HVIS DISSE ANVISNINGER FØLGES; SØRG DERFOR FOR AT GEMME DEM.

**ADVARSEL:**  
SIKKERHETENTIL DETTE APPARATET GARANTERES KUN HVIS DU OVERHOLDER DISSE INSTRUKSJONENE; HUSK Å OPPBEVARE DEM PÅ ET TRYGT STED.

**OBSERVERA!**  
UTRUSTNINGENS SÄKERHET KAN ENDAST GARANTERAS OM DESSA ANVISNINGAR RESPEKTERAS I DETALJ. SPARA DÄRFÖR DESSA ANVISNINGAR FÖR FRAMTIDA KONSULTATION.

ВНИМАНИЕ:  
МЫ ГАРАНТИРУЕМ БЕЗОПАСНУЮ ЭКСПЛУАТАЦИЮ ИЗДЕЛИЯ ТОЛЬКО ПРИ СОБЛЮДЕНИИ СЛЕДУЮЩИХ ИНСТРУКЦИЙ; С ЭТОЙ ЦЕЛЬЮ НЕОБХОДИМО СОХРАНИТЬ ДАННУЮ БРОШЮРУ.

警告  
为确保该装置安全，请遵守操作指示；并于安全场所放置。

N.B.: DURANTE L'INSTALLAZIONE DEL SISTEMA "iWAY" RISPETTARE SCRUPOLOSAMENTE LE NORME IMPIANTISTICHE NAZIONALI VIGENTI.

N.B.: WHEN INSTALLING THE "iWAY" SYSTEM, MAKE SURE ALL CURRENT NATIONAL REGULATIONS RELATING TO INSTALLATION ARE OBSERVED.

N.B.: LORS DE L'INSTALLATION DU SYSTÈME "iWAY" VEUILLEZ RESPECTER RIGOREUSEMENT LES NORMES EN VIGUEUR EN LA MATIÈRE DANS LE PAYS.

N.B.: BEACHTEN SIE BEI DER INSTALLATION DES SYSTEMS "iWAY" UNBEDINGT DIE IM LAND GELTENDEN ANLAGETECHNISCHEN VORSCHRIFTEN.

N.B.: BIJ HET INSTALLEREN VAN HET "iWAY" SYSTEEM MOET U DE GELDENDE NATIONALE INSTALLATIENORMEN STRIKT NALEVEN.

NOTA: DURANTE LA INSTALACIÓN DEL SISTEMA "iWAY" RESPETAR ESCRUPULOSAMENTE LAS NORMAS NACIONALES DE INSTALACIÓN EN VIGOR.

N.B.: UNDER INSTALLATION AF "iWAY" SYSTEMET SKAL MAN NØJE OVERHOLDE DE GÆLDENDE REGLER FOR DISSE ANLÆG.

N.B.: UNDER INSTALLASJON AV SYSTEMET "iWAY" MÅ DEN NASJONALE ANLEGGSFORSKRIF-TENE OVERHOLDES NØYE.

OBS! UNDER INSTALLATIONEN AV SYSTEMET "iWAY" SKA GÄLLANDE NATIONELLA IN-STALLATIONSFÖRESKRIFTER RESPEKTERAS I DETALJ.

ПРИМЕЧАНИЕ: В ПРОЦЕССЕ МОНТАЖА СИСТЕМЫ "iWAY" СТРОГО СОБЛЮДАЙТЕ НАЦИОНАЛЬНЫЕ ДЕЙСТВУЮЩИЕ НОРМАТИВЫ ПО ЭЛЕКТРОПРОВОДКЕ.

注意：安装 "iWAY" 系统时请务必遵守系统标准。

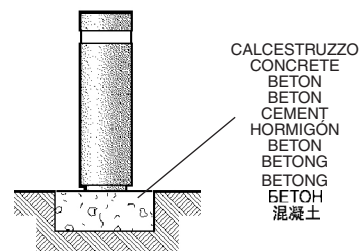
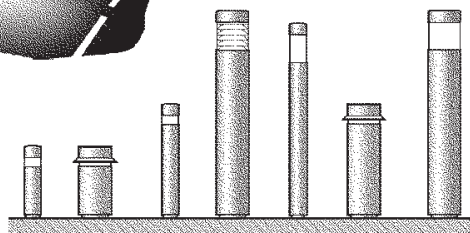
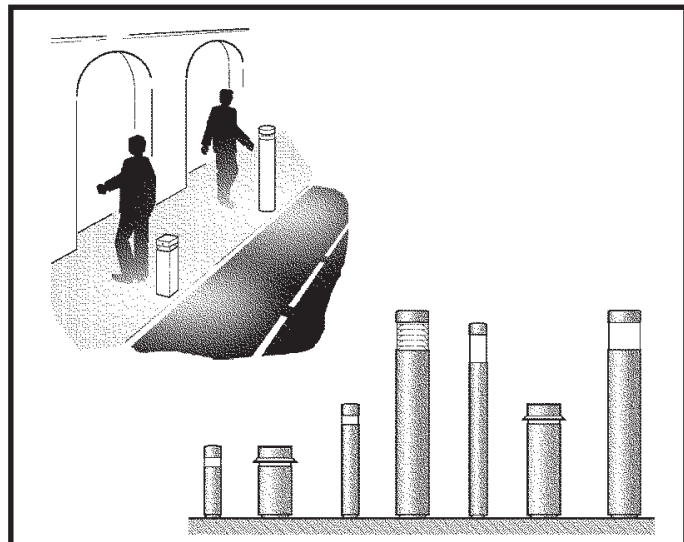
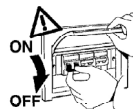

CALCESTRUZZO  
CONCRETE  
BETON  
CEMENT  
HORMIGÓN  
BETON  
BETONG  
BETONG  
BETON  
混凝土

I N.B.: Installando l'apparecchio, evitare che la base venga interrata o posizionata in punti soggetti al ristagno dell'acqua.

GB N.B.: Whilst installing the appliance, avoid concealing its base or placing it in areas which are susceptible to damp.

F N.B.: Lors de l'installation de l'appareil, veillez à ce que la base ne soit pas enterrée ou positionnée dans un endroit sujet à la stagnation de l'eau.

D N.B.: Bei der Installation des Gerätes ist darauf zu achten, daß das Unterteil nicht eingegraben oder an Stellen placiert wird, an denen sich Wasser stauen könnte.

NL N.B.: Het apparaat mag niet met de basis ingebouwd worden of op punten geïnstalleerd die stilstaand water veroorzaken.

E NOTA: Al instalar el aparato, evite que la base se entierre o se coloque en puntos donde se pueda estancar el agua.

DK N.B.: Ved installation af armaturet skal man undgå, at soklen er under niveau eller placeres på et sted, hvor der ophobes vand.

N N.B.: Under installasjon av apparatet, unngå å skjule basen eller plassere den på områder som er utsatt for damp.

S OBS! När utrustningen installeras ska du undvika att basen hamnar under marken eller placeras på ställen där vatten ansamlas.

RUS ПРИМЕЧАНИЕ: При монтаже прибора следует избегать зарывания в почву или установки его основания в местах, подверженных затоплению.

CN 注意：安装该灯具时，避免隐藏底座或将灯具放置在易受潮的区域。

art. B461  
B462 - B463 - B464  
B465 - B466 - B467  
B473 - B474 - B475  
B476 - B477 - B478  
B633 - B634 - B635  
B636 - B637 - B638  
BG25 - BG29 - BG23  
BG24 - MR81 - MR82  
MR83 - MR84 - BW60  
BW61 - BW62 - BW63  
BW64 - BW65 - BW74  
BW75 - BW76 - BW77  
BW78 - BW79

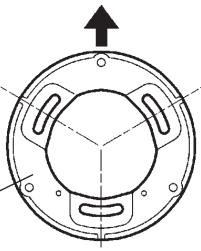

LATO PEDONALE O CARRABILE  
PEDESTRIAN OR VEHICULAR SIDE  
CÔTÉ PIÉTONS OU VOITURES  
FUSSGÄNGER- ODER FAHRWEGSEITE  
VOETGANGERSZIJDE OF BERIJDBARE ZIJDE  
LADO PEATONAL O VEHICULAR  
GANGSTI ELLER KØREBANE  
FOTGJENGER- ELLER KØRETØYSIDE  
SIDA FØR FOTGÅNGARE ELLER FORDON  
ПЕШЕХОДНАЯ ИЛИ ПРОЕЗЖАЯ СТОРОНА  
行人或机动车侧

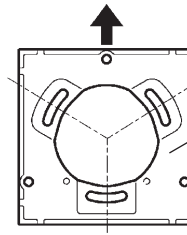

art. B481  
B482 - B483 - B484  
B485 - B486 - B487  
B641 - B642 - B643  
B644 - B645 - B646  
BG28 - BG30 - BG26  
BG27 - MR85 - MR86  
MR87 - MR88 - BW66  
BW67 - BW68 - BW69  
BW70 - BW71 - BW80  
BW81 - BW82 - BW83  
BW84 - BW85

PER IL FISSAGGIO SI CONSIGLIA DI UTILIZZARE TASSELLI PER ANCORAGGI PESANTI TIPO FZA- I- M 8 FISCHER, O SIMILARI ANCHE DI ALTRI COSTRUTTORI.

FOR FIXING USE HEAVY DUTY PLUGS, SUCH AS FZA- I- M 8 FISCHER OR SIMILAR, INCLUDING FROM OTHER MANUFACTURERS.

POUR LA FIXATION, IL EST CONSEILLÉ D'UTILISER DES CHEVILLES POUR ANCRAGES LOURDS DE TYPE FZA- I- M 8 FISCHER OU SIMILAIRES (D'AUTRES FABRICANTS AUSSI).

ZUR BEFESTIGUNG EMPFEHLEN WIR, STARKE VERANKERUNGSDÜBEL ZU VERWENDEN, ZUM BEISPIEL VOM TYP FZA- I- M 8 VON FISCHER ODER ENTSPRECHENDE PRODUKTE VON ANDEREN HERSTELLERN.

VOOR DE BEVESTIGING RADEN WIJ U AAN PLUGGEN VOOR ZWARE VERANKERINGEN TE GEBRUIKEN, ZOALS HET TYPE FZA- I- M 8 FISCHER OF DERGELIJKE, OOK VAN ANDERE PRODUCTENTEN.

PARA LA FIJACIÓN SE RECOMIENDA UTILIZAR TACOS PARA ANCLAJES DE GRAN RESISTENCIA, TIPO FZA- I- M 8 FISCHER, O SIMILARES, INCLUIDO DE OTROS FABRICANTES.

VED MONTERING ANBEFALES BRUG AF RAWLPLUGS TIL TUNGE EMNER AF TYPEN FZA- I- M 8 FISCHER, ELLER LIGNENDE FRA ANDRE FABRIKANTER.

FOR FESTE BRUKES HØYTYTELSE PLUGGER, SLIK SOM FZA- I- M 8 FISCHER ELLER LIGNENDE, INKLUDERT FRA ANDRE PRODUSENTER.

FÖR FASTSÄTTNINGEN REKOMMENDERAS ATT ANVÄNDA PLUGGAR FÖR FASTSÄTTNING AV TYNGRE FÖREMÅL AV TYP FZA- I- M 8 FISCHER, ELLER LIKNANDE AV ANNAT MÄRKE.

ДЛЯ КРЕПЛЕНИЯ РЕКОМЕНДУЕТСЯ ИСПОЛЬЗОВАТЬ ВКЛАДЫШИ ДЛЯ ТЯЖЕЛОГО КРЕПЛЕНИЯ ТИПА FZA- I- M 8 FISCHER ИЛИ ПОДОБНЫЕ ДРУГИХ МАРК.

进行固定时，使用大载流插头，例如 FZA- I- M 8 FISCHER 或 SIMILAR，也包括其他生产商提供的插头。

INSTALLAZIONE CON L'ART. B513 - INSTALLATION WITH ART. B513  
INSTALLATION AVEC L'ART. B513 - MONTAGE MIT ART. B513  
HET INSTALLEREN MET ART. B513 - INSTALACION CON ART. B513  
МОНТАЖ С ИЗДЕЛИЕМ B513 安装 ART. B513

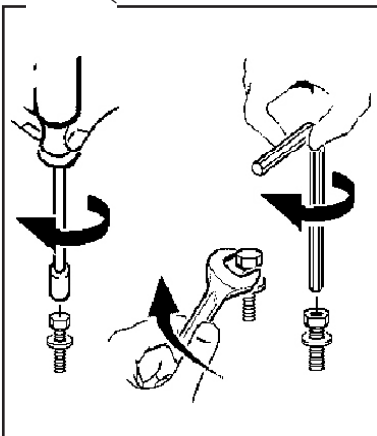
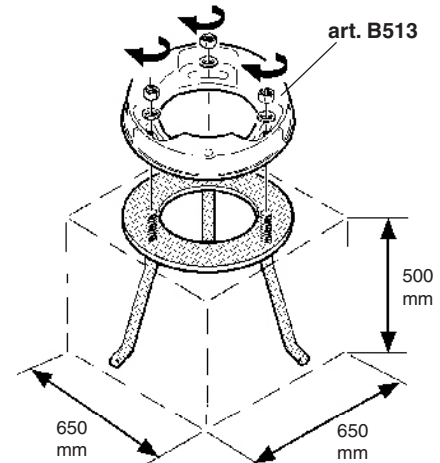
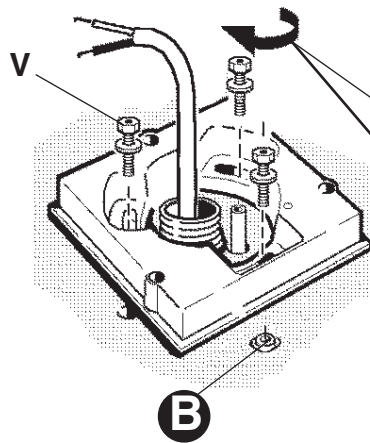
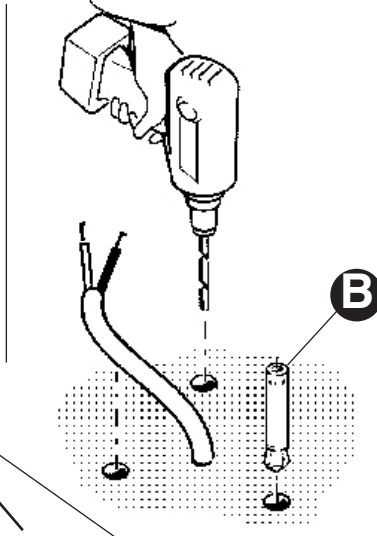
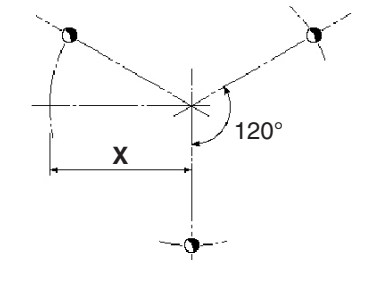
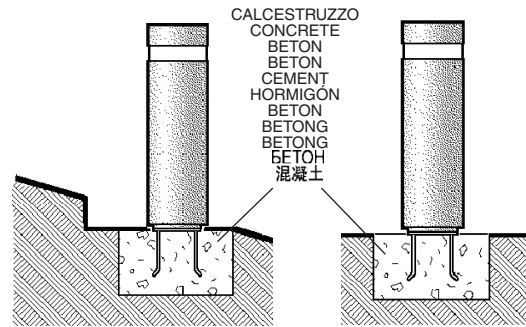

ART.	X (mm)	V (mm)	art.
B461 - B462 - B463 - B464 - B465 B466 - B467 - B474 - B473 - B475 B476 - B477 - B478 - B481 - B482 B483 - B484 - B485 - B486 - B487 B633 - B634 - B635 - B636 - B637 B638 - B641 - B642 - B643 - B644 B645 - B646 - BG23 - BG24 - BG25 BG28 - BG26 - BG27 - BG29 - BG30 MR81 - MR82 - MR83 - MR84 - MR85 MR86 - MR87 - MR88 - BW60 - BW61 BW62 - BW63 - BW64 - BW65 - BW74 BW75 - BW76 - BW77 - BW78 - BW79 BW66 - BW67 - BW68 - BW69 - BW70 BW71 - BW80 - BW81 - BW82 - BW83 BW84 - BW85	56	M 8	B513

I N.B.: Le dimensioni del Plinto sono fornite a titolo indicativo, sono state calcolate considerando un terreno con pressione ammissibile di 1,0bar (1,0 kg /cm<sup>2</sup>)  
GB N.B.: The dimensions of the plinth are purely indicative and were calculated taking into account a surface with an allowable pressure of 1.0 bar (1.0 kg/cm<sup>2</sup>)  
F N.B.: Les dimensions du massif de fondation sont fournies à titre indicatif et ont été calculées en tenant compte d'un sol dont la pression admise est égale à 1,0 bar (1,0 kg /cm<sup>2</sup>)  
D N.B.: Die Abmessungen der Plinthe sind als Richtwert angegeben und wurden für ein Gelände mit zulässigem Druck von 1,0 bar (1,0 kg /cm<sup>2</sup>) berechnet  
NL N.B.: De afmetingen van Plinto zijn slechts als voorbeeld verschaft. Zij zijn berekend op basis van een bodem met een toegestane druk van 1,0 bar (1,0 kg/cm<sup>2</sup>).  
E NOTA: Las medidas de Plinto son sólo indicativas, han sido calculadas considerando un terreno con presión admisible de 1,0bar (1,0 kg /cm<sup>2</sup>)  
DK N.B.: Dimensionerne på Plinto er omtrentlige. De er beregnet ud fra et maks. tilladt jordtryk på 1,0 bar (1,0 kg /cm<sup>2</sup>)  
N N.B.: Størrelsen på pilaren gis kun som et eksempel, den er utregnet på grunnlag av et terreng med et tillatt trykk på 1,0 bar (1,0 kg /cm<sup>2</sup>)  
S OBS! Måtten som anges för Plinto är endast ungefärliga och har beräknats på en mark med ett tillåtet tryck på 1,0 bar (1,0 kg /cm<sup>2</sup>)  
RUS ПРИМЕЧАНИЕ: Размеры Plinto, приведенные только в качестве примера, были рассчитаны с учетом почвы с допустимым давлением 1,0 бар (1,0 кг/см<sup>2</sup>)  
CN 注意：底座的外形尺寸完全是参考性的并且表面的容许压力1.0 bar (1.0 kg/cm<sup>2</sup>)要被计算考虑在内。

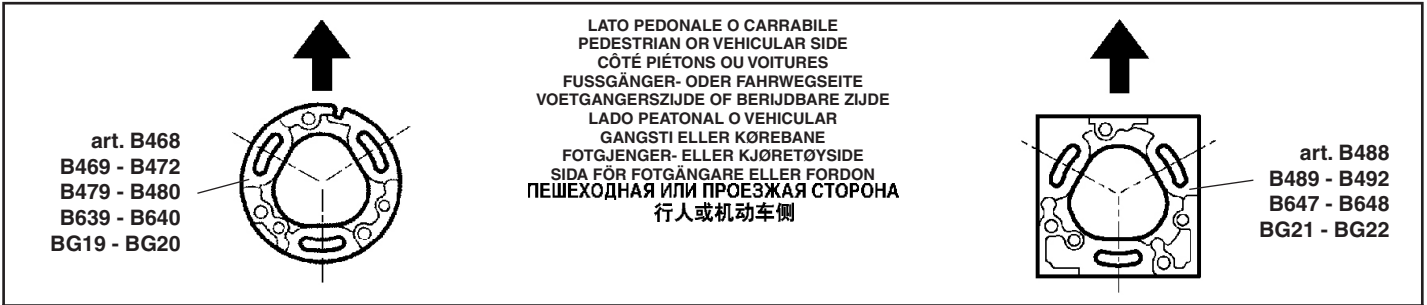

art. B468  
B469 - B472  
B479 - B480  
B639 - B640  
BG19 - BG20

LATO PEDONALE O CARRABILE  
PEDESTRIAN OR VEHICULAR SIDE  
CÔTÉ PIÉTONS OU VOITURES  
FUSSGÄNGER- ODER FAHRWEGSEITE  
VOETGANGERSZIJDE OF BERIJDBARE ZIJDE  
LADO PEATONAL O VEHICULAR  
GANGSTI ELLER KJØREBANE  
FOTGJENGER- ELLER KJØRETOYSIDE  
SIDA FÖR FOTGÅNGARE ELLER FORDON  
ПЕШЕХОДНАЯ ИЛИ ПРОЕЗЖАЯ СТОРОНА  
行人或机动车侧

art. B488  
B489 - B492  
B647 - B648  
BG21 - BG22

PER IL FISSAGGIO SI CONSIGLIA DI UTILIZZARE TASSELLI PER ANCORAGGI PESANTI TIPO **FZA- I- M 6** FISCHER, O SIMILARI ANCHE DI ALTRI COSTRUTTORI.

FOR FIXING USE HEAVY DUTY PLUGS, SUCH AS **FZA- I- M 6** FISCHER OR SIMILAR, INCLUDING FROM OTHER MANUFACTURERS.

POUR LA FIXATION, IL EST CONSEILLÉ D'UTILISER DES CHEVILLES POUR ANCRAGES LOURDS DE TYPE **FZA- I- M 6** FISCHER OU SIMILAIRES (D'AUTRES FABRICANTS AUSSI).

ZUR BEFESTIGUNG EMPFEHLEN WIR, STARKE VERANKERUNGSDÜBEL ZU VERWENDEN, ZUM BEISPIEL VOM TYP **FZA- I- M 6** VON FISCHER ODER ENTSPRECHENDE PRODUKTE VON ANDEREN HERSTELLERN.

VOOR DE BEVESTIGING RADEN WIJ U AAN PLUGGEN VOOR ZWARE VERANKERINGEN TE GEBRUIKEN, ZOALS HET TYPE **FZA- I- M 6** FISCHER OF DERGELIJKE, OOK VAN ANDERE PRODUCTEN.

PARA LA FIJACIÓN SE RECOMIENDA UTILIZAR TACOS PARA ANCLAJES DE GRAN RESISTENCIA, TIPO **FZA- I- M 6** FISCHER, O SIMILARES, INCLUSO DE OTROS FABRICANTES.

VED MONTERING ANBEFALES BRUG AF RAWLPLUGS TIL TUNGE EMNER AF TYPEN **FZA- I- M 6** FISCHER, ELLER LIGNENDE FRA ANDRE FABRIKANTER.

FOR FESTE BRUKES HØYTTELSESLUGGER, SLIK SOM **FZA- I- M 6** FISCHER ELLER LIGNENDE, INKLUDERT FRA ANDRE PRODUSENTER.

FÖR FASTSÄTTNINGEN REKOMMENDAS ATT ANVÄNDA PLUGGAR FÖR FASTSÄTTNING AV TYNGRE FÖREMÅL AV TYP **FZA- I- M 6** FISCHER, ELLER LIKNANDE AV ANNAT MÄRKE.

ДЛЯ КРЕПЛЕНИЯ РЕКОМЕНДУЕТСЯ ИСПОЛЬЗОВАТЬ ВКЛАДЫШИ ДЛЯ ТЯЖЕЛОГО КРЕПЛЕНИЯ ТИПА **FZA- I- M 6** FISCHER ИЛИ ПОДОБНЫЕ ДРУГИХ МАРОК.

进行固定时，使用大载流插头，例如 **FZA- I- M 6** FISCHER 或 SIMILAR，也包括其他生产商提供的插头。

INSTALLAZIONE CON L'ART. B514 - INSTALLATION WITH ART. B514  
INSTALLATION AVEC L'ART. B514 - MONTAGE MIT ART. B514  
HET INSTALLEREN MET ART. B514 - INSTALACION CON ART. B514  
МОНТАЖ С ИЗДЕЛИЕМ B514 安装ART. B514

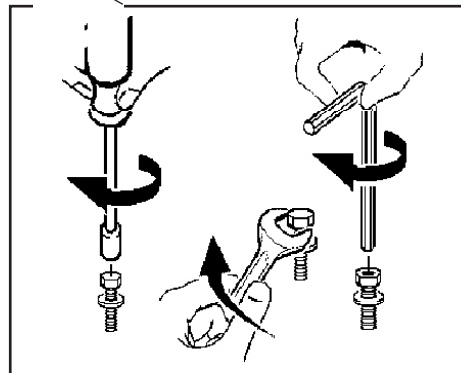
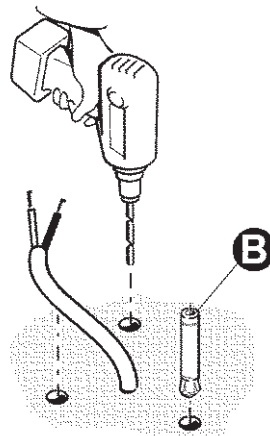
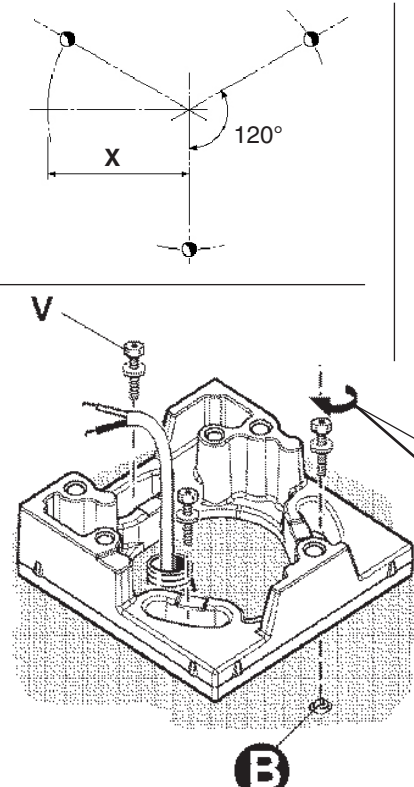
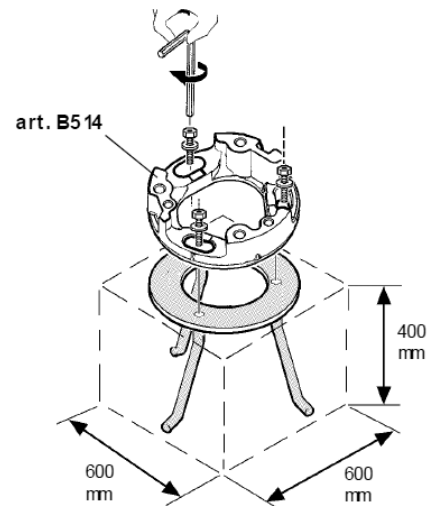
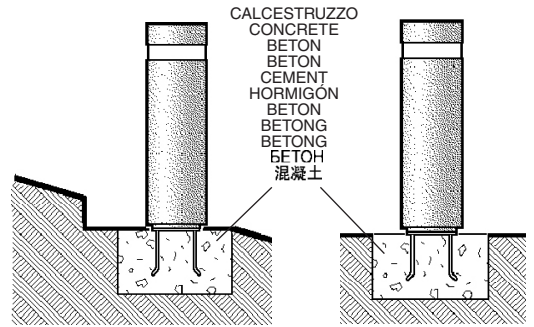

ART.	X (mm)	V (mm)	art.
B468 - B469 B472 - B479 B480 - B488 - B489 B492 - B639 - B640 B647 - B648 BG19 - BG20 BG21 - BG22	32	M 6	B514

I N.B.: Le dimensioni del Plinto sono fornite a titolo indicativo, sono state calcolate considerando un terreno con pressione ammissibile di 1,0bar (1,0 kg /cm<sup>2</sup>)  
GB N.B.: The dimensions of the plinth are purely indicative and were calculated taking into account a surface with an allowable pressure of 1.0 bar (1.0 kg/cm<sup>2</sup>)  
F N.B.: Les dimensions du massif de fondation sont fournies à titre indicatif et ont été calculées en tenant compte d'un sol dont la pression admise est égale à 1,0 bar (1,0 kg /cm<sup>2</sup>)  
D N.B.: Die Abmessungen der Plinthe sind als Richtwert angegeben und wurden für ein Gelände mit zulässigem Druck von 1,0 bar (1,0 kg /cm<sup>2</sup>) berechnet  
NL N.B.: De afmetingen van Plinto zijn slechts als voorbeeld verschaft. Zij zijn berekend op basis van een bodem met een toegestane druk van 1,0 bar (1,0 kg/cm<sup>2</sup>).  
E NOTA: Las medidas de Plinto son sólo indicativas, han sido calculadas considerando un terreno con presión admisible de 1,0bar (1,0 kg /cm<sup>2</sup>)  
DK N.B.: Dimensionerne på Plinto er omtrentlige. De er beregnet ud fra et maks. tilladt jordtryk på 1,0 bar (1,0 kg /cm<sup>2</sup>)  
N N.B.: Størrelsen på pilaren gis kun som et eksempel, den er utregnet på grunnlag av et terreng med et tillatt trykk på 1,0 bar (1,0 kg /cm<sup>2</sup>)  
S OBS! Måtten som anges för Plinto är endast ungefärliga och har beräknats på en mark med ett tillåtet tryck på 1,0 bar (1,0 kg /cm<sup>2</sup>)  
RUS ПРИМЕЧАНИЕ: Размеры Plinto, приведенные только в качестве примера, были рассчитаны с учетом почвы с допустимым давлением 1,0 бар (1,0 кг/см<sup>2</sup>)  
CN 注意：底座的外形尺寸完全是参考性的并且表面的容许压力1.0 bar (1.0 kg/cm<sup>2</sup>)要被计算考虑在内。

Proteggere la parte verniciata  
Protect the painted part  
Protéger la partie peinte  
Lackierte Seite schützen  
Bescherm het gelakte gedeelte  
Proteger la parte barnizada  
Afdæk den lakerede del.  
Beskytt den lakkerte delen.  
Skydda den lackerade delen.  
Предохраните покрашенную сторону.  
保护上漆部件。

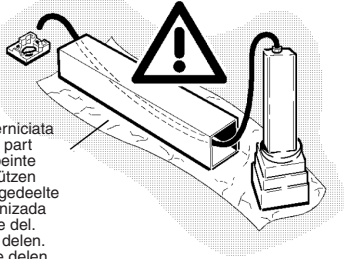

I Per il cablaggio elettrico utilizzare cavi con doppio isolamento.  
GB For the electrical wiring use cables with double insulation.  
F Pour le câblage électrique, utiliser des câbles à double isolation.  
D Für die elektrische Verdrahtung sind Kabel mit Mantel zu verwenden.  
NL Gebruik dubbel-geïsoleerde kabels voor de elektrische aansluiting.  
E Para el cableado eléctrico servirse de cables con doble aislamiento.  
DK De anvendte ledninger skal have dobbelt isolering.  
N For elektrisk kabling, bruk kabler med dobbel isolering.  
S Använd elkablar med dubbel isolering för kabeldragningen.  
RUS Для монтажа кабелепроводки используйте провода с двойной изоляцией.  
CN 针对架线，使用双重绝缘的电缆。

I In caso di danneggiamento del cavo flessibile esterno, questo deve essere sostituito dal costruttore, o dal suo servizio di assistenza, o da personale qualificato equivalente, al fine di evitare pericoli.  
GB Should the outer flexible cable be somehow damaged, the latter should be replaced by the manufacturer, or by the corresponding service centre, or by an appropriate and qualified member of staff in order to avoid all risk of danger.  
F Si le câble flexible extérieur est abîmé, faites-le remplacer par le fabricant, par son service après-vente ou par un professionnel du secteur agréé afin d'éviter tout danger.  
D Sollte das äußere Kabel beschädigt sein, so muss es aus Sicherheitsgründen vom Hersteller, dessen Kundendienst oder von dazu autorisiertem Personal ausgewechselt werden.  
NL Mocht de externe flexibele slang beschadigd worden, dan moet deze worden vervangen door de fabrikant of door een bevoegde installateur, zodat eventueel gevaar vermeden wordt.  
E En caso de daños el cable flexible externo debe substituirse por el fabricante, su servicio de asistencia o personal calificado equivalente para evitar peligros.  
DK Hvis den yderste ledning beskadiges, skal den udskiftes af producenten eller er et autoriseret N teknisk servicecenter, eller af kvalificerede fagfolk, så man undgår farlige situationer.  
S Hvis ytre fleksible kabel skulle bli skadet, skal denne skiftes ut av produsenten eller tilsvarende servicesenter eller av en egnet og kvalifisert fagperson for å unngå farensisiko.  
Om den ytre kabeln skadas ska den bytas ut av tillverkaren, av dess auktoriserade verkstad eller av likvärdig kvalificerad personal för att undvika alla typer av risker.  
RUS В случае повреждения внешнего гибкого кабеля во избежание риска поручите его замену производителю, уполномоченному сервису или квалифицированному электрику.  
如果外部软线损坏，须由生产商、对应服务中心或能胜任和资深员工更换新的电缆，以避免任何可能的危险。  
CN 针对架线，使用双重绝缘的电缆。

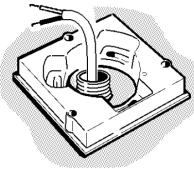

CABLAGGIO PASSANTE  
FEEDTHROUGH WIRING  
CABLAGE TRAVERSANT  
DURCHGANGSKABEL  
KABELDOORGANG  
CABLEADO PASANTE  
GENNEMGÅENDE LEDNINGER  
FÖRINGSKABLING  
KABELGJENOMFØRING  
СКВОЗНОЙ МОНТАЖ  
连接线架

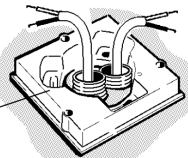

I N.B.: Per il collegamento elettrico alla rete, servirsi dell'art. BZG8 - BZH0 o di altri dispositivi di connessione in classe II che garantiscono il grado di protezione IP66.  
GB N.B.: For connection to the mains electricity supply, use item BZG8 - BZH0 or other Class II connection devices which offer the IP66 degree of protection.  
F N.B.: Pour le raccordement électrique au secteur, utiliser l'art. BZG8 - BZH0 ou tout autre dispositif de connexion en classe II assurant un indice de protection IP66.  
D N.B.: Für den elektrischen Anschluss verwenden Sie die Art. BZG8 - BZH0 oder andre Anschlussvorrichtungen der Klasse II, die den Schutzgrad IP66 gewährleisten.  
NL N.B.: Voor de aansluiting op het elektrische net moet u gebruik maken van het art. BZG8 - BZH0 of van andere verbindingsapparaten van klasse II, die een beschermingsgraad IP66 garanderen.  
E N.B.: Para la conexión eléctrica a la red, consultar el Art. BZG8 - BZH0 o emplear otros dispositivos de conexión en la clase II que garantizan el grado de protección IP66.  
DK N.B.: For elektrisk tilslutning til forsyningsnettet skal man bruge art. BZG8 - BZH0 eller en anden forbindelsesordning i klasse II, der garanterer en beskyttelsesgrad lig med IP66.  
N N.B.: For elektrisk kobling til nettet, bruk art. BZG8 - BZH0 eller andre koblingsanordninger i klasse II som sikrer vernegrad IP66.  
S OBS! För anslutningen till elnätet, använd art. BZG8 - BZH0 eller andra anslutningsanordningar i klass II som garanterar skyddsgrad IP66.  
RUS ПРИМЕЧАНИЕ: Для подключения к электрической сети используйте артикуль BZG8 - BZH0 или другие соединительные устройства класса II, обеспечивающие класс электробезопасности IP66.  
CN 注意事项:对于电子网络连接，需要BZG8 - BZH0产品或者其他的可以保证IP66的保护等级的二级连接设备。

art. B461 - B462 - B463 - B468 - B469  
B473 - B474 - B476 - B477 - B479 - B481  
B482 - B483 - B488 - B489 - B633 - B634  
B635 - B639 - B641 - B642 - B643 - B647  
BG19 - BG20 - BG21 - BG22

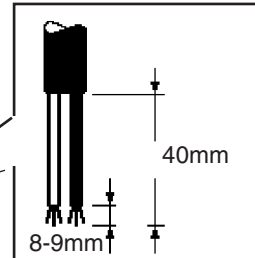
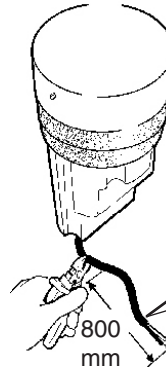

ART.

N° Prodotti collegabili / Sezione cavo  
No. of products that can be connected / Cable cross section.  
Nombre de Produits reliables / Section câble  
Anzahl der Strahler, die miteinander verbunden werden können / Kabeldurchschnitt  
N° Verbindbare producten/Doorsnee kabel  
N° de productos a conectar/Sección del cable  
Antal produkter der kan tilsluttes / Kabelsnit  
Antal produkter som kan tilkoples / kabeltværsnitt  
Antal produkter som kan anslutas/kabeltvärsnitt  
Кол-во подключаемых приборов / Сечение провода  
可连接的产品编号/电缆横截面

ART.	N° Prodotti collegabili / Sezione cavo No. of products that can be connected / Cable cross section.		
	1,5 mm <sup>2</sup>	2,5 mm <sup>2</sup>	4 mm <sup>2</sup>
B466 - B486 - B638 - B646	25	37	45
B461 - B462 - B464 - B465 B481 - B482 - B484 - B485 B633 - B634 - B636 - B637 B641 - B642 - B644 - B645	50	75	97
B463 - B467 - B468 - B472 B483 - B487 - B488 - B492 B635 - B639 - B640 - B643 B647 - B648 - BG23 - BG24 BG25 - BG26 - BG27 - BG28 BG29 - BG30 - MR81 - MR82 MR83 - MR84 - MR85 MR86 - MR87 - MR88 BW60 - BW61 - BW62 BW63 - BW64 - BW65 BW74 - BW75 - BW76 BW77 - BW78 - BW79 BW66 - BW67 - BW68 BW69 - BW70 - BW71 BW80 - BW81 - BW82 BW83 - BW84 - BW85	97	134	173
B469 - B489 - BG19 BG20 - BG21 - BG22	120	160	200
B473 - B475 - B476 - B478	45	60	80
B474 - B477	107	147	190
B479 - B480	148	203	266

ART.	art. B511	art. B512	art. BZG8	art. BZH0
B461 - B462 - B463 - B464 - B465 B466 - B467 - B473 - B474 - B475 B476 - B477 - B478 - B481 - B482 B483 - B484 - B485 - B486 - B487 B633 - B634 - B635 - B636 - B637 B638 - B641 - B642 - B643 - B644 B645 - B646 - MR81 - MR82 - MR83 MR84 - MR85 - MR86 - MR87 - MR88 BW62 - BW63 - BW64 - BW65 - BW68 BW69 - BW70 - BW71 - BW76 - BW77 BW78 - BW79 - BW81 - BW82 - BW83 BW84 - BW85	●			
B468 - B469 - B472 - B479 - B480 B488 - B489 - B492 - B639 - B640 B647 - B648 - BG19 - BG20 - BG21 - BG22		●		
BG23 - BG24 - BG25 - BG26 - BG27 BG28 - BG29 - BG30 - BW60 - BW61 BW66 - BW67 - BW74 - BW75 - BW80 BW81			●	●

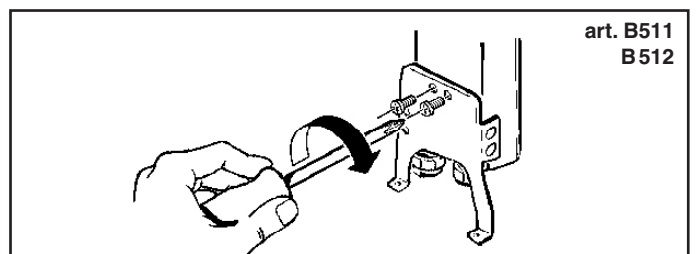

art. B511  
B512

CABLAGGIO ELETTRICO CON L'ART. B511  
 ELECTRICAL WIRING WITH ART. B511  
 CÂBLAGE ÉLECTRIQUE AVEC L'ART. B511  
 VORSCHALTGERÄT: ART. B511  
 ELEKTRISCHE BEKABELING MET ART. B511  
 CABLEADO ELÉCTRICO CON ART. B511  
 ELEKTRISK LEDNINGSFØRING MED ART. B511  
 ELEKTRISK KOPLING MED ART. B511  
 ELKABLAR MED ART. B511  
 МОНТАЖ КАБЕЛЬНОЙ ПРОВОДКИ ДЛЯ АРТИКЛЯ B511  
 ART. B511 带电线

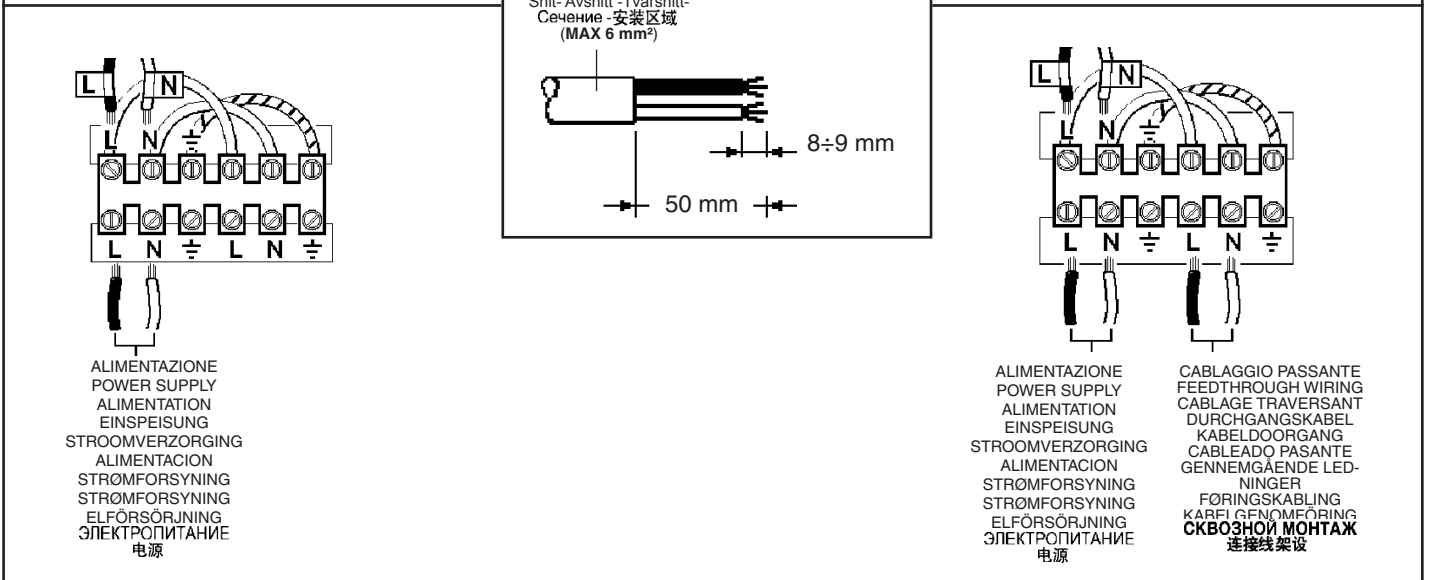
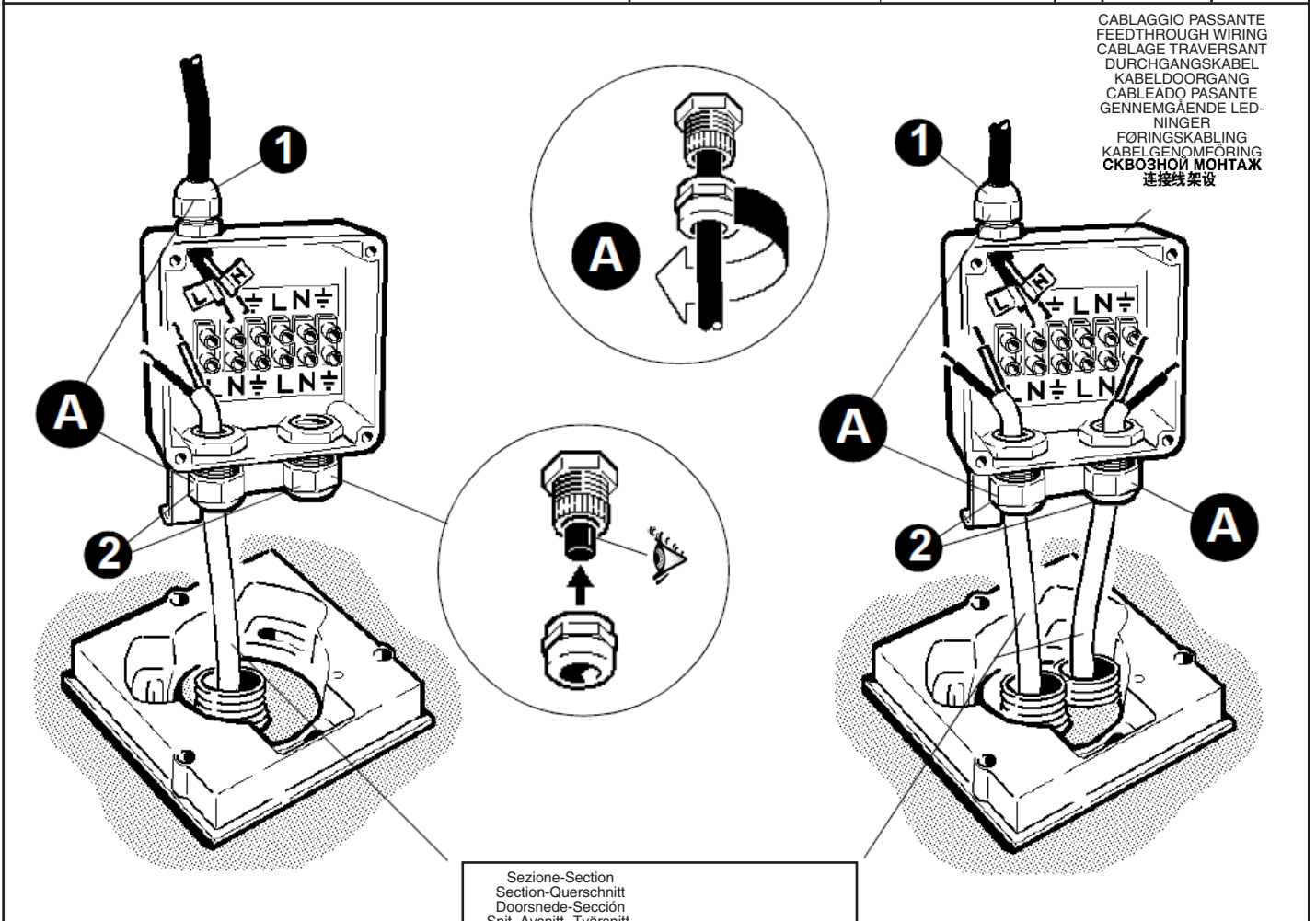
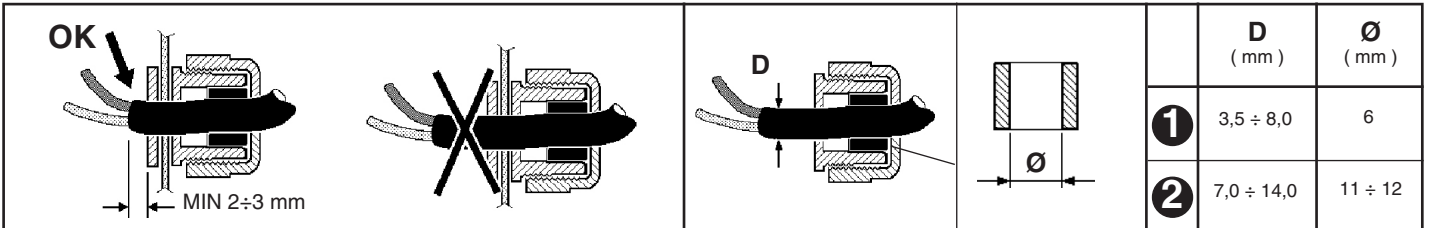

CABLAGGIO ELETTRICO CON L'ART. B512  
 ELECTRICAL WIRING WITH ART. B512  
 CÂBLAGE ÉLECTRIQUE AVEC L'ART. B512  
 VORSCHALTGERÄT: ART. B512  
 ELEKTRISCHE BEKABELING MET ART. B512  
 CABLEADO ELÉCTRICO CON ART. B512  
 ELEKTRISK LEDNINGSFØRING MED ART. B512  
 ELEKTRISK KOPLING MED ART. B512  
 ELKABLAR MED ART. B512  
 МОНТАЖ КАБЕЛЬНОЙ ПРОВОДКИ ДЛЯ АРТИКЛЯ B512  
 ART. B512带电线

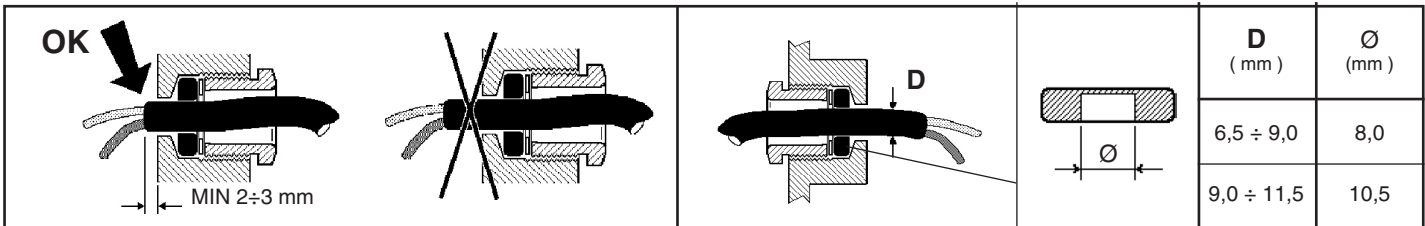

CABLAGGIO PASSANTE  
 FEEDTHROUGH WIRING  
 CABLAGE TRAVERSANT  
 DURCHGANGSKABEL  
 KABELDOORGANG  
 CABLEADO PASANTE  
 GENNEMGAENDE LED-  
 NINGER  
 FØRINGSKABLING  
 KABEL GENNEMFØRING  
 СВЯЗНОЙ МОНТАЖ  
 连接线架设

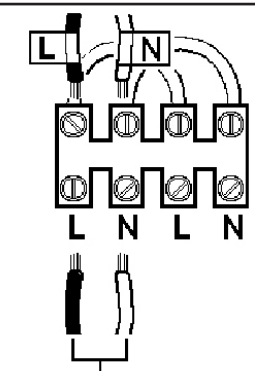
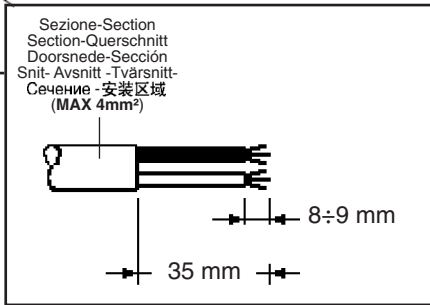
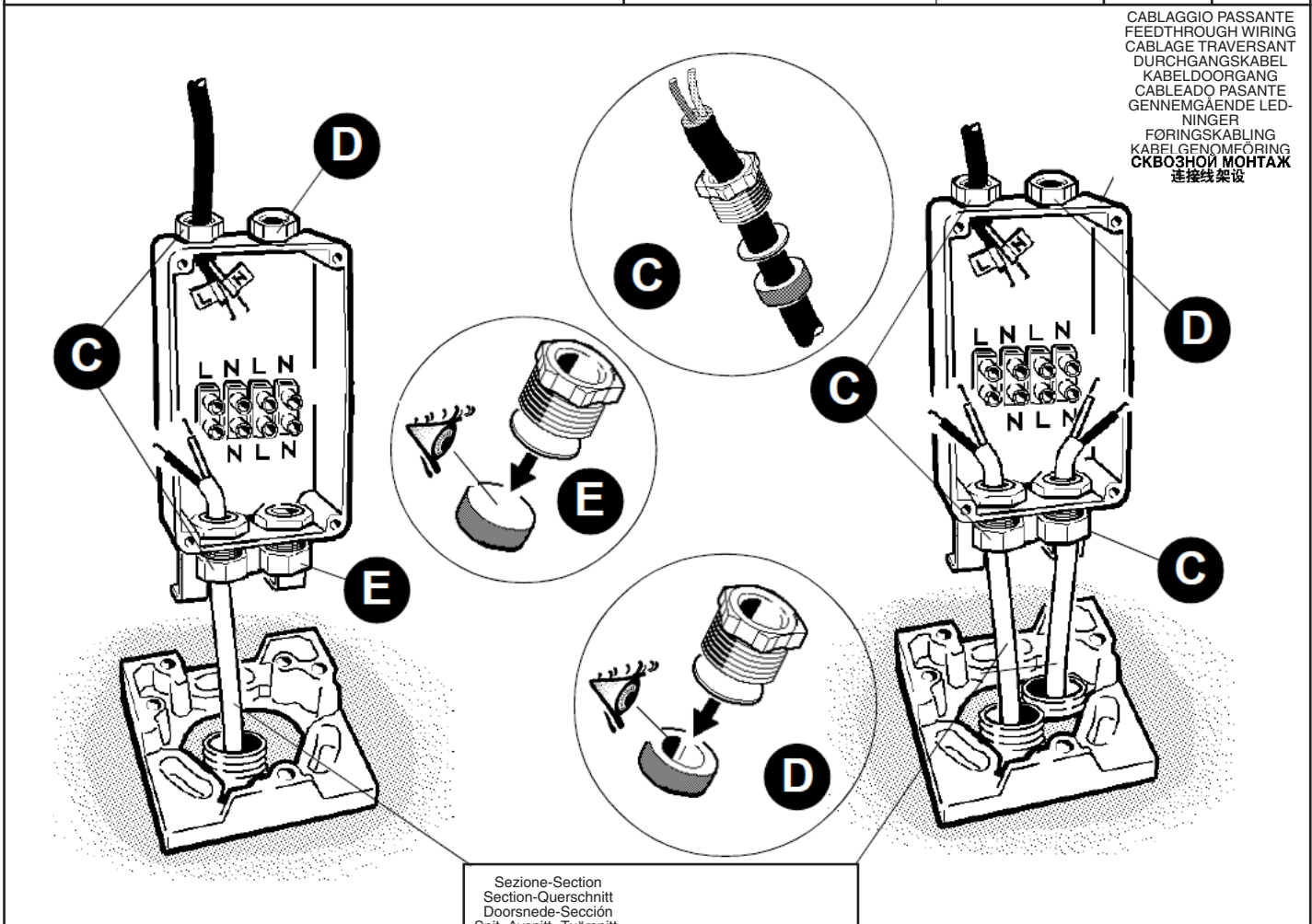

ALIMENTAZIONE  
 POWER SUPPLY  
 ALIMENTATION  
 EINSPEISUNG  
 STROOMVERZORGING  
 ALIMENTACION  
 STRØMFORSYNING  
 STRØMFORSYNING  
 ELFORSØRNING  
 ЭЛЕКТРОПИТАНИЕ  
 电源

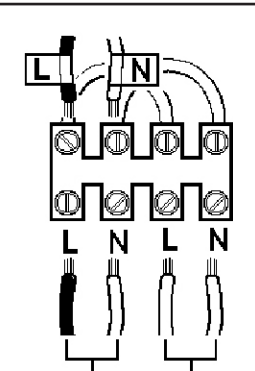

ALIMENTAZIONE  
 POWER SUPPLY  
 FEEDTHROUGH WIRING  
 CABLAGE TRAVERSANT  
 DURCHGANGSKABEL  
 KABELDOORGANG  
 CABLEADO PASANTE  
 GENNEMGAENDE LED-  
 NINGER  
 FØRINGSKABLING  
 KABEL GENNEMFØRING  
 СВЯЗНОЙ МОНТАЖ  
 连接线架设

art. B511  
B512

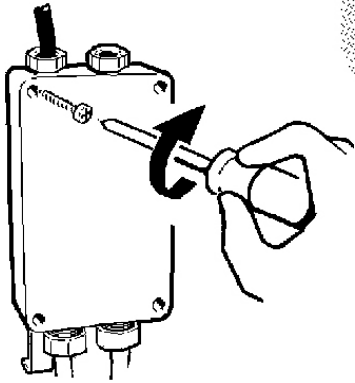
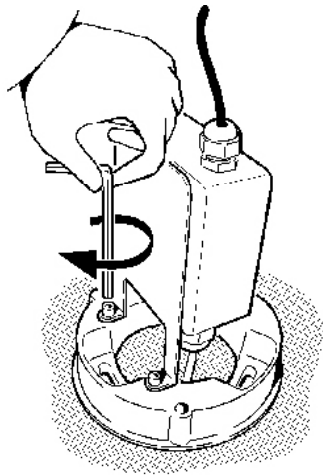

art. BG23 - BG24 - BG25 - BG26 - BG27 - BG28  
BG29 - BG30 - BW60 - BW61 - BW66  
BW67 - BW74 - BW75 - BW80  
BW81

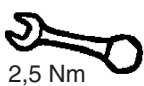
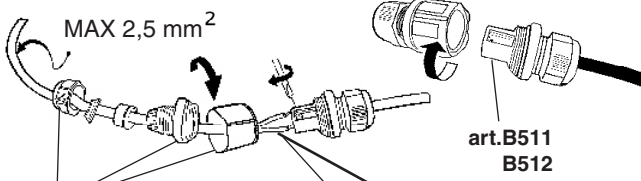

2,5 Nm

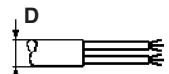
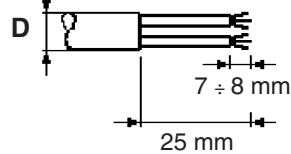
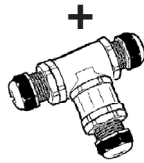

D ( mm )

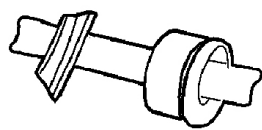

6,5 ÷ 8 mm

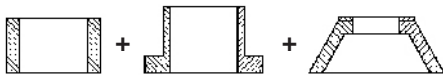

8 ÷ 9 mm

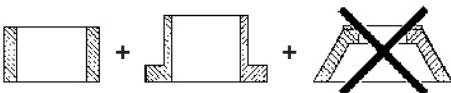

9 ÷ 13 mm

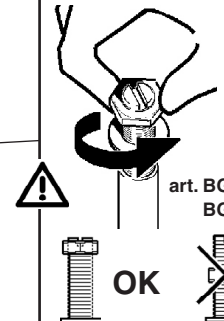
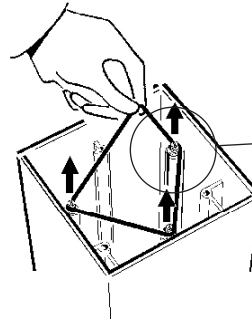
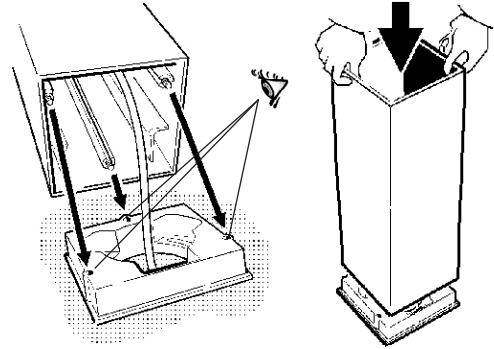
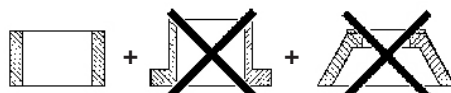

art. BG25 - BG28  
BG29 - BG30

OK



NO

I Prima di utilizzare il prodotto asportare gli elastici.  
GB Remove the elastic bands before using the product.

F Enlevez les élastiques avant d'utiliser le produit.

D Bevor Sie das Produkt verwenden, entfernen Sie die Gummis.

NL Voordat u het product gaat gebruiken moeten de elastieken verwijderd worden.

E Remover los elásticos antes de utilizar el producto.

DK Fjern elastikbåndene inden produktet tages i brug.

N Fjern de elastiske båndene før bruk av produktet.

S Ta bort gummisnoddarna innan utrustningen används.

RUS Перед началом эксплуатации прибора снимите с него резинки.

CN 在使用产品之前先取下弹性木梢。

Serrare a fondo  
Tighten firmly  
Serrer à fond  
Fest einrasten  
Goed aanschroeven  
Enrosar en firme  
Stram godt til  
Skruet i bund  
Dra åt till botten  
Закрутить до упора  
牢牢拧紧

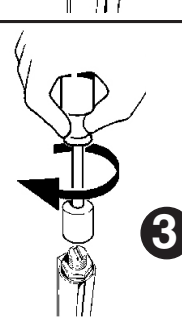
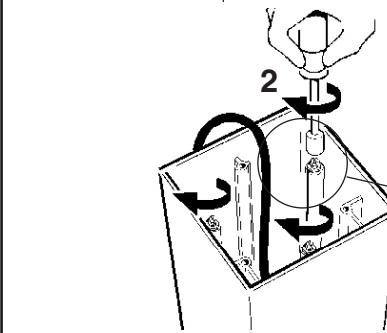
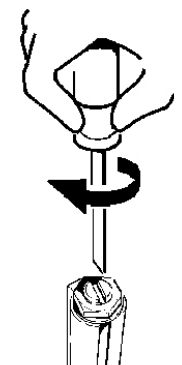
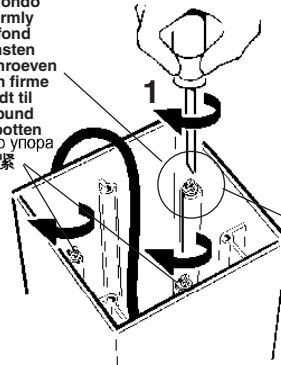

ART.

3

B461 - B462 - B463 - B464 - B465 - B466 - B467 - B473  
B474 - B475 - B476 - B477 - B478 - B481 - B482 - B483  
B484 - B485 - B486 - B487 - B633 - B634 - B635 - B636  
B637 - B638 - B641 - B642 - B643 - B644 - B645 - B646  
BG23 - BG24 - BG25 - BG26 - BG27 - BG28 - BG29 - BG30  
MR81 - MR82 - MR83 - MR84 - MR85 - MR86 - MR87  
MR88 - BW60 - BW61 - BW62 - BW63 - BW64 - BW65  
BW74 - BW75 - BW76 - BW77 - BW78 - BW79 - BW80  
BW81  
BW82 - BW83 - BW84 - BW85

MAX 10 Nm

B468 - B469 - B472 - B479 - B480 - B488 - B489  
B492 - B639 - B640 - B647 - B648 - BG19 - BG20 - BG21  
BG22

MAX 5 Nm

LATO PEDONALE O CARRABILE  
 PEDESTRIAN OR VEHICULAR SIDE  
 CÔTÉ PIÉTONS OU VOITURES  
 FUSSGÄNGER- ODER FAHRWEGSEITE  
 VOETGANGERSZIJDE OF BERIJDBARE ZIJDE  
 LADO PEATONAL O VEHICULAR  
 GANGSTI ELLER KØREBANE  
 FOTGJENGER- ELLER KJØRETØYSIDE  
 SIDA FØR FOTGÅNGARE ELLER FORDON  
 ПЕШЕХОДНАЯ ИЛИ ПРОЕЗЖАЯ СТОРОНА  
 行人或机动车侧

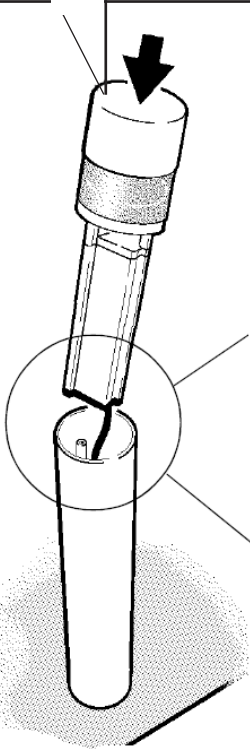
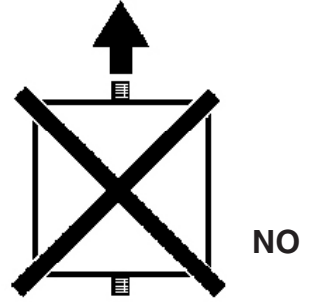
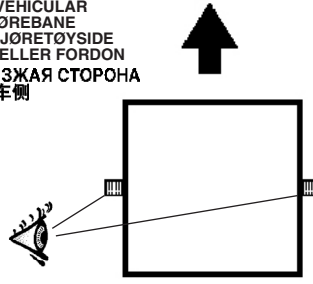
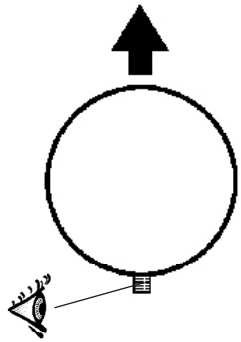

LATO PEDONALE O CARRABILE  
 PEDESTRIAN OR VEHICULAR SIDE  
 CÔTÉ PIÉTONS OU VOITURES  
 FUSSGÄNGER- ODER FAHRWEGSEITE  
 VOETGANGERSZIJDE OF BERIJDBARE  
 ZIJDE  
 LADO PEATONAL O VEHICULAR  
 GANGSTI ELLER KØREBANE  
 FOTGJENGER- ELLER KJØRETØYSIDE  
 SIDA FØR FOTGÅNGARE ELLER FORDON  
 ПЕШЕХОДНАЯ ИЛИ ПРОЕЗЖАЯ СТОРОНА  
 行人或机动车侧

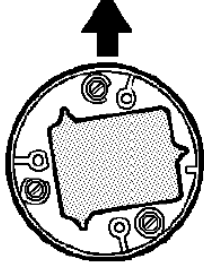

art. B468 - B469  
 B472 - B479  
 B480 - B639  
 B640  
 BG19 - BG20

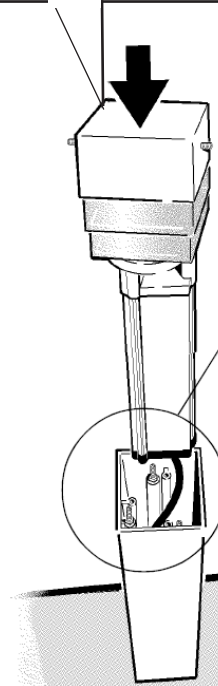

LATO PEDONALE O CARRABILE  
 PEDESTRIAN OR VEHICULAR SIDE  
 CÔTÉ PIÉTONS OU VOITURES  
 FUSSGÄNGER- ODER FAHRWEGSEITE  
 VOETGANGERSZIJDE OF BERIJDBARE  
 ZIJDE  
 LADO PEATONAL O VEHICULAR  
 GANGSTI ELLER KØREBANE  
 FOTGJENGER- ELLER KJØRETØYSIDE  
 SIDA FØR FOTGÅNGARE ELLER FORDON  
 ПЕШЕХОДНАЯ ИЛИ ПРОЕЗЖАЯ СТОРОНА  
 行人或机动车侧

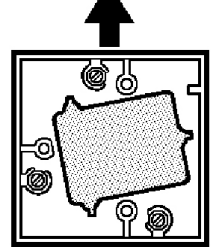

art. B488 - B489  
 B492 - B647  
 B648 - BG21  
 BG22



LATO PEDONALE O CARRABILE  
 PEDESTRIAN OR VEHICULAR SIDE  
 CÔTÉ PIÉTONS OU VOITURES  
 FUSSGÄNGER- ODER FAHRWEGSEITE  
 VOETGANGERSZIJDE OF BERIJDBARE ZIJDE  
 LADO PEATONAL O VEHICULAR  
 GANGSTI ELLER KØREBANE  
 FOTGJENGER- ELLER KJØRETØYSIDE  
 SIDA FØR FOTGÅNGARE ELLER FORDON  
 ПЕШЕХОДНАЯ ИЛИ ПРОЕЗЖАЯ СТОРОНА  
 行人或机动车侧

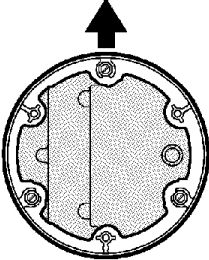

art. B461 - B462 - B463  
 B464 - B465 - B466  
 B467 - B473 - B474  
 B475 - B476 - B477  
 B478 - B633 - B634  
 B635 - B636 - B637  
 B638 - BG23 - BG24  
 BG25 - BG29 - MR81  
 MR82 - MR83 - MR84  
 BW60 - BW61 - BW62  
 BW63 - BW64 - BW65  
 BW74 - BW75 - BW76  
 BW77 - BW78 - BW79

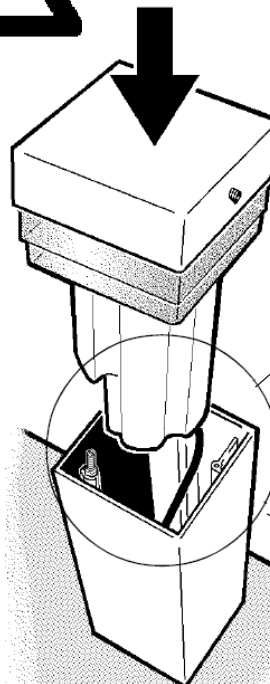
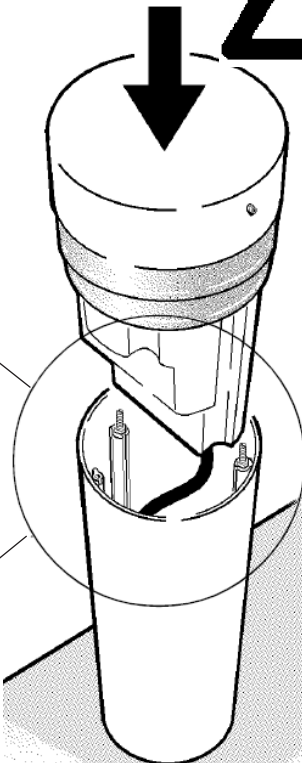

LATO PEDONALE O CARRABILE  
 PEDESTRIAN OR VEHICULAR SIDE  
 CÔTÉ PIÉTONS OU VOITURES  
 FUSSGÄNGER- ODER FAHRWEGSEITE  
 VOETGANGERSZIJDE OF BERIJDBARE ZIJDE  
 LADO PEATONAL O VEHICULAR  
 GANGSTI ELLER KØREBANE  
 FOTGJENGER- ELLER KJØRETØYSIDE  
 SIDA FØR FOTGÅNGARE ELLER FORDON  
 ПЕШЕХОДНАЯ ИЛИ ПРОЕЗЖАЯ СТОРОНА  
 行人或机动车侧

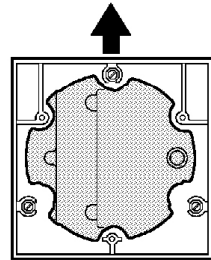

art. B481 - B482 - B483  
 B484 - B485 - B486  
 B487 - B641 - B642  
 B643 - B644 - B645  
 B646 - BG26 - BG27  
 BG28 - BG30 - MR85  
 MR86 - MR87 - MR88  
 BW66 - BW67 - BW68  
 BW69 - BW70 - BW71  
 BW80 - BW81 - BW82  
 BW83 - BW84 - BW85



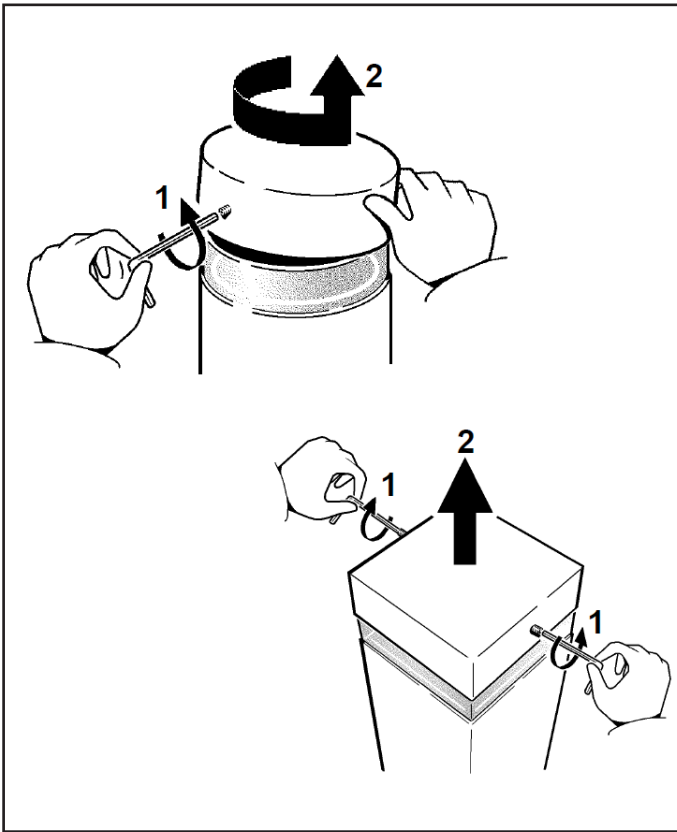

### LED VERSION

art. BG23 - BG24 - BG26 - BG27 - MR81 - MR82 - MR83  
 MR84 - MR85 - MR86 - MR87 - MR88 - BW60 - BW61  
 BW62 - BW63 - BW64 - BW65 - BW74 - BW75 - BW76  
 BW77 - BW78 - BW79 - BW66 - BW67 - BW68 - BW69  
 BW70 - BW71 - BW80 - BW81 - BW82 - BW83 - BW84  
 BW85 - B469 - B489 - BG19 - BG20 - BG21 - BG22

I Evitare qualsiasi contatto diretto con il riflettore.

GB Avoid direct contact with reflector.

F Évitez tout contact direct avec le réflecteur.

D Jeglichen direkten Kontakt mit dem Reflektor vermeiden.

NL Vermijd elk direct contact met de reflector.

E Evitar cualquier contacto directo con el reflector.

DK Undgå enhver direkte kontakt med reflektoren.

N Unngå direkte kontakt med reflektor.

S Undvik all typ av direktkontakt med reflektorn.

RUS Избегайте любого прямого касания к отражателю.

CN 请勿与反射器直接接触。

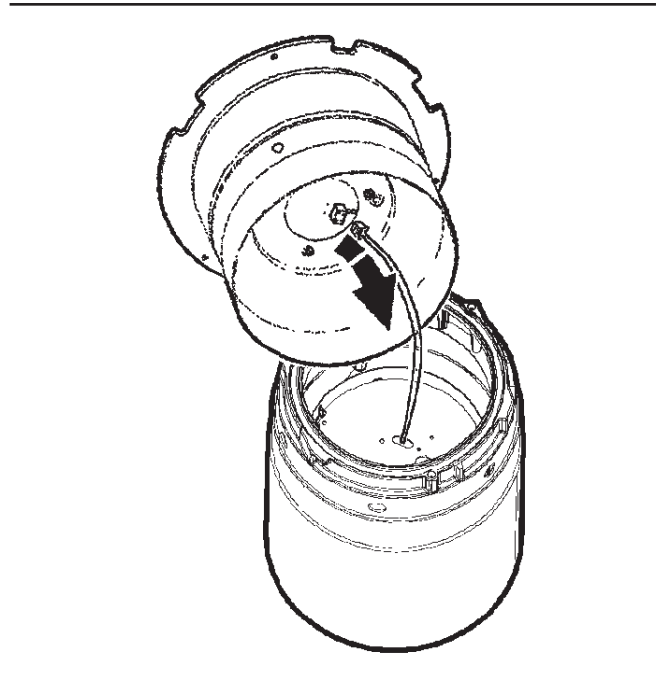
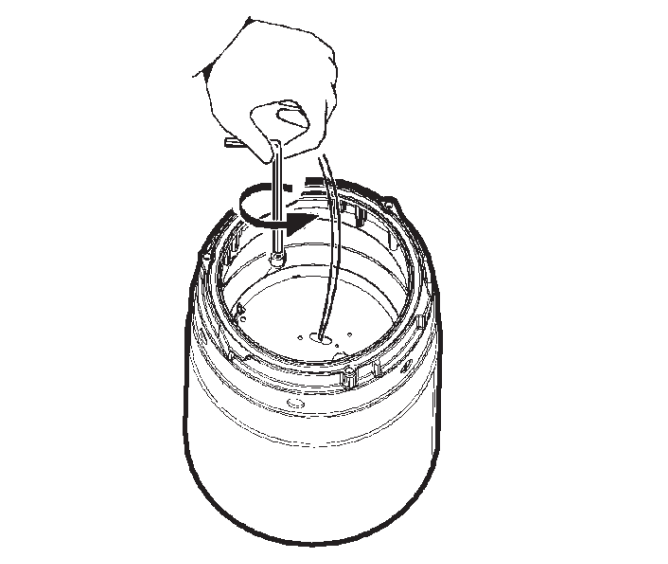
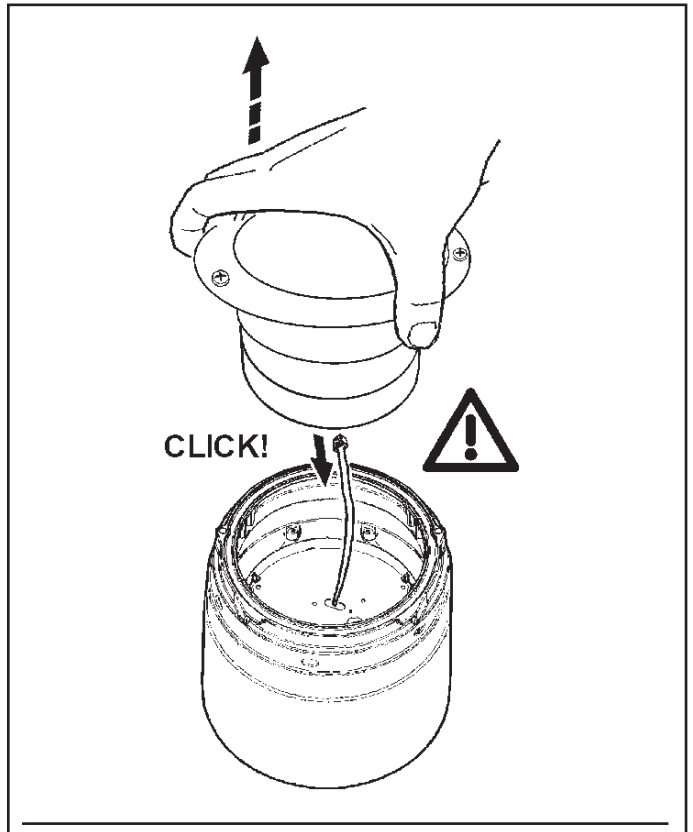
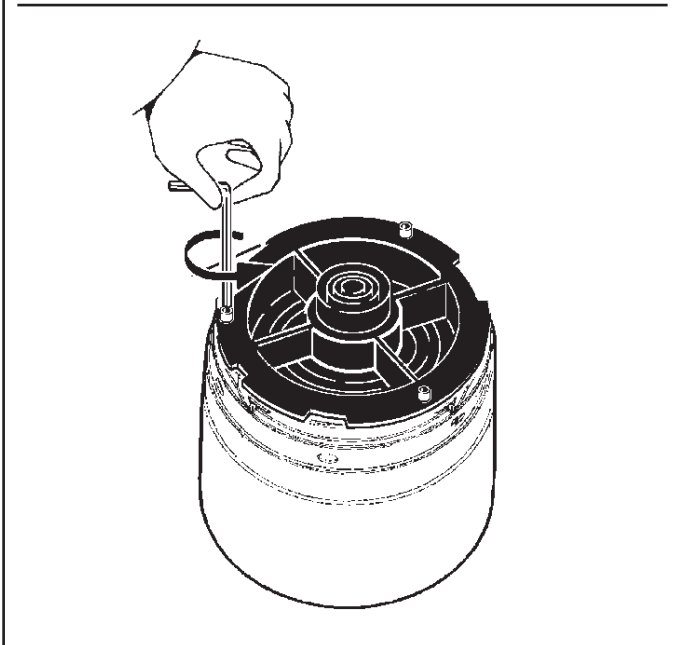

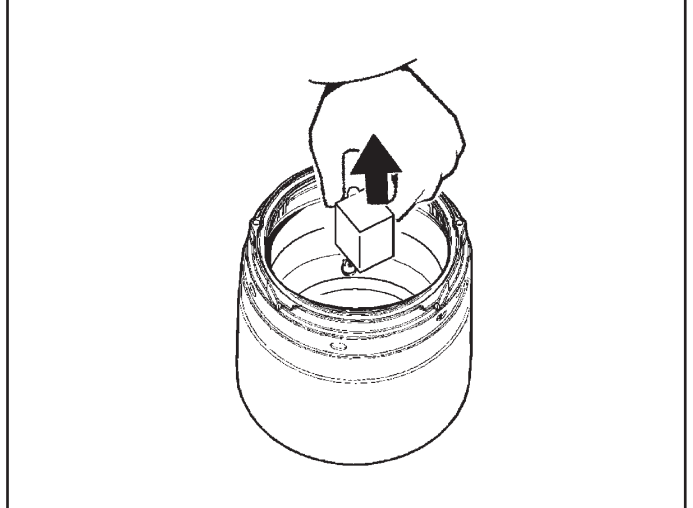
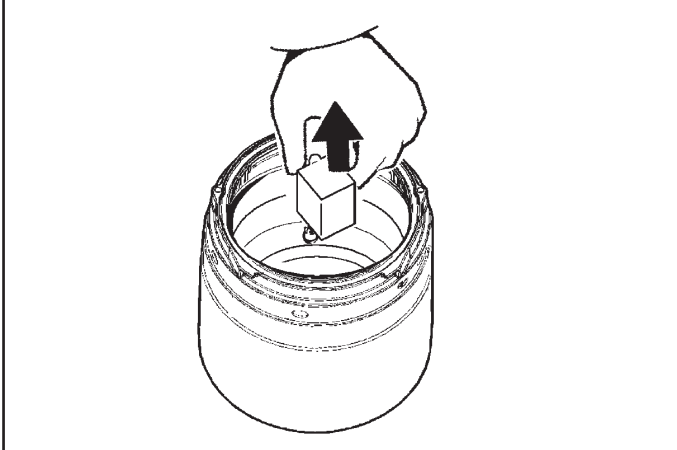
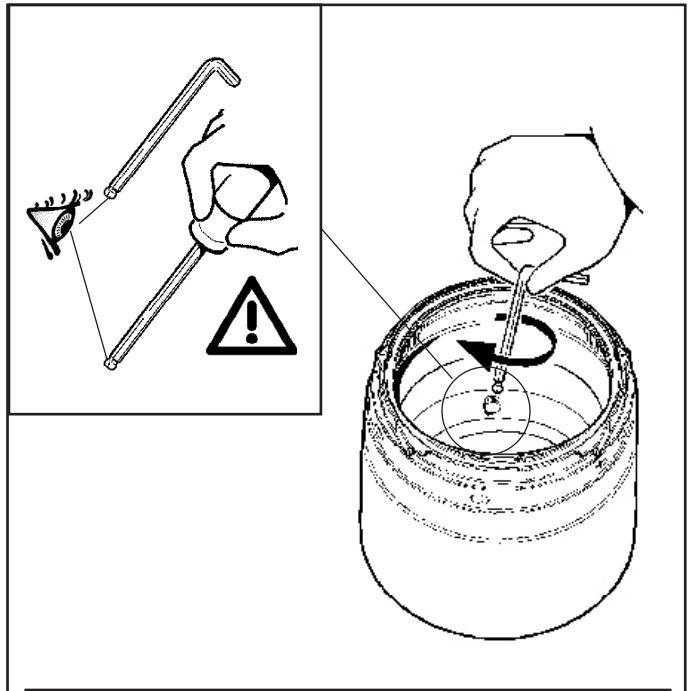
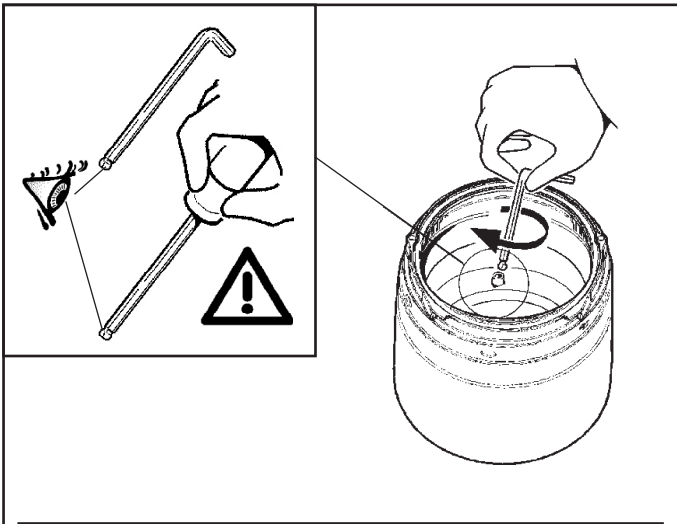

### HID VERSION

art. B461 - B462 - B463 - B464 - B465 - B466 - B467 - B473  
 B474 - B475 - B476 - B477 - B478 - B481 - B482 - B483  
 B484 - B485 - B486 - B487 - B633 - B634 - B635 - B636  
 B637 - B638 - B641 - B642 - B643 - B644 - B645 - B646  
 BG25 - BG28 - BG29 - BG30 - B468 - B472 - B479  
 B480 - B488 - B492 - B639 - B640 - B647 - B648

- I Evitare qualsiasi contatto diretto con il riflettore.
- GB Avoid direct contact with reflector.
- F Évitez tout contact direct avec le réflecteur.
- D Jeglichen direkten Kontakt mit dem Reflektor vermeiden.
- NL Vermijd elk direct contact met de reflector.
- E Evitar cualquier contacto directo con el reflector.
- DK Undgå enhver direkte kontakt med reflektoren.
- N Unngå direkte kontakt med reflektor.
- S Undvik all typ av direktkontakt med reflektorn.
- RUS Избегайте любого прямого касания к отражателю.
- CN 请勿与反射器直接接触。

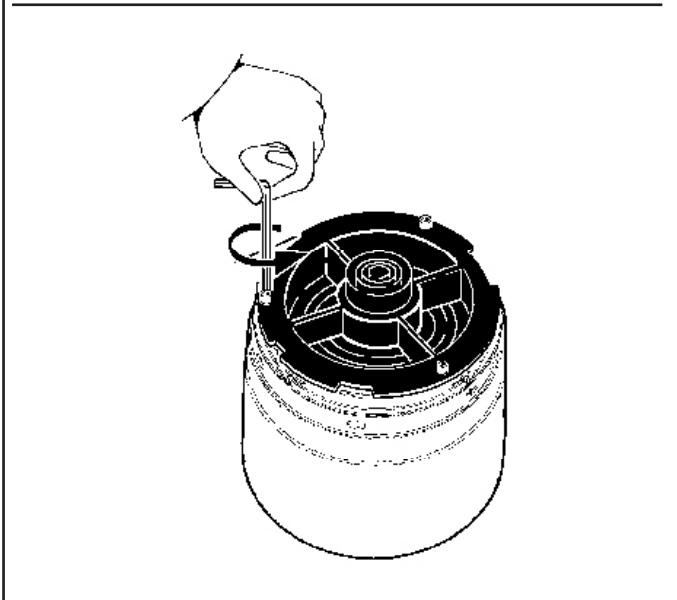

art. B473  
 B474  
 B475

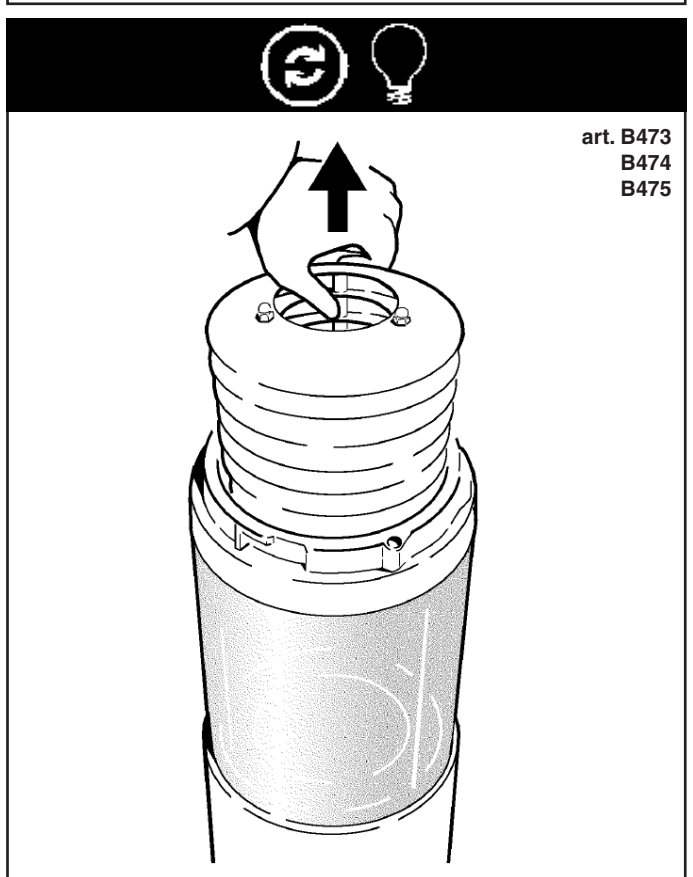

art. B461 - B462 - B464 - B465 - B466 - B481 - B482 - B484  
B485 - B486 - B633 - B634 - B636 - B637 - B638 - B641  
B642 - B644 - B645 - B646

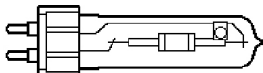

PHILIPS " CDM-T "  
OSRAM " HCI-T "

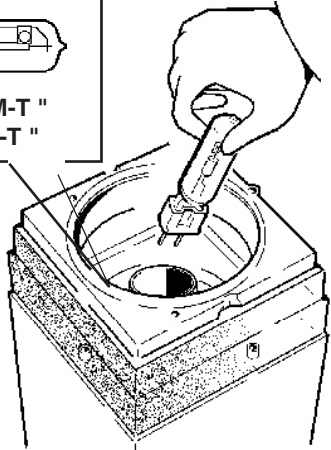

I Le prestazioni fotometriche dichiarate a catalogo sono garantite usando le lampade indicate in figura.  
N.B.: Assicurarsi che la lampada sia inserita nella sede del portalampada fino in fondo.

GB The photometric performance indicated in the catalogue is guaranteed when using the shown in the figure.  
N.B.: Make sure that the lamp is properly inserted all the way into the lamp holder.

F Les performances photométriques reportées dans notre catalogue ne sont atteintes qu'en montant les lampes indiquées (voir figure).  
N.B.: Assurez-vous que la lampe soit insérée à fond dans la douille.

D Die im Katalog angegebenen photometrischen Leistungen werden bei Einsatz der in der Abbildung veranschaulichten Lampen gewährleistet.  
N.B.: Vergewissern Sie sich bitte, daß die Lampe fest in die Lampenhalterung eingeschraubt ist.

NL De in de catalogus vermelde fotometrische prestaties worden gegarandeerd als de lampen worden gebruikt die in de afbeelding zijn aangegeven.  
N.B.: Controleer dat de lamp goed is aangedraaid in de lamphouder.

E Las prestaciones fotométricas que declara el catálogo se garantizan al utilizar las lámparas indicadas en figura.  
NOTA: Comprobar que la bombilla ha sido enroscada en el portalámparas hasta el tope.

DK Den angivne lysnormale ydelse i kataloget garanteres, hvis man bruger de angivne lyskilder, som vist i figuren.  
N.B.: Kontroller, at lyskilden sidder korrekt i fatningen og er helt i bund.

N Den fotometriske ytelsen som indikeres i katalogen garanteres ved bruk av viste lamper.  
N.B.: Påse at lampen er riktig innsatt helt inn i lampeholderen.

S Den fotometriske kapaciteten som oppges i katalogen garanteras under förutsättning att lamporna som indikeras i figuren används.  
OBS! Försäkra dig om att lampan är insatt ordentligt i botten i lamphållarens säte.

RUS Светотехнические характеристики, указанные в каталоге, гарантируются только в случае правильного подключения к сети электроснабжения.  
ПРИМЕЧАНИЕ: Проверьте, чтобы лампа была вставлена в гнездо патрона до упора.

CN 仅按图示使用时，才能保证产品目录里显示的配光性能。  
注意：确保光源正确插入灯座。

art. B473  
B474  
B475

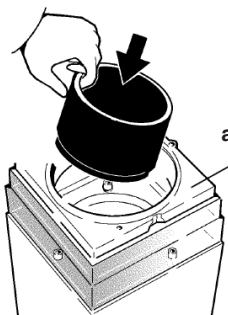
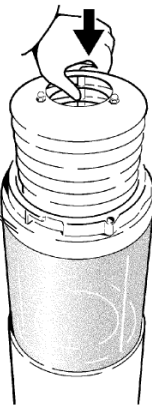

art. B633 - B634 - B635 - B636  
B637 - B638 - B641 - B642  
B643 - B644 - B645 - B646  
BG29 - BG30

art. B481 - B482 - B483 - B484  
B485 - B486 - B487 - B641  
B642 - B642 - B644 - B645  
B646 - BG26 - BG27 - BG28  
BG30 - MR81 - MR82 - MR83  
MR84 - MR85 - MR86 - MR87  
MR88 - BW60 - BW61 - BW62  
BW63 - BW64 - BW65 - BW74  
BW75 - BW76 - BW77 - BW78  
BW79 - BW66 - BW67 - BW68  
BW69 - BW70 - BW71 - BW80  
BW81 - BW82 - BW83 - BW84  
BW85

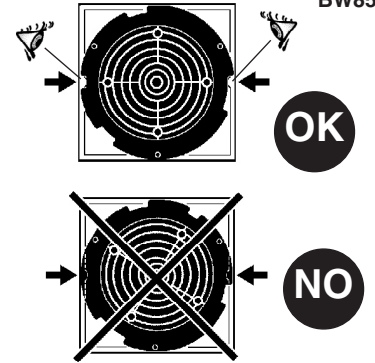
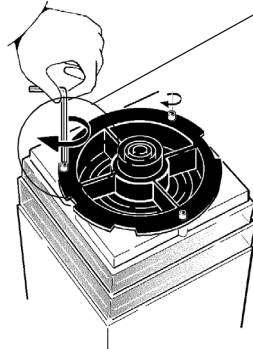

LATO PEDONALE O CARRABILE  
PEDESTRIAN OR VEHICULAR SIDE  
CÔTÉ PIÉTONS OU VOITURES  
FUSSGÄNGER- ODER FAHRWEGSEITE  
VOETGANGERSZIJDE OF BERIJDBARE ZIJDE  
LADO PEATONAL O VEHICULAR  
GANGSTI ELLER KJØREBANE  
FOTGJENGER- ELLER KJØRETØYSIDE  
SIDA FÖR FOTGÄNGARE ELLER FORDON  
ПЕШЕХОДНАЯ ИЛИ ПРОЕЗЖАЯ СТОРОНА  
行人或机动车辆侧

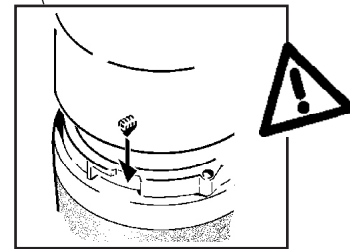
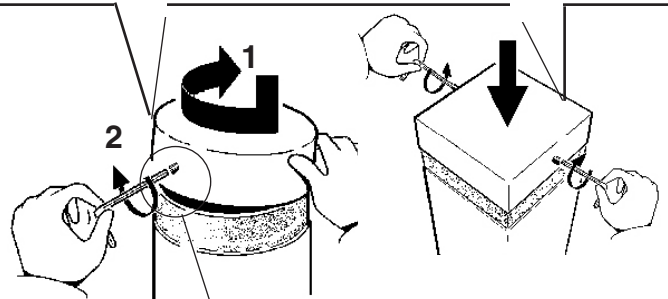
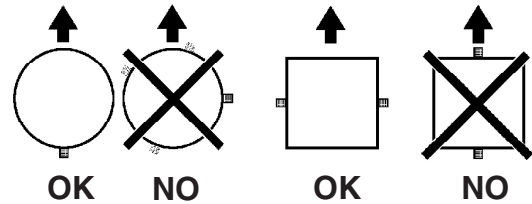

I In caso di rottura delle lenti il prodotto non può essere utilizzato, contattare il costruttore per la sua sostituzione.  
GB Should the lenses break, the product cannot be used. Contact the manufacturer for replacement.  
F En cas de rupture des lentilles, le produit ne peut plus être utilisé. Contacter le fabricant pour procéder à son remplacement.  
D Im Falle einer Beschädigung der Linsen darf das Produkt nicht verwendet werden. Setzen Sie sich bitte mit dem Hersteller in Verbindung, der für den Ersatz sorgen wird.  
NL Indien de lenzen kapot zijn kan het product niet geïnstalleerd worden. Neem contact op met de fabrikant om ze te vervangen.  
E En caso de rotura de las lentes, el producto no puede utilizarse y se debe contactar con el fabricante para su sustitución.  
DK Hvis produktets linser ødelægges, kan det ikke anvendes. Kontakt producenten med henblik på udskiftning.  
N Hvis linsene blir ødelagt kan ikke produktet brukes lenger. Ta kontakt med produsenten for å få det skiftet ut.  
S Produkten kan inte användas vid brott på linser. Kontakta tillverkaren för byte av linser.  
RUS В случае повреждения линз прибор нельзя использовать, обратиться к производителю для его замены.  
CN 如果镜头破裂，请不要使用该产品。请联系制造商进行更换。

# +ART. XXXX

ACCESSORIO  
ACCESSORY  
ACCESSOIRE  
ZUBEHÖRTEIL  
ACCESSOIRE  
ACCESSORIO  
Tilbehør  
Tilbehør  
Tilbehör  
Аксессуары  
附件



ART.	art. B503	art. B504	art. B505	art. B506	art. B507	art. B508
B461	●		●		●	
B462	●		●		●	
B463	●		●		●	
B464	●		●		●	
B465	●		●		●	
B466	●		●		●	
B467	●		●		●	
B468		●		●		●
B469		●		●		●
BG19		●		●		●
BG20		●		●		●
B472		●		●		●
B481	●		●		●	
B482	●		●		●	
B483	●		●		●	
B484	●		●		●	
B485	●		●		●	
B486	●		●		●	
B487	●		●		●	
B488		●		●		●
B489		●		●		●
BG21		●		●		●
BG22		●		●		●
B492		●		●		●
B633	●		●		●	
B634	●		●		●	
B635	●		●		●	
B636	●		●		●	
B637	●		●		●	
B638	●		●		●	
B639		●		●		●
B640		●		●		●
B641	●		●		●	
B642	●		●		●	
B643 - BG25	●		●		●	
B644 - BG28	●		●		●	
B645 - BG29	●		●		●	
B646 - BG30	●		●		●	
B647		●		●		●
B648		●		●		●

# +ART. XXXX

ACCESSORIO  
ACCESSORY  
ACCESSOIRE  
ZUBEHÖRTEIL  
ACCESSOIRE  
ACCESSORIO  
Tilbehør  
Tilbehør  
Tilbehör  
Аксессуары  
附件



ART.	art. X023	art. X024	art. X087	art. X088
BG23 - BG24				
MR81 - MR82	●		●	
MR83 - MR84				
BG26 - BG27				
MR85 - MR86		●		●
MR87 - MR88				
BW60 - BW61				
BW62 - BW63				
BW64 - BW65	●		●	
BW74 - BW75				
BW76 - BW77				
BW78 - BW79				
BW66 - BW67				
BW68 - BW69				
BW70 - BW71		●		●
BW80 - BW81				
BW82 - BW83				
BW84 - BW85				

art. B503  
B504  
MXN7

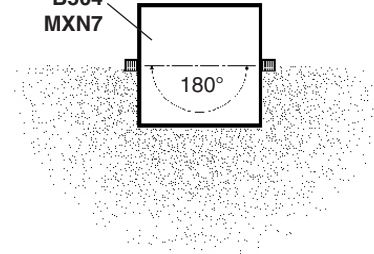

180°

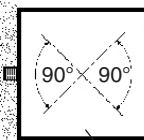

90° 90°

art. B505  
B506

art. B507  
B508

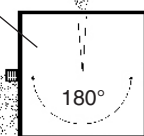
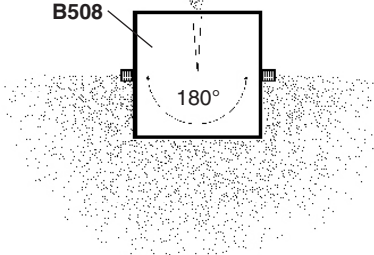

180°

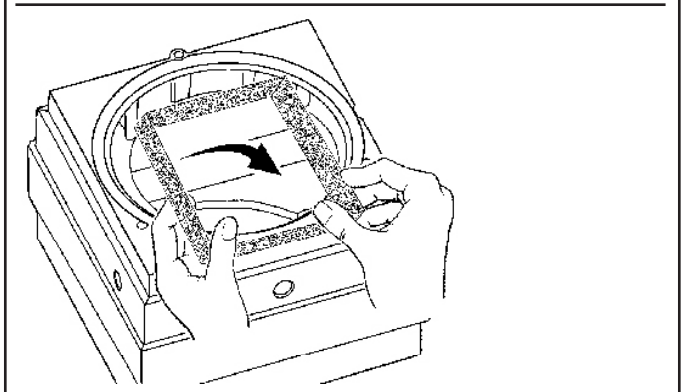
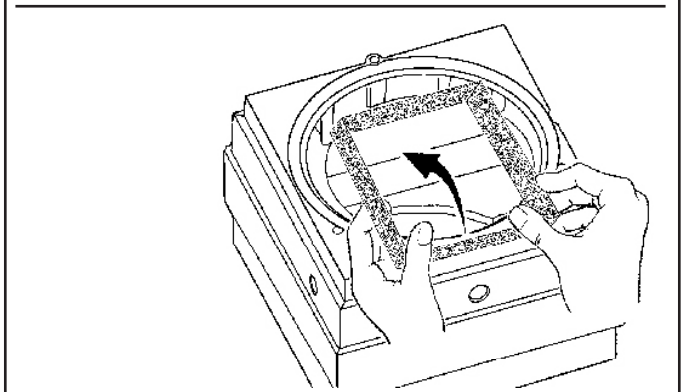
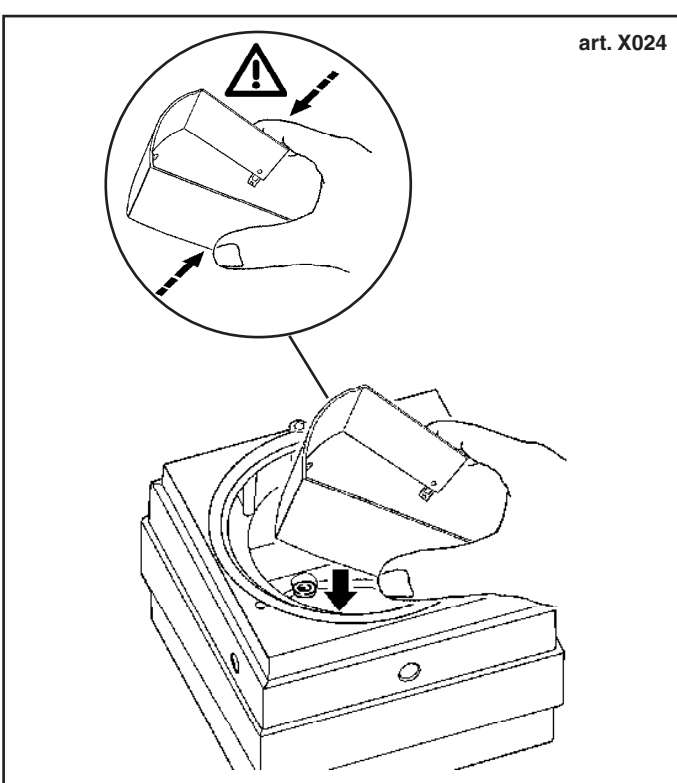
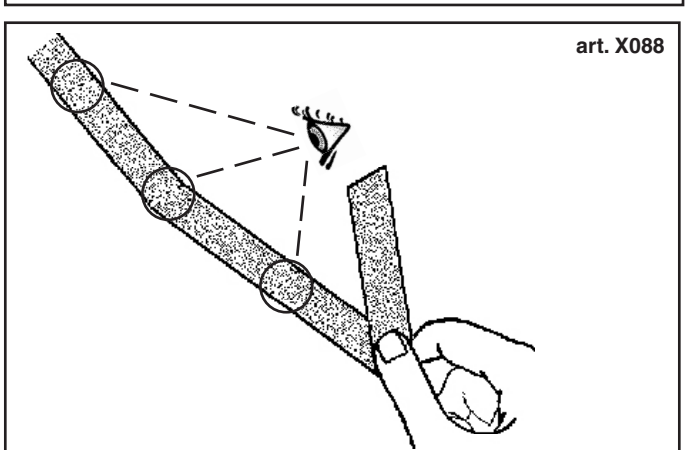
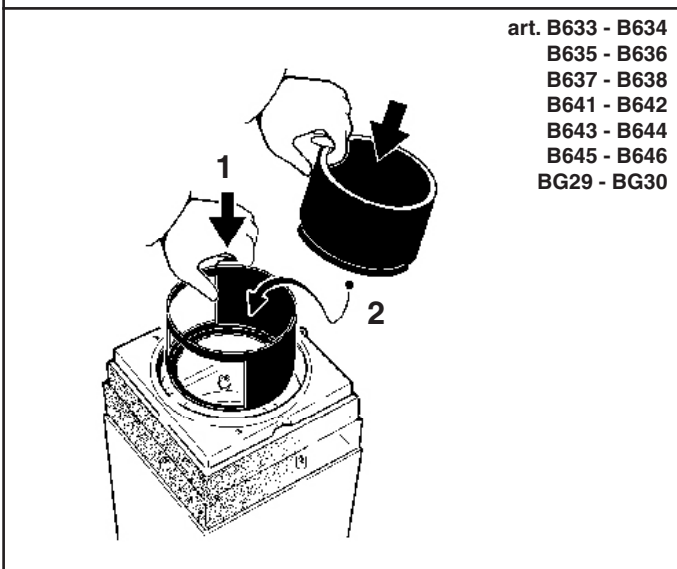
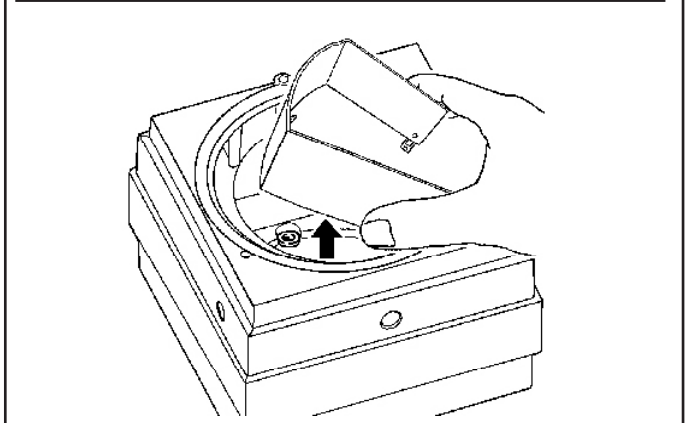
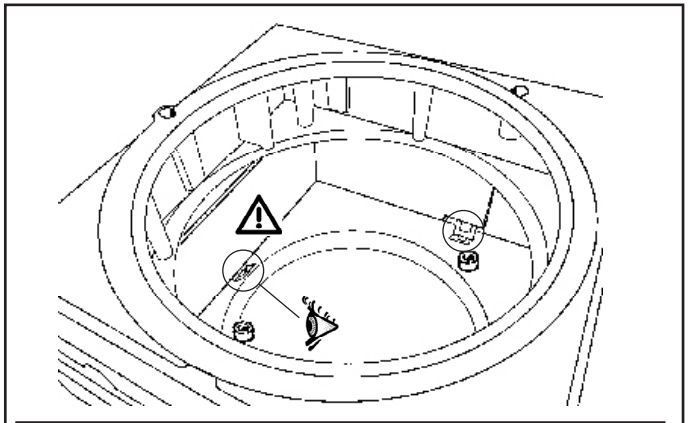
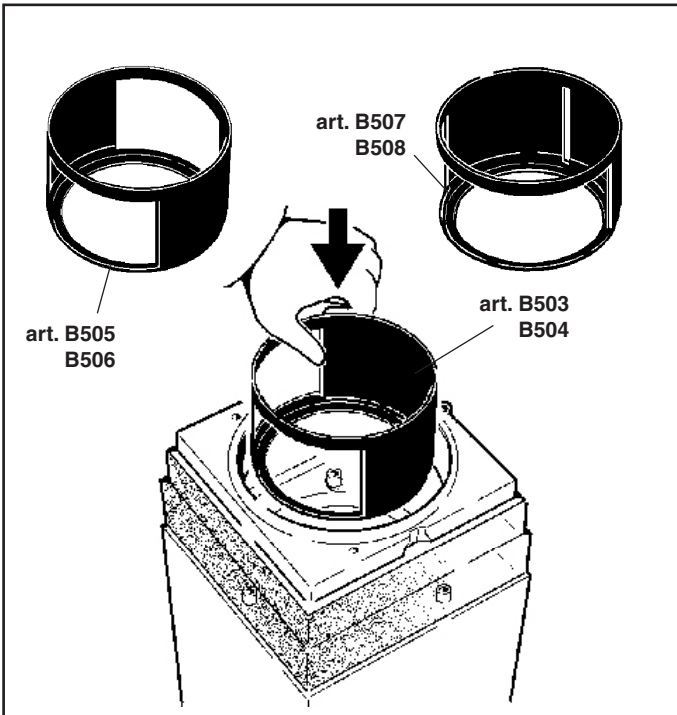

art. X023

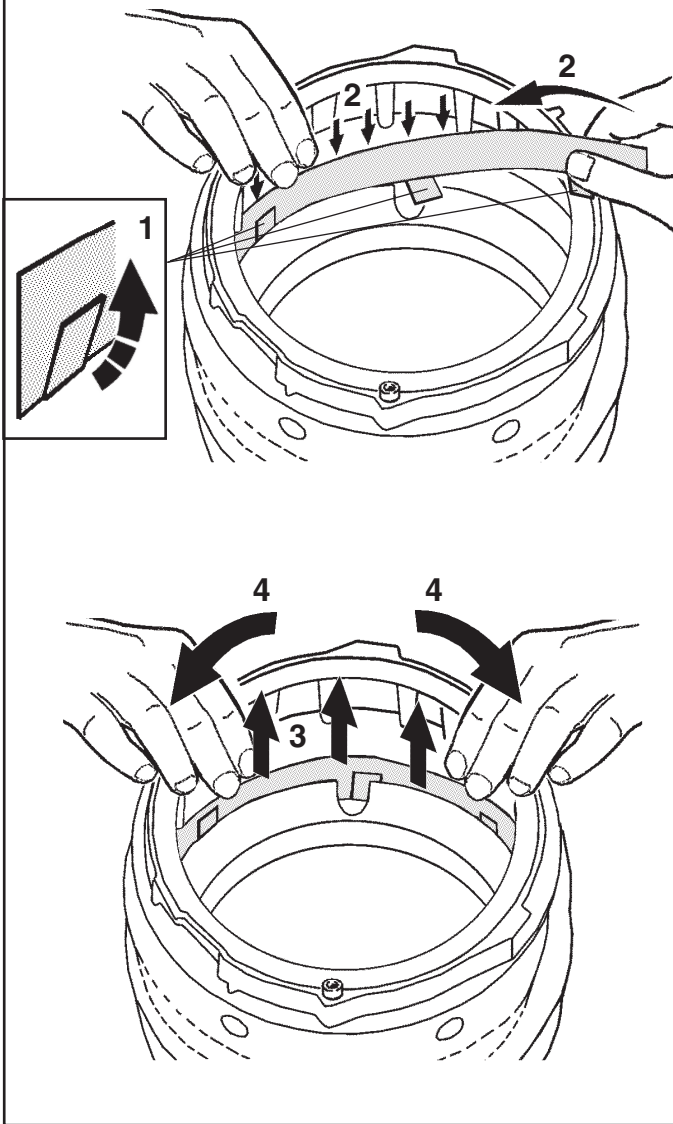

art. X087

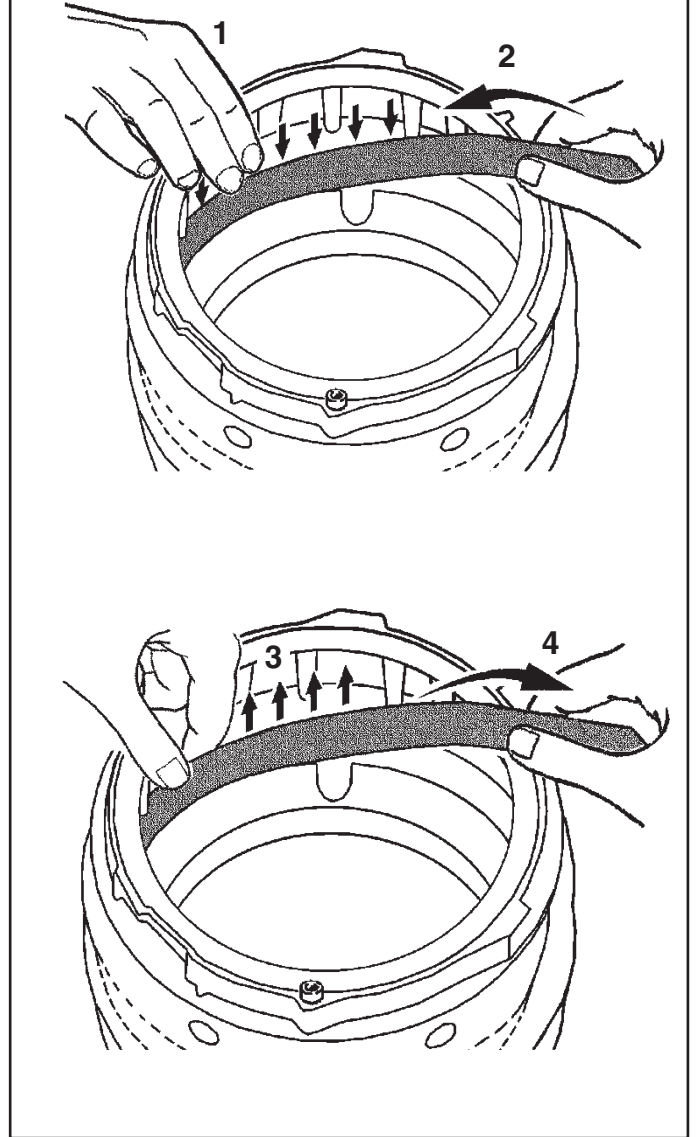

SOSTITUZIONE DEL LED  
 REPLACING THE LED  
 REMPLACEMENT DE LA LED  
 AUSTAUSCHEN DER LED  
 VERVANGEN VAN DE LED  
 REEMPLAZO DEL LED  
 UDSKIFTNING AF LYSDIODE  
 BYTE AV LYSDIOD  
 UTSKIFTING AV DEN LYSEMITTERENDE DIODEN  
 ЗАМЕНА СИД  
 发光二极管替换

- I N.B.: Per la sostituzione del LED contattare l'azienda iGuzzini.  
 GB N.B.: For information on LED replacement please contact iGuzzini.  
 F N.B.: Pour procéder au remplacement de la LED, adressez-vous à la société iGuzzini.  
 D N.B.: Bezüglich des Austausches der LED kontaktieren Sie bitte die Firma iGuzzini.  
 NL N.B.: Voor het vervangen van de LED neemt u contact op met het bedrijf iGuzzini.  
 E **NOTA:** Para sustituir el LED llame a la empresa iGuzzini.  
 DK N.B.: For udsifting av den lysemitterende dioden ta kontakt med firmaet iGuzzini.  
 N N.B.: For udsifting av lysdioden, skal man kontakte iGuzzini.  
 S **OBS!** För byte av lysdioden, kontakta företaget iGuzzini.  
 RUС **ПРИМЕЧАНИЕ:** Для замены СИДов обращайтесь в компанию iGuzzini.  
 CN 注意: 有关发光二极管照明替换信息, 请联系 iGuzzini 公司。

## iWAY

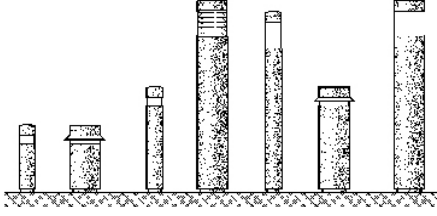

### موضع التركيب

POSIZIONE D'INSTALLAZIONE  
INSTALLATION POSITION  
POSICION DE INSTALACION

Pag.1

### المسافة بين مراكز الثقوب

INTERASSI DI FORATURA  
CENTRE TO CENTRE DISTANCE BETWEEN HOLES  
ENTRE-AXES DE PERCAGE  
DISTANCIA ENTRE LOS EJES DE PERFORACIÓN

Pag. 2

### التمديدات الكهربائية

CABLAGGIO ELETTRICO  
ELECTRIC WIRING  
CABLAJE ELÉCTRICO

Pag. 3

### تركيب واستبدال الللمبة

INSTALLAZIONE E SOSTITUZIONE DELLA LAMPADA  
INSTALLING AND REPLACING THE LAMP  
INSTALACIÓN Y REEMPLAZO DEL FOCO

Pag. 8

### تركيب واستبدال زجاج الحماية

INSTALLAZIONE E SOSTITUZIONE DEL VETRO DI PROTEZIONE  
INSTALLING AND REPLACING THE PROTECTION GLASS  
INSTALACION Y REEMPLAZO DEL CRISTAL DE PROTECCION

Pag. 10

### تركيب الملحقات

INSTALLAZIONE DEGLI ACCESSORI  
INSTALLING THE ACCESSORIES  
INSTALACION DE ACCESORIOS

Pag. 10

### تحذير :

لا يمكن ضمان سلامة هذا الجهاز إلا إذا التزمت بهذه التعليمات. يجب حفظها في مكان آمن.

**ATTENZIONE:**  
LA SICUREZZA DELL'APPARECCHIO E' GARANTITA SOLO CON L'USO APPROPRIATO DELLE SEGUENTI ISTRUZIONI; PERTANTO E' NECESSARIO CONSERVARLE.

**WARNING:**  
THE SAFETY OF THIS FIXTURE IS GUARANTEED ONLY IF YOU COMPLY WITH THESE INSTRUCTIONS; REMEMBER TO CONSERVE IN A SAFE PLACE.

**ATENCION:**  
LA SEGURIDAD DEL APARATO SE GARANTIZA SOLO CUMPLIENDO CUIDADOSAMENTE LAS SIGUIENTES INSTRUCCIONES; POR ELLO, ES NECESARIO CONSERVARLAS.

ملاحظة: ملاحظة: أثناء تركيب نظام . يجب التقيد بحرص بالنظم السائدة المتعلقة بالشبكة الكهربائية.

N.B.: DURANTE L'INSTALLAZIONE DEL SISTEMA "iWAY" RISPETTARE SCRUPOLOSAMENTE LE NORME IMPIANTISTICHE VIGENTI.

N.B.: WHEN INSTALLING THE SYSTEM "iWAY", STRICTLY COMPLY WITH ALL REGULATIONS ON INSTALLATION IN FORCE.

N.B.: DURANTE LA INSTALACIÓN DEL SISTEMA "iWAY" RESPETAR ESCRUPULOSAMENTE LAS NORMAS DE INSTALACIÓN VIGENTES.

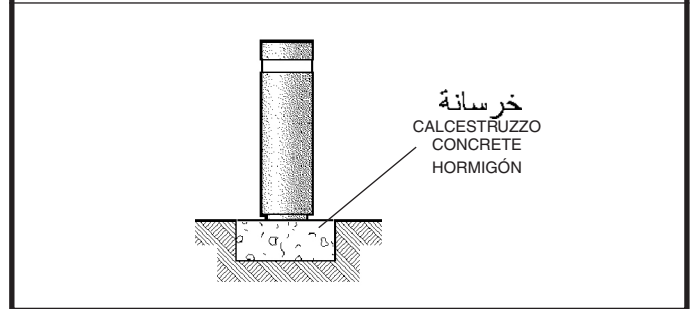
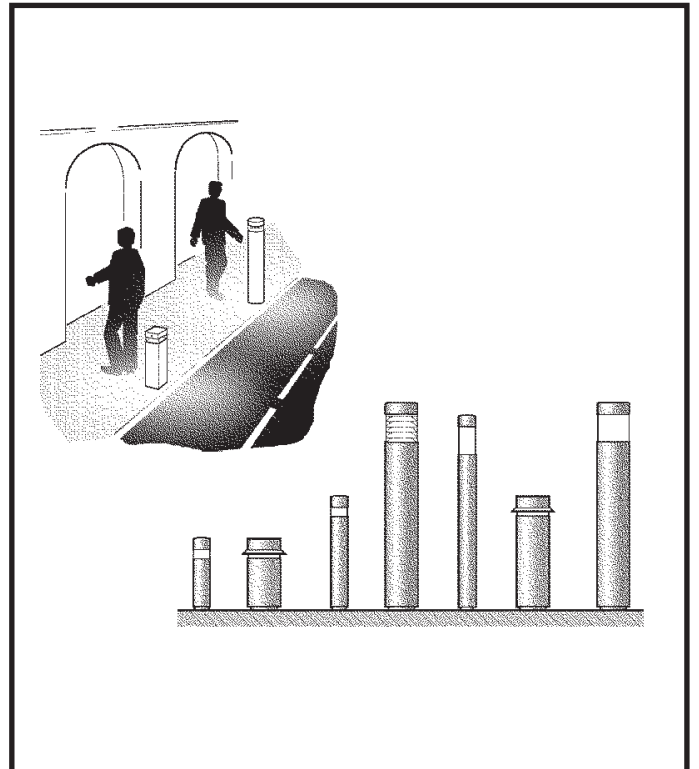
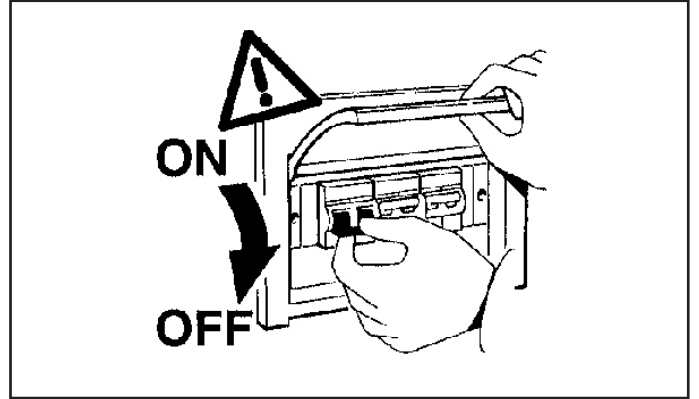

ملاحظة: عند تركيب الجهاز يجب مراعاة عدم دفن القاعدة أو وضعها في الأماكن المعرضة للرطوبة بالمياه.

I N.B.: Installando l'apparecchio, evitare che la base venga interrata o posizionata in punti soggetti al ristagno dell'acqua.

GB N.B.: Whilst installing the appliance, avoid concealing its base or placing it in areas which are susceptible to damp.

E NOTA: Al instalar el aparato, evite que la base se entierre o se coloque en puntos donde se pueda estancar el agua.

الصنف art. B461  
B462 - B463 - B464  
B465 - B466 - B467  
B473 - B474 - B475  
B476 - B477 - B478  
B633 - B634 - B635  
B636 - B637 - B638  
BG25 - BG29 - BG23  
BG24 - MR81 - MR82  
MR83 - MR84 - BW60  
BW61 - BW62 - BW63  
BW64 - BW65 - BW74  
BW75 - BW76 - BW77  
BW78 - BW79

جانب المشاة أو الدراجات الهوائية  
LATO PEDONALE O CARRABILE  
PEDESTRIAN OR VEHICULAR SIDE  
LADO PEATONAL O VEHICULAR

الصنف art. B481  
B482 - B483 - B484  
B485 - B486 - B487  
B641 - B642 - B643  
B644 - B645 - B646  
BG28 - BG30 - BG26  
BG27 - MR85 - MR86  
MR87 - MR88 - BW66  
BW67 - BW68 - BW69  
BW70 - BW71 - BW80  
BW81 - BW82 - BW83  
BW84 - BW85

عند التثبيت ينصح باستخدام مسامير كبيرة نوع FZA-I-M 8 أو ما شابهها ومن صنع شركات أخرى.

PER IL FISSAGGIO SI CONSIGLIA DI UTILIZZARE TASSELLI PER ANCORAGGI PESANTI TIPO FZA-I-M 8 FISCHER, O SIMILARI ANCHE DI ALTRI COSTRUTTORI.

FOR FIXING USE HEAVY DUTY PLUGS, SUCH AS FZA-I-M 8 FISCHER OR SIMILAR, INCLUDING FROM OTHER MANUFACTURERS.

PARA LA FIJACIÓN SE RECOMIENDA UTILIZAR TACOS PARA ANCLAJES DE GRAN RESISTENCIA, TIPO FZA-I-M 8 FISCHER, O SIMILARES, INCLUSO DE OTROS FABRICANTES.

تركيب مع الصنف B513

INSTALLAZIONE CON L'ART. B513  
INSTALLATION WITH ART. B513  
INSTALACION CON ART. B513

خرسانة  
CALCESTRUZZO  
CONCRETE  
HORMIGÓN

الصنف art. B513

الصنف ART.	X (mm) ملم	V (mm) ملم	الصنف art.
B461 - B462 - B463 - B464 - B465 B466 B467 - B474 - B473 - B475 B476 - B477 - B478 - B481 - B482 B483 - B484 - B485 - B486 - B487 B633 - B634 - B635 - B636 - B637 B638 - B641 - B642 - B643 - B644 B645 - B646 - BG23 - BG24 - BG25 BG28 - BG26 - BG27 - BG29 - BG30 MR81 - MR82 - MR83 - MR84 - MR85 MR86 - MR87 - MR88 - BW60 - BW61 BW62 - BW63 - BW64 - BW65 - BW74 BW75 - BW76 - BW77 - BW78 - BW79 BW66 - BW67 - BW68 - BW69 - BW70 BW71 - BW80 - BW81 - BW82 - BW83 BW84 - BW85	56	M 8	B513

ملحوظة هامة: تعد أبعاد القاعدة المذكورة بغرض إرشادي فقط وقد تم قياسها مع الأخذ في الاعتبار بأن الأرضية تتحمل ضغط 1,0 بار (1,0 كجم /سم<sup>2</sup>)

I N.B.: Le dimensioni del Plinto sono fornite a titolo indicativo, sono state calcolate considerando un terreno con pressione ammissibile di 1,0bar (1,0 kg /cm<sup>2</sup>)

GB N.B.: The dimensions of the plinth are purely indicative and were calculated taking into account a surface with an allowable pressure of 1.0 bar (1.0 kg/cm<sup>2</sup>)

E NOTA: Las medidas de Plinto son sólo indicativas, han sido calculadas considerando un terreno con presión admisible de 1,0bar (1,0 kg /cm<sup>2</sup>)



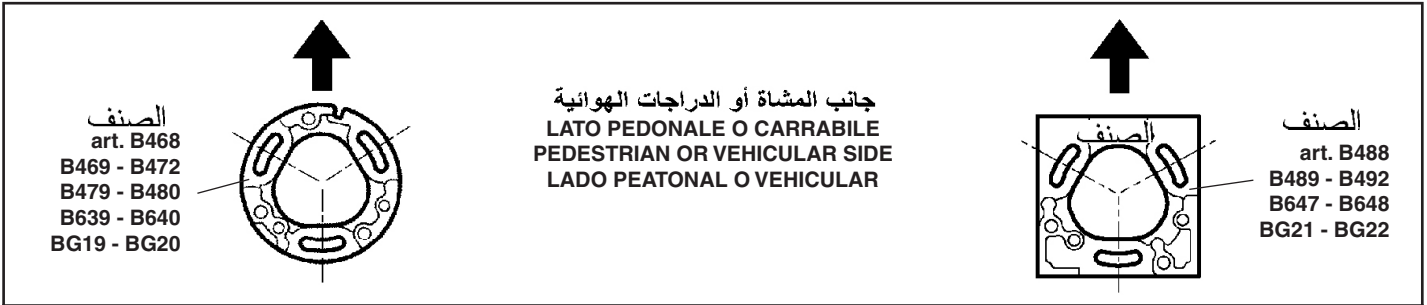

عند التثبيت ينصح باستخدام مسامير كبيرة نوع FZA-I-M 6 أو ما شابهها ومن صنع شركات أخرى.

تركيب مع الصنف B514  
 INSTALLAZIONE CON L'ART. B514  
 INSTALLATION WITH ART.B514  
 INSTALACION CON ART. B514

PER IL FISSAGGIO SI CONSIGLIA DI UTILIZZARE TASSELLI PER ANCORAGGI PESANTI TIPO FZA-I-M 6 FISCHER, O SIMILARI ANCHE DI ALTRI COSTRUTTORI.  
 FOR FIXING USE HEAVY DUTY PLUGS, SUCH AS FZA-I-M 6 FISCHER OR SIMILAR, INCLUDING FROM OTHER MANUFACTURERS.  
 PARA LA FIJACIÓN SE RECOMIENDA UTILIZAR TACOS PARA ANCLAJES DE GRAN RESISTENCIA, TIPO FZA-I-M 6 FISCHER, O SIMILARES, INCLUSO DE OTROS FABRICANTES.

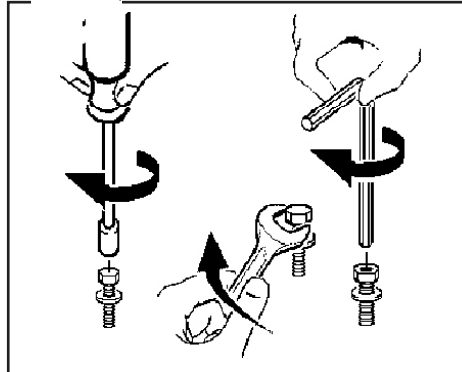
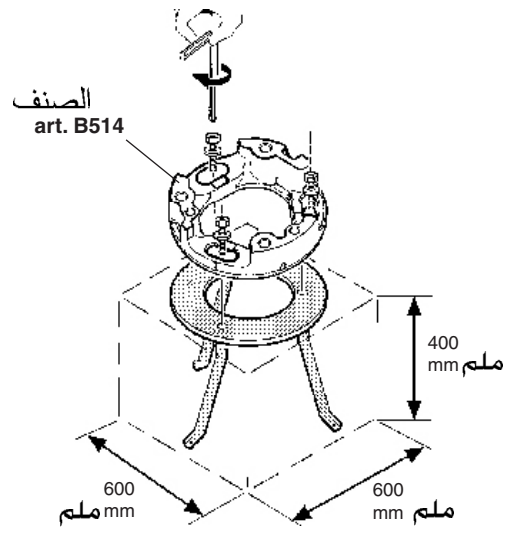
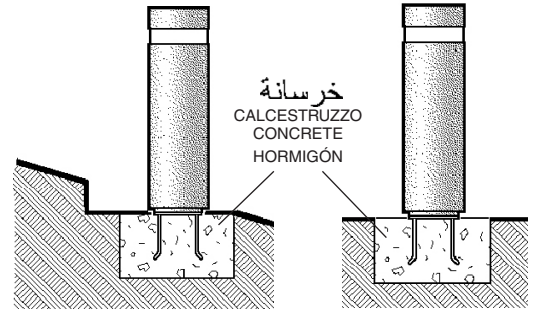
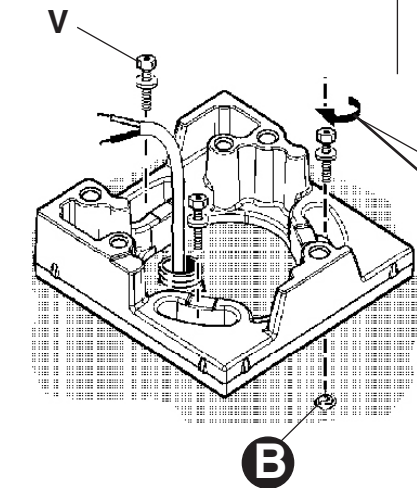
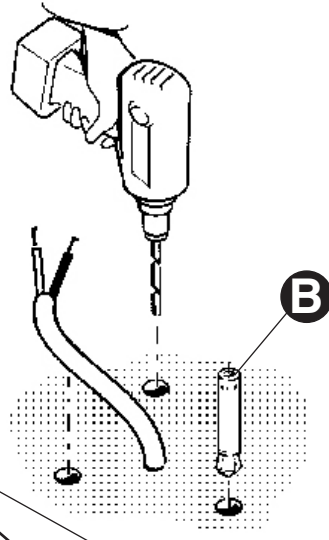
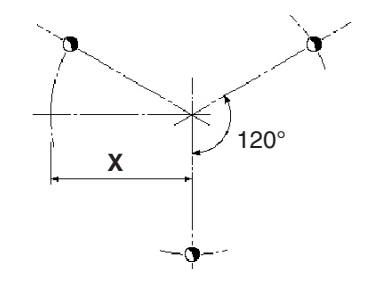

الصنف ART.	X (mm) ملم	V (mm) ملم	art.
B468 - B469 B472 - B479 B480 - B488 - B489 B492 - B639 - B640 B647 - B648 BG19 - BG20 BG21 - BG22	32	M 6	B514

ملحوظة هامة: تعد أبعاد القاعدة المذكورة بفرض إرشادي فقط وقد تم قياسها مع الأخذ في الاعتبار بأن الأرضية تتحمل ضغط 1,0 بار (1,0 كجم /سم<sup>2</sup>)  
 I N.B.: Le dimensioni del Plinto sono fornite a titolo indicativo, sono state calcolate considerando un terreno con pressione ammissibile di 1,0bar (1,0 kg /cm<sup>2</sup>)  
 GB N.B.: The dimensions of the plinth are purely indicative and were calculated taking into account a surface with an allowable pressure of 1.0 bar (1.0 kg/cm<sup>2</sup>)  
 E NOTA: Las medidas de Plinto son sólo indicativas, han sido calculadas considerando un terreno con presión admisible de 1,0bar (1,0 kg /cm<sup>2</sup>)

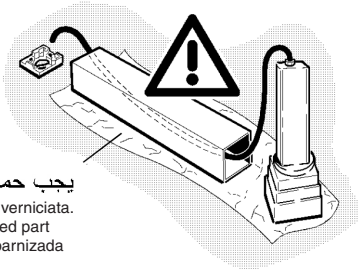

يجب حماية الجزء المطلي.  
Proteggere la parte verniciata.  
Protect the painted part  
Proteger la parte barnizada

### التمديدات الكهربائية

CABLAGGIO ELETTRICO  
ELECTRIC WIRING  
CABLEADO ELÉCTRICO

استعمل كبلًا يعازل مزدوج للتمديدات الكهربائية.

- ع  
I Per il cablaggio elettrico utilizzare cavi con doppio isolamento.  
GB Use cable with double insulation for the electric wiring.  
E Para el cableado eléctrico servirse de cables con doble aislamiento.

في حال تلف الكبل الخارجي المرص، يجب تغييره من قبل  
المصنع أو من قبل مركز الخدمة المخول أو من قبل أحد  
أعضاء الطاقم الملائمين والمؤهلين وبذلك لتحاكي إلحاق أي  
خطر.

- I In caso di danneggiamento del cavo flessibile esterno, questo deve essere sostituito dal costruttore, o dal suo servizio di assistenza, o da personale qualificato equivalente, al fine di evitare pericoli.  
GB Should the outer flexible cable be somehow damaged, the latter should be replaced by the manufacturer, or by the corresponding service centre, or by an appropriate and qualified member of staff in order to avoid all risk of danger.  
E En caso de daños el cable flexible externo debe substituirse por el fabricante, su servicio de asistencia o personal calificado equivalente para evitar peligros.

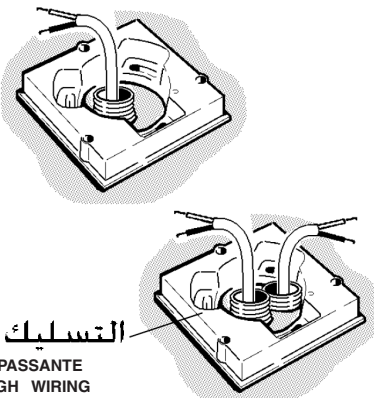

التسليك من خلال  
CABLAGGIO PASSANTE  
FEEDTHROUGH WIRING  
CABLEADO PASANTE

ملاحظة: عند التوصيل بالشبكة الكهربائية يجب استخدام تصنيف B511 - B512 أو ليزت عن  
توصيل من الفئة II التي تضمن حماية من الدرجة IP66 .

- I N.B.: Per il collegamento elettrico alla rete, servirsi dell'art. B511 - B512 o di altri dispositivi di connessione in classe II che garantiscano il grado di protezione IP66.  
GB N.B.: To connect to the mains, use art. B511 - B512 or other class II connection devices which guarantee an IP66 degree of protection.  
E NOTA: Para conexión eléctrica a la red, utilizar e art. B511 - B512 u otros dispositivos de conexión en clase II, para garantizar grado de protección IP66 .

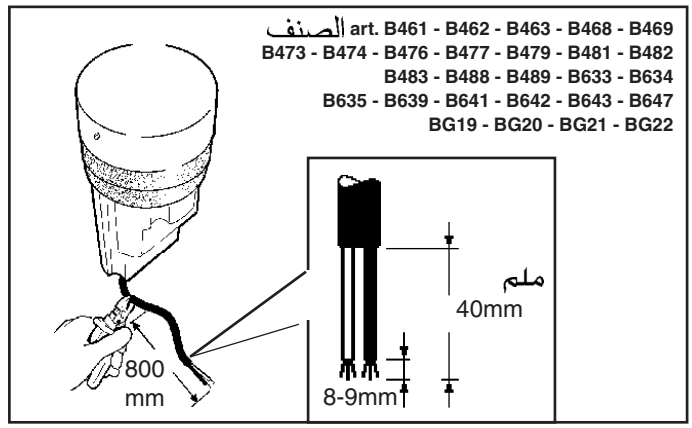

الاصنف art. B461 - B462 - B463 - B468 - B469  
B473 - B474 - B476 - B477 - B479 - B481 - B482  
B483 - B488 - B489 - B633 - B634  
B635 - B639 - B641 - B642 - B643 - B647  
BG19 - BG20 - BG21 - BG22

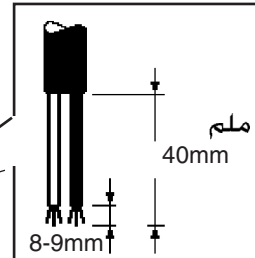
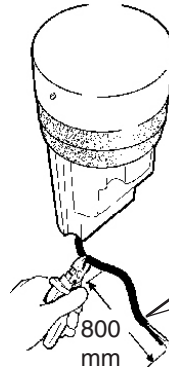

الاصنف  
ART.

عدد المنتجات القابلة للتوصيل / مقطع الكبل  
N° Prodotti collegabili / Sezione cavo  
No. of products that can be connected / Cable cross  
section.  
N° de productos a conectar / Sección del cable

	1,5 mm <sup>2</sup>	2,5 mm <sup>2</sup>	4 mm <sup>2</sup>
B466 - B486 - B638 - B646	25	37	45
B461 - B462 - B464 - B465 B481 - B482 - B484 - B485 B633 - B634 - B636 - B637 B641 - B642 - B644 - B645	50	75	97
B463 - B467 - B468 - B472 B483 - B487 - B488 - B492 B635 - B639 - B640 - B643 B647 - B648 - BG23 - BG24 BG25 - BG26 - BG27 - BG28 BG29 - BG30 - MR81 - MR82 MR83 - MR84 - MR85 MR86 - MR87 - MR88 BW60 - BW61 - BW62 BW63 - BW64 - BW65 BW74 - BW75 - BW76 BW77 - BW78 - BW79 BW66 - BW67 - BW68 BW69 - BW70 - BW71 BW80 - BW81 - BW82 BW83 - BW84 - BW85	97	134	173
B469 - B489 - BG19 - BG20 BG21 - BG22	120	160	200
B473 - B475 - B476 - B478	45	60	80
B474 - B477	107	147	190
B479 - B480	148	203	266

الاصنف ART.	art. B511	art. B512	art. BZG8	art. BZH0
B461 - B462 - B463 - B464 - B465 B466 - B467 - B473 - B474 - B475 B476 - B477 - B478 - B481 - B482 B483 - B484 - B485 - B486 - B487 B633 - B634 - B635 - B636 - B637 B638 - B641 - B642 - B643 - B644 B645 - B646 - MR81 - MR82 - MR83 MR84 - MR85 - MR86 - MR87 - MR88 BW62 - BW63 - BW64 - BW65 - BW68 BW69 - BW70 - BW71 - BW76 - BW77 BW78 - BW79 - BW81 - BW82 - BW83 BW84 - BW85	●			
B468 - B469 - B472 - B479 - B480 B488 - B489 - B492 - B639 - B640 B647 - B648 - BG19 - BG20 - BG21 BG22		●		
BG23 - BG24 - BG25 - BG26 - BG27 BG28 - BG29 - BG30 - BW60 - BW61 BW66 - BW67 - BW74 - BW75 - BW80 BW81			●	●

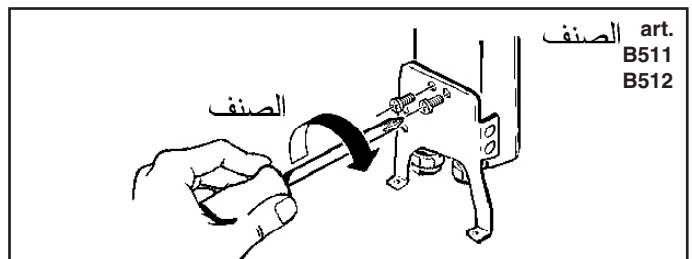

الاصنف art.  
B511  
B512

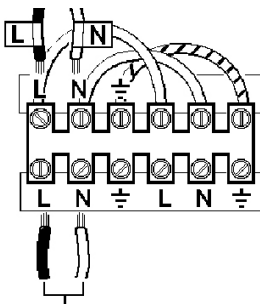
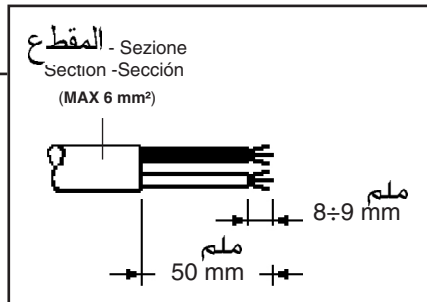
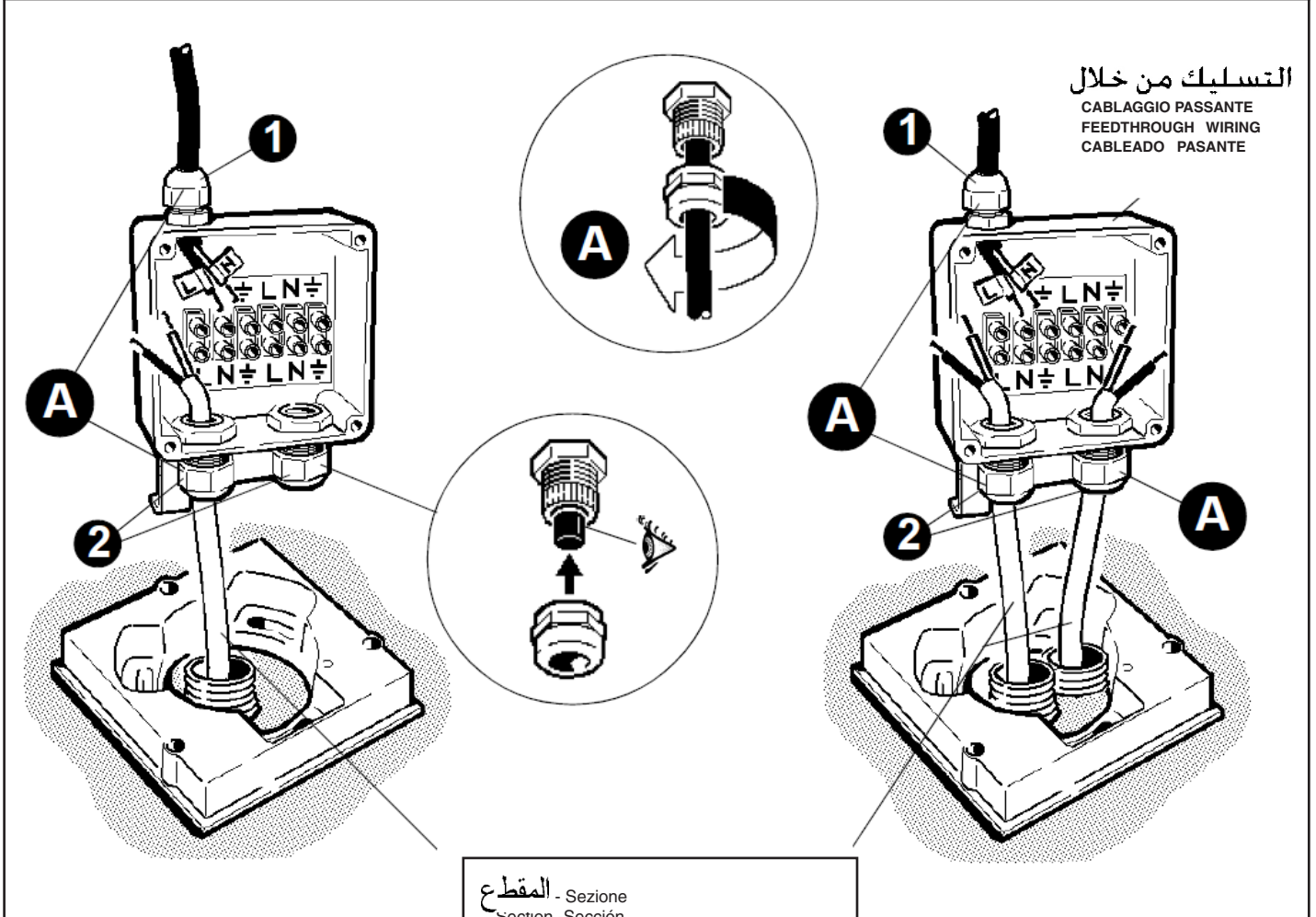
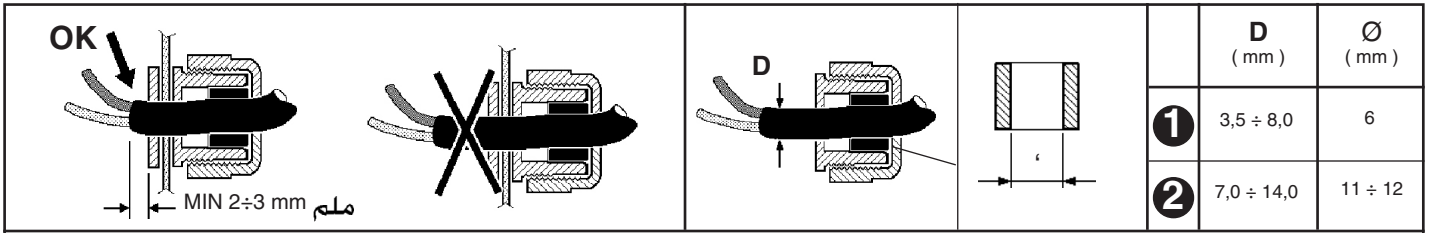

مصدر التيار  
ALIMENTAZIONE  
POWER SUPPLY  
CEBADOR

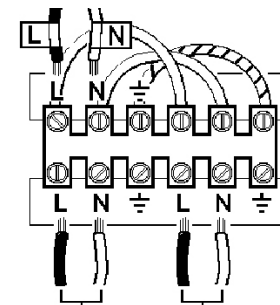

التسليك من خلال  
CABLAGGIO PASSANTE  
FEEDTHROUGH WIRING  
CABLEADO PASANTE

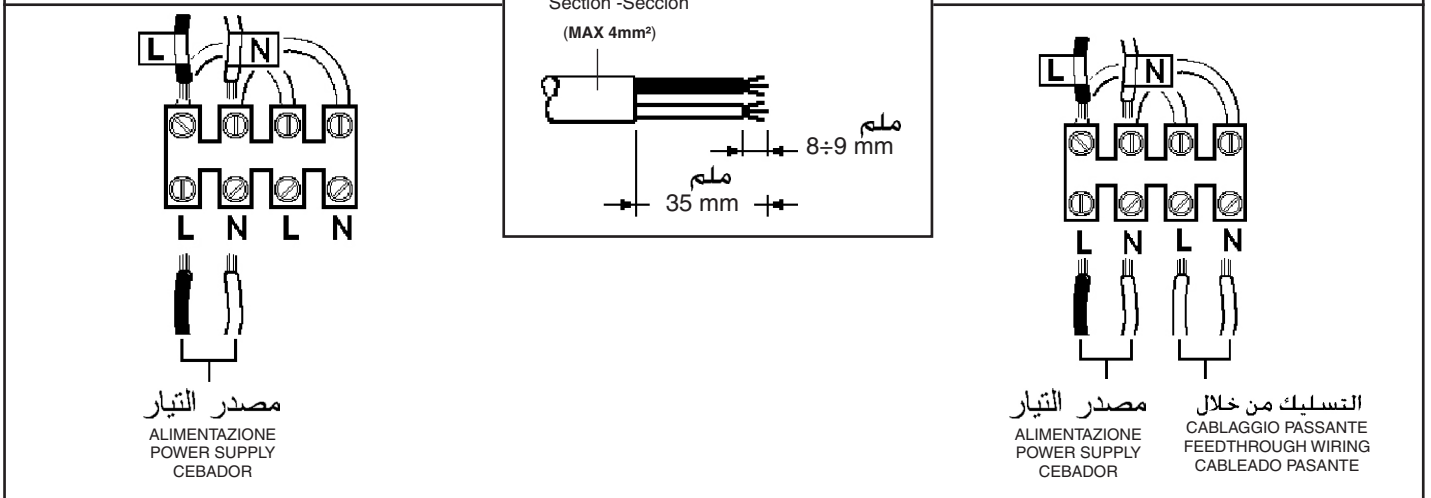
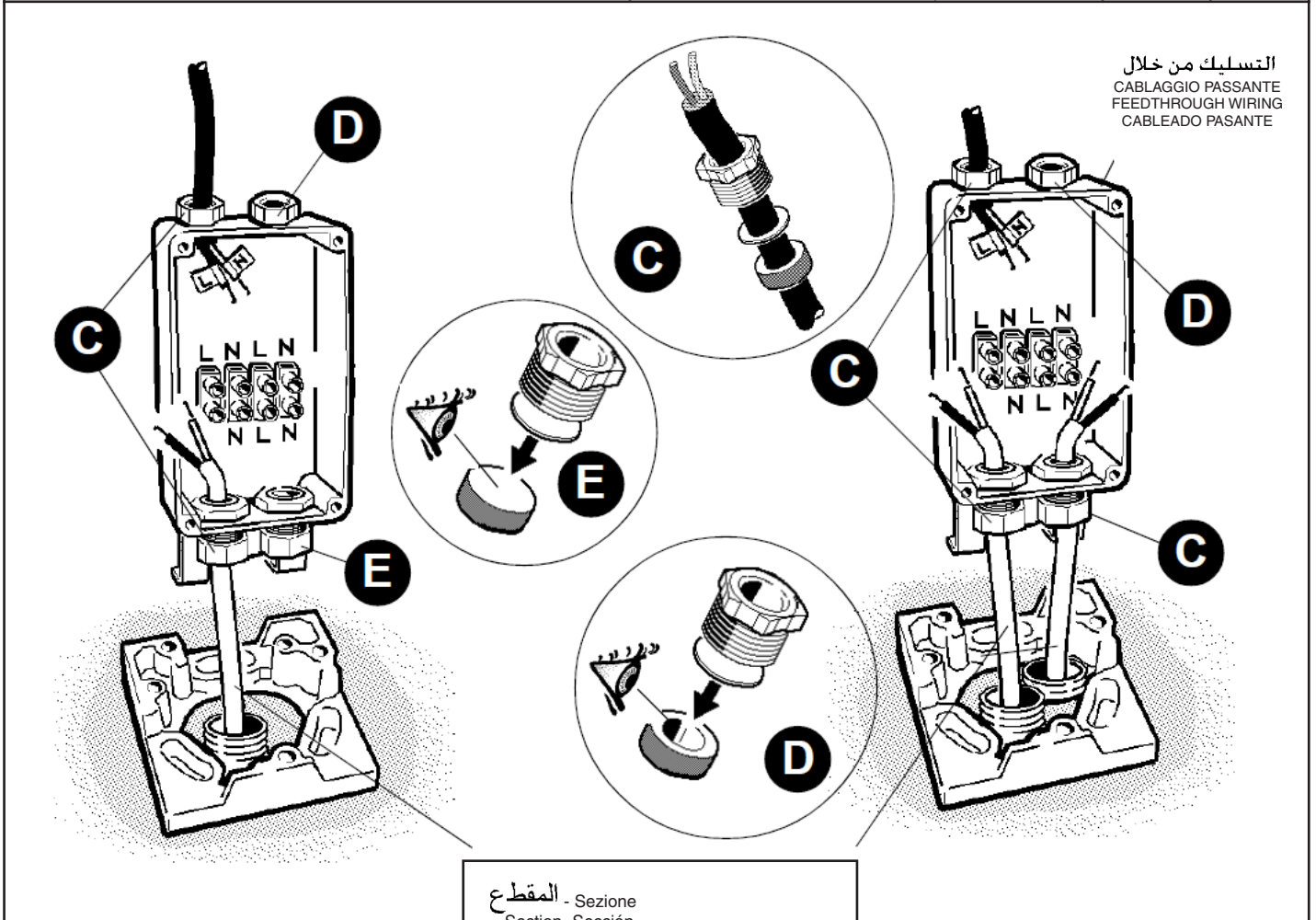
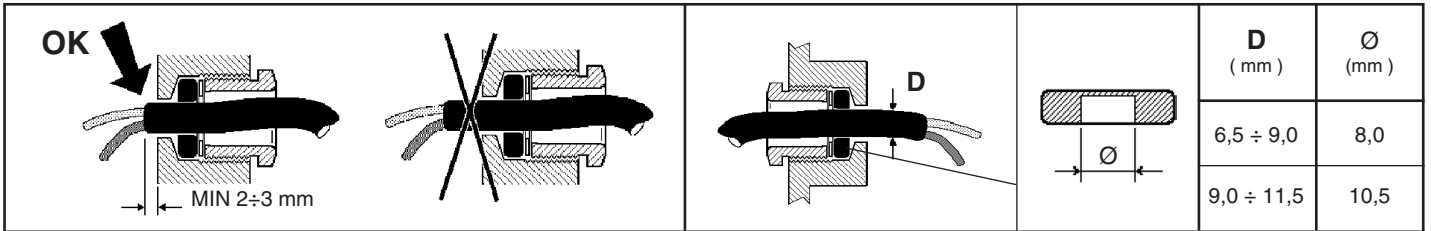

الصف art. B511  
B512

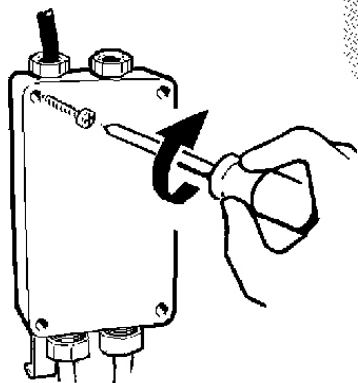
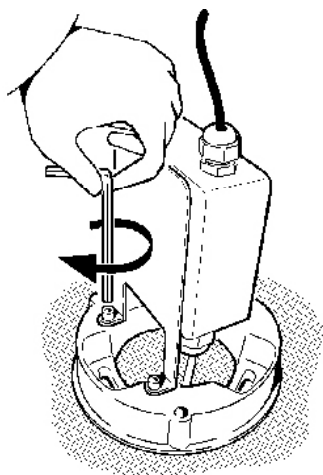

الصف art. BG23 - BG24 - BG25 - BG26 - BG27 - BG28  
BG29 - BG30 - BW60 - BW61 - BW66  
BW67 - BW74 - BW75 - BW80  
BW81

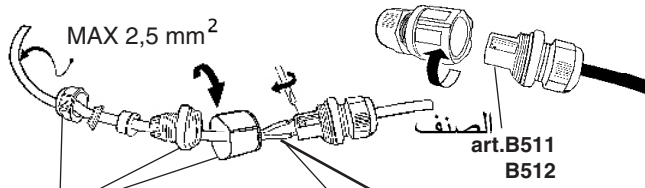

2,5 Nm

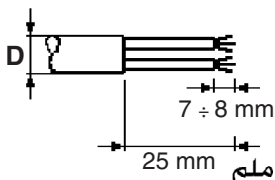
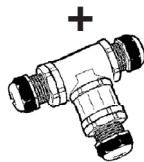

7 ÷ 8 mm

25 mm ملم

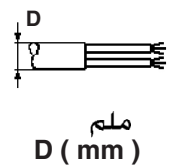

D (mm) ملم

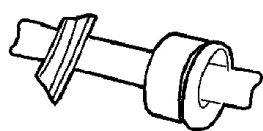

6,5 ÷ 8 mm ملم

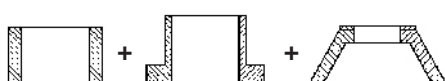

8 ÷ 9 mm ملم

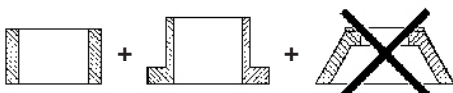

9 ÷ 13 mm ملم

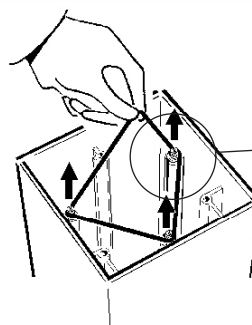
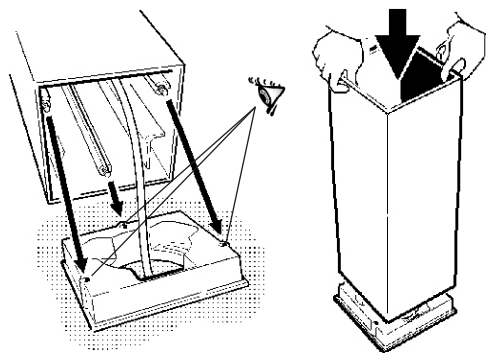

أزل الأشرطة المطاطية قبل استخدام المنتج. عر

- I Prima di utilizzare il prodotto asportare gli elastici.
- GB Remove the elastic bands before using the product.
- E Remover los elásticos antes de utilizar el producto.

ثبته بإحكام  
Serrare a fondo  
Tighten firmly  
Enrosacar en firm

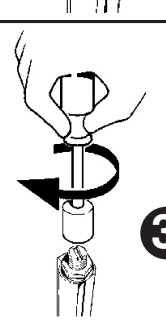
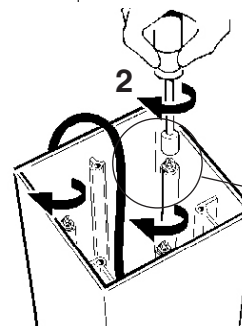
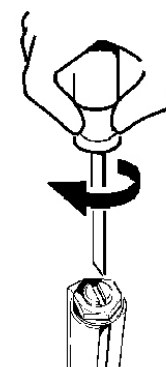
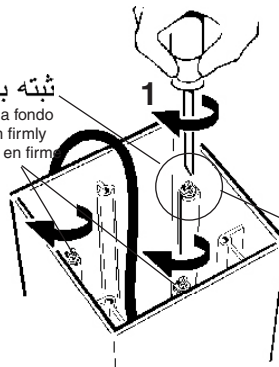

الصف ART.

3

B461 - B462 - B463 - B464 - B465 - B466 - B467 - B473  
B474 - B475 - B476 - B477 - B478 - B481 - B482 - B483  
B484 - B485 - B486 - B487 - B633 - B634 - B635 - B636  
B637 - B638 - B641 - B642 - B643 - B644 - B645 - B646  
BG23 - BG24 - BG25 - BG26 - BG27 - BG28 - BG29 - BG30  
MR81 - MR82 - MR83 - MR84 - MR85 - MR86 - MR87  
MR88 - BW60 - BW61 - BW62 - BW63 - BW64 - BW65  
BW74 - BW75 - BW76 - BW77 - BW78 - BW79 - BW66  
BW67 - BW68 - BW69 - BW70 - BW71 - BW80 - BW81  
BW82 - BW83 - BW84 - BW85

MAX 10 Nm

B468 - B469 - B472 - B479 - B480 - B488 - B489  
B492 - B639 - B640 - B647 - B648 - BG19 - BG20 - BG21  
BG22

MAX 5 Nm

جانب المشاة أو الدراجات الهوائية  
 LATO PEDONALE O CARRABILE  
 PEDESTRIAN OR VEHICULAR SIDE  
 LADO PEATONAL O VEHICULAR

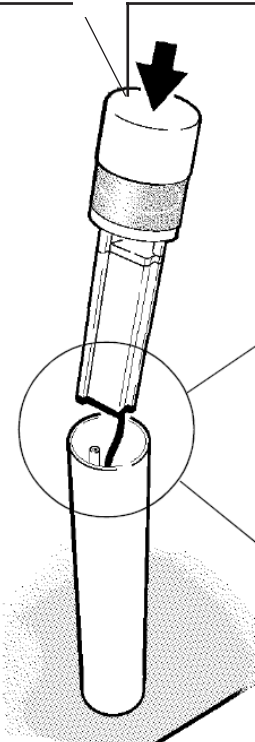
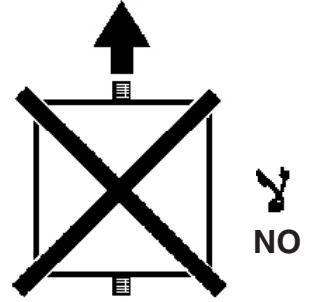
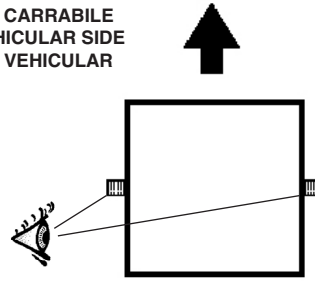
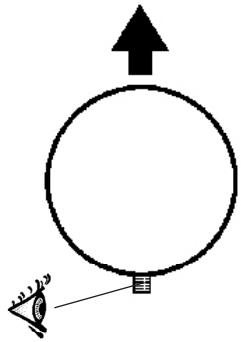

جانب المشاة أو الدراجات الهوائية  
 LATO PEDONALE O CARRABILE  
 PEDESTRIAN OR VEHICULAR SIDE  
 LADO PEATONAL O VEHICULAR

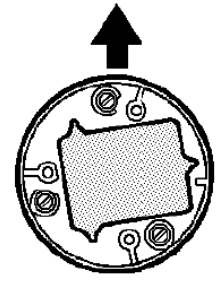

الصف  
 art. B468 - B469  
 B472 - B479  
 B480 - B639  
 B640  
 BG19 - BG20

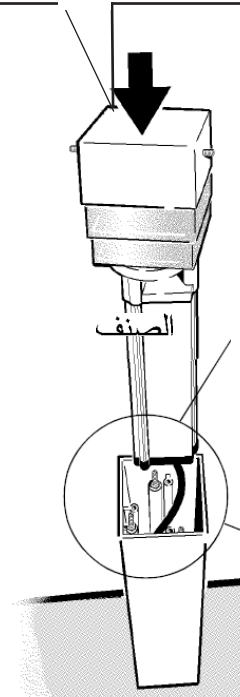

جانب المشاة أو الدراجات الهوائية  
 LATO PEDONALE O CARRABILE  
 PEDESTRIAN OR VEHICULAR SIDE  
 LADO PEATONAL O VEHICULAR

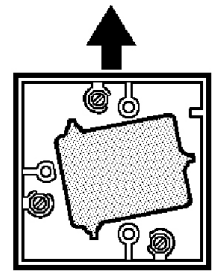

الصف  
 art. B488 - B489  
 B492 - B647  
 B648 - BG21  
 BG22

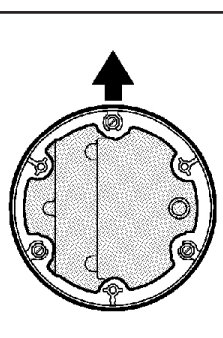

art. B461 - B462 - B463  
 B464 - B465 - B466  
 B467 - B473 - B474  
 B475 - B476 - B477  
 B478 - B633 - B634  
 B635 - B636 - B637  
 B638 - BG23 - BG24  
 BG25 - BG29 - MR81  
 MR82 - MR83 - MR84  
 BW60 - BW61 - BW62  
 BW63 - BW64 - BW65  
 BW74 - BW75 - BW76  
 BW77 - BW78 - BW79

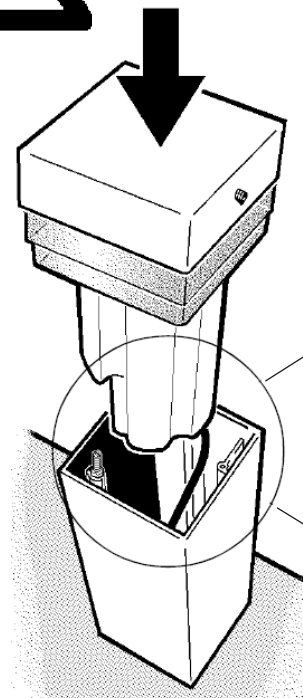
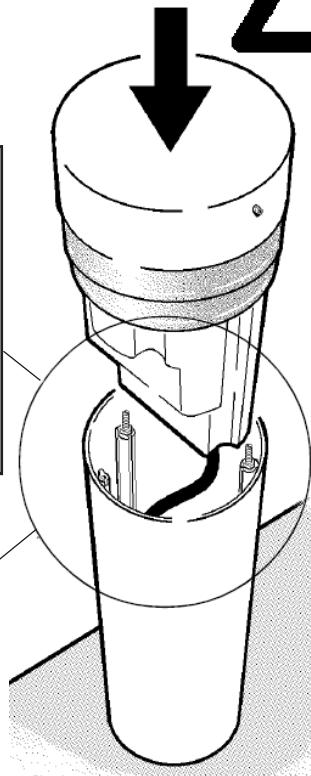

جانب المشاة أو الدراجات الهوائية  
 LATO PEDONALE O CARRABILE  
 PEDESTRIAN OR VEHICULAR SIDE  
 LADO PEATONAL O VEHICULAR

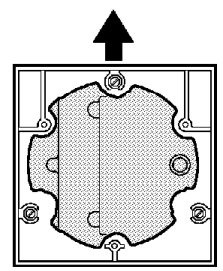

الصف  
 art. B481 - B482 - B483  
 B484 - B485 - B486  
 B487 - B641 - B642  
 B643 - B644 - B645  
 B646 - BG26 - BG27  
 BG28 - BG30 - MR85  
 MR86 - MR87 - MR88  
 BW66 - BW67 - BW68  
 BW69 - BW70 - BW71  
 BW80 - BW81 - BW82  
 BW83 - BW84 - BW85

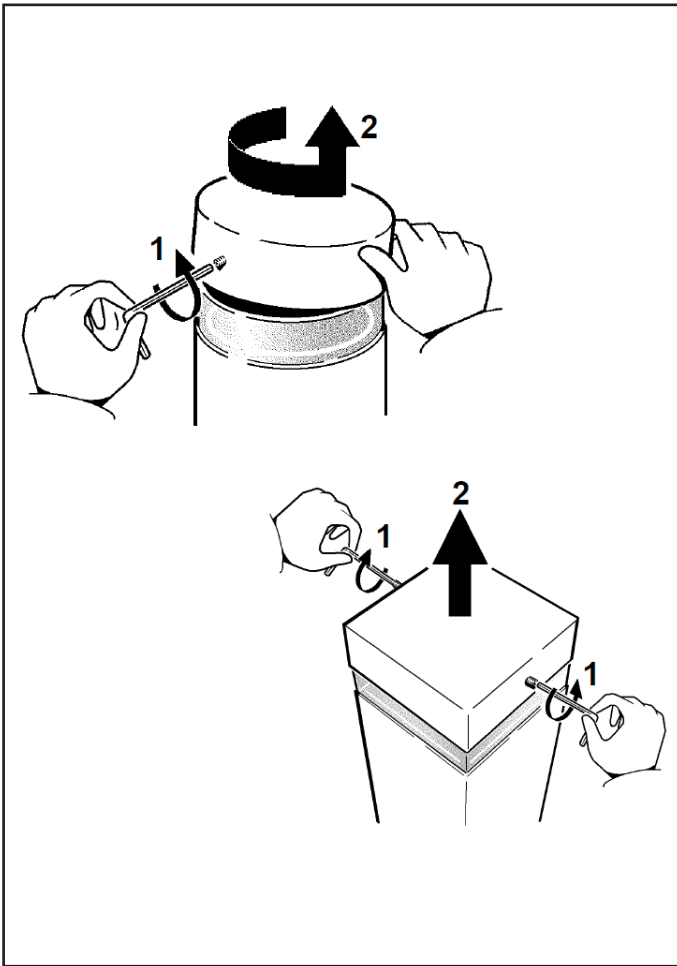

### LED VERSION

الصف

art. BG23 - BG24 - BG26 - BG27 - MR81 - MR82 - MR83  
 MR84 - MR85 - MR86 - MR87 - MR88 - BW60 - BW61  
 BW62 - BW63 - BW64 - BW65 - BW74 - BW75 - BW76  
 BW77 - BW78 - BW79 - BW66 - BW67 - BW68 - BW69  
 BW70 - BW71 - BW80 - BW81 - BW82 - BW83 - BW84  
 BW85 - B469 - B489 - BG19 - BG20 - BG21 - BG22

عر

يجب عدم اللمس المباشر للعاكس

I Evitare qualsiasi contatto diretto con il riflettore.

GB Avoid direct contact with reflector.

E Evitar cualquier contacto directo con el reflector.

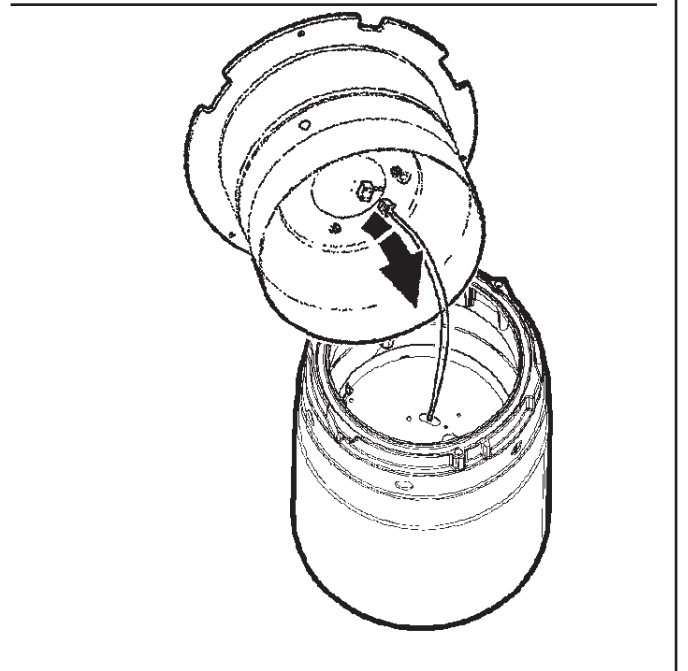
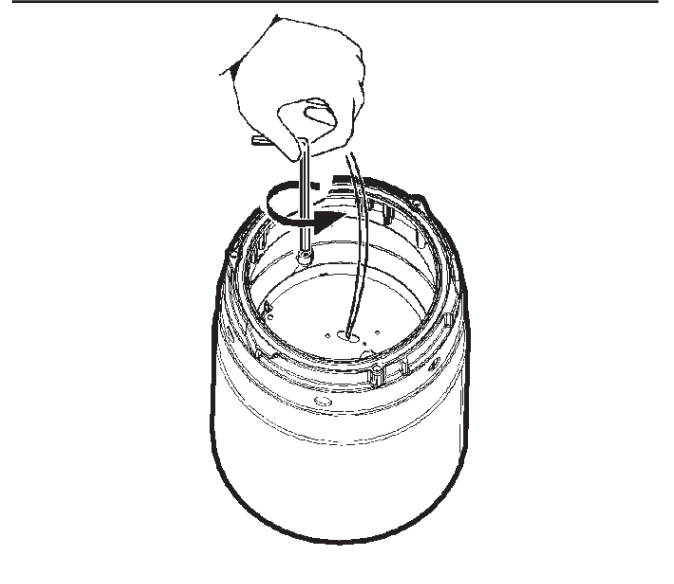
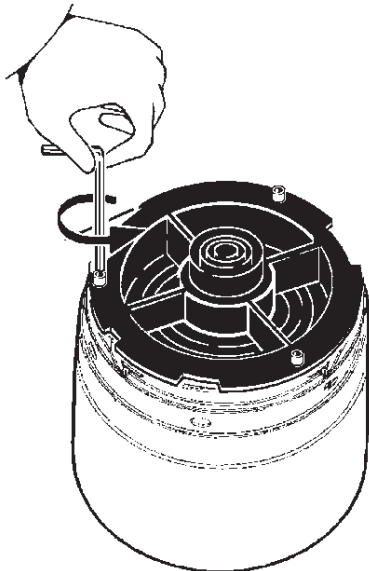

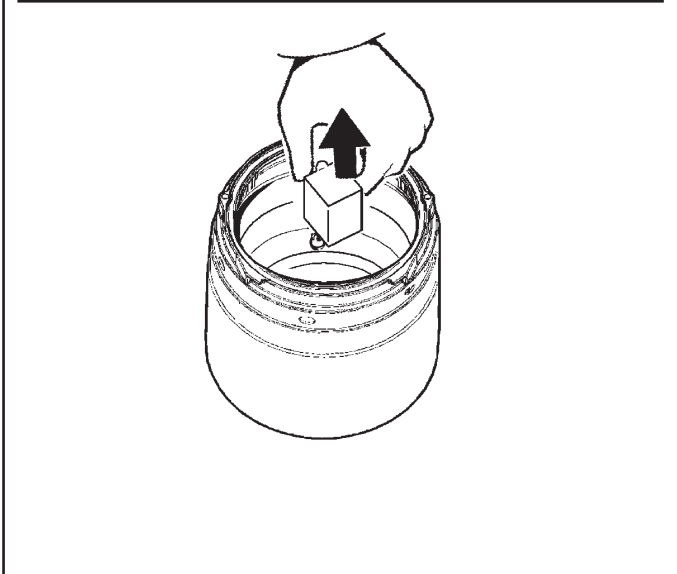
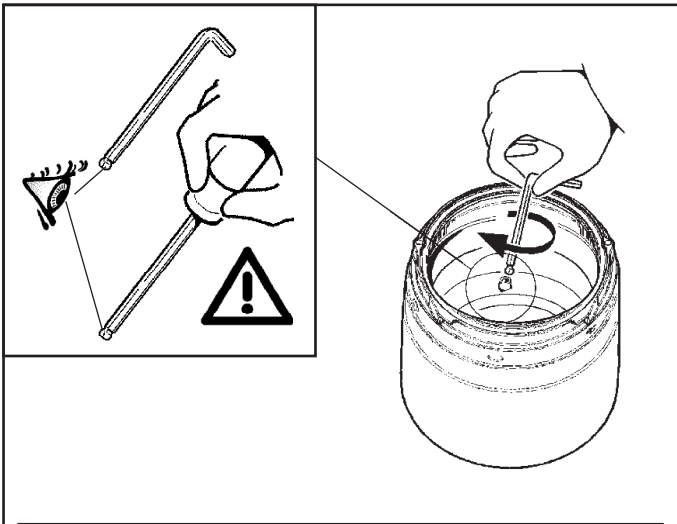

### HID VERSION

الصف

art. B461 - B462 - B463 - B464 - B465 - B466 - B467 - B473  
 B474 - B475 - B476 - B477 - B478 - B481 - B482 - B483  
 B484 - B485 - B486 - B487 - B633 - B634 - B635 - B636  
 B637 - B638 - B641 - B642 - B643 - B644 - B645 - B646  
 BG25 - BG28 - BG29 - BG30 - B468 - B472 - B479  
 B480 - B488 - B492 - B639 - B640 - B647 - B648

ع يجب عدم اللمس المباشر للعاكس

I Evitare qualsiasi contatto diretto con il riflettore.

GB Avoid direct contact with reflector.

E Evitar cualquier contacto directo con el reflector.

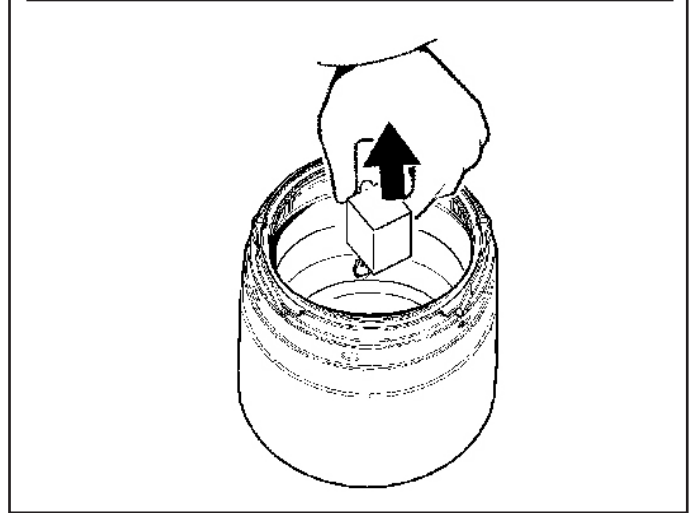
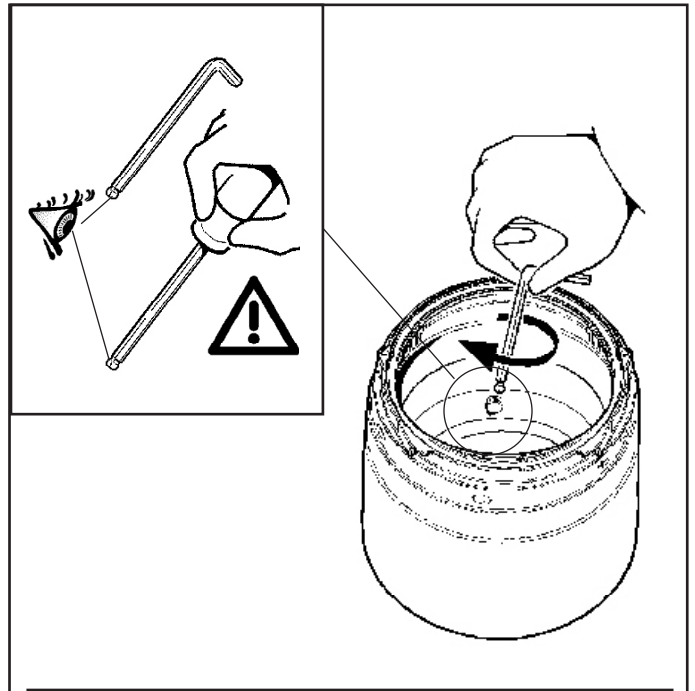
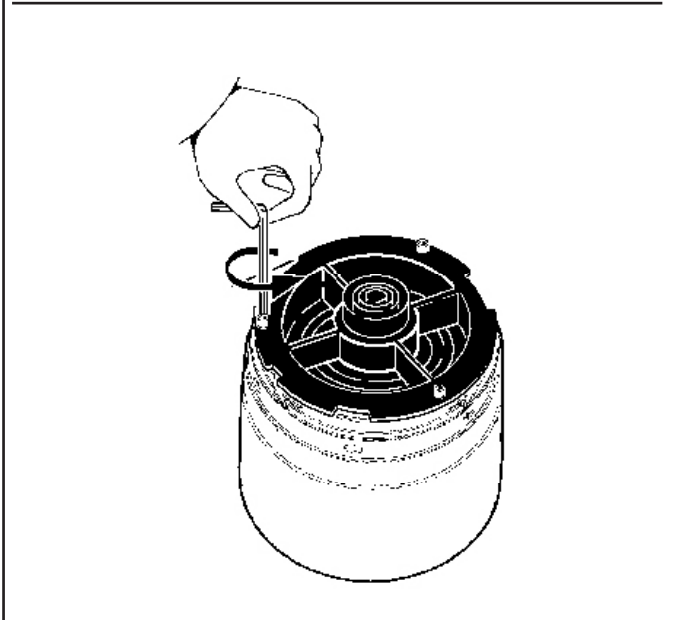

الصف B473

B474

B475

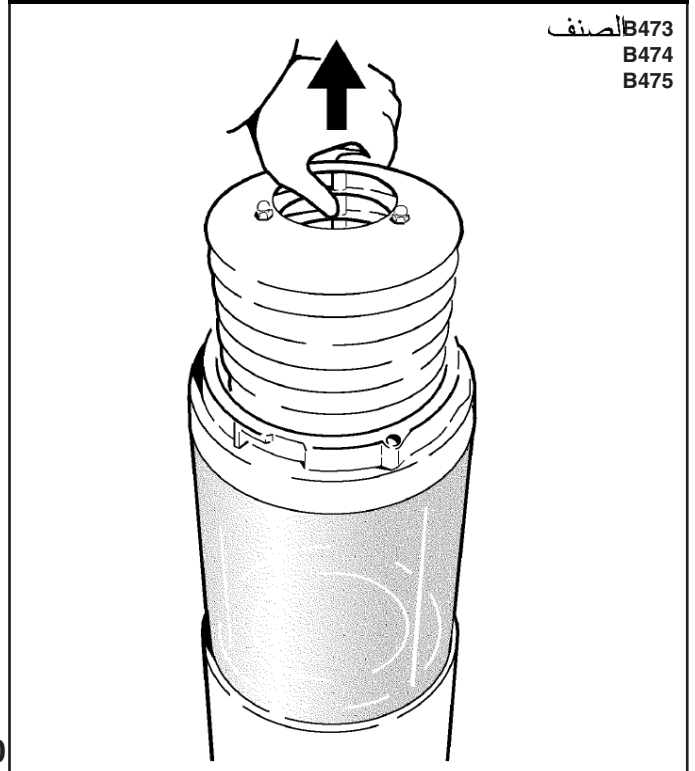



art. B461 - B462 - B464 - B465 - B466 - B481 - B482 - B484  
 الصنف B485 - B486 - B633 - B634 - B636 - B637 - B638 - B641  
 B642 - B644 - B645 - B646

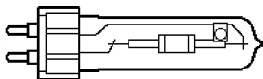

PHILIPS " CDM-T "  
 OSRAM " HCI-T "

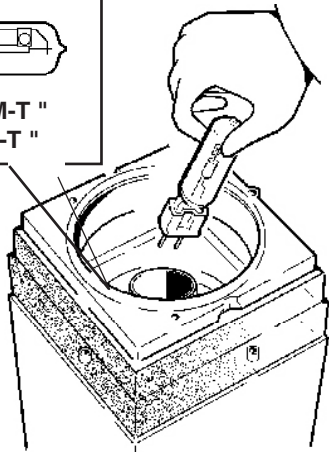

يتم الحصول على تغطية الضوء المصرح عنها من خلال استعمال المصابيح المبيّنة في الشكل. عر  
 ملاحظة: تحقق من دخول اللبنة حتى للنهاية في المقعر المتواجد على حامل لللمبة.

I Le prestazioni fotometriche dichiarate a catalogo sono garantite usando le lampade indicate in figura.  
 N.B.: Assicurarsi che la lampada sia inserita nella sede del portalampada fino in fondo.

GB The photometric performance indicated in the catalogue is guaranteed when using the shown in the figure.  
 N.B.: Make sure that the lamp is properly inserted all the way into the lamp holder.

E Las prestaciones fotométricas que declara el catálogo se garantizan al utilizar las lámparas indicadas en figura.  
 NOTA: Comprobar que la bombilla ha sido enroscada en el portalámparas hasta el tope.

الصنف art. B473  
 B474  
 B475

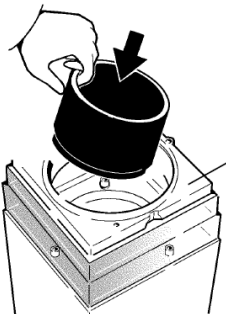
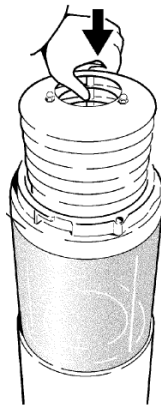

الصنف art. B633 - B634 - B635 - B636  
 B637 - B638 - B641 - B642  
 B643 - B644 - B645 - B646  
 BG29 - BG30

art. B481 - B482 - B483 - B484  
 B485 - B486 - B487 - B641  
 B642 - B642 - B644 - B645  
 B646 - BG26 - BG27 - BG28  
 BG30 - MR81 - MR82 - MR83  
 MR84 - MR85 - MR86 - MR87  
 MR88 - BW60 - BW61 - BW62  
 BW63 - BW64 - BW65 - BW74  
 BW75 - BW76 - BW77 - BW78  
 BW79 - BW66 - BW67 - BW68  
 BW69 - BW70 - BW71 - BW80  
 BW81 - BW82 - BW83 - BW84  
 BW85

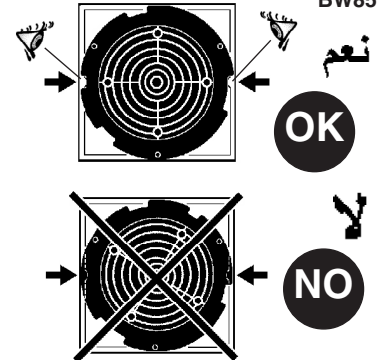
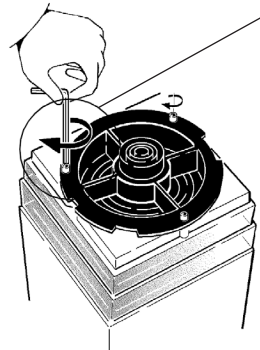

جانب المشاة أو الدراجات الهوائية  
 LATO PEDONALE O CARRABILE  
 PEDESTRIAN OR VEHICULAR SIDE  
 LADO PEATONAL O VEHICULAR

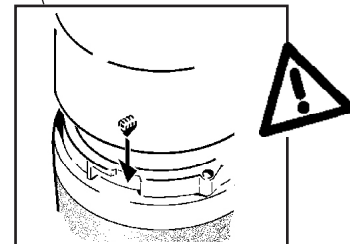
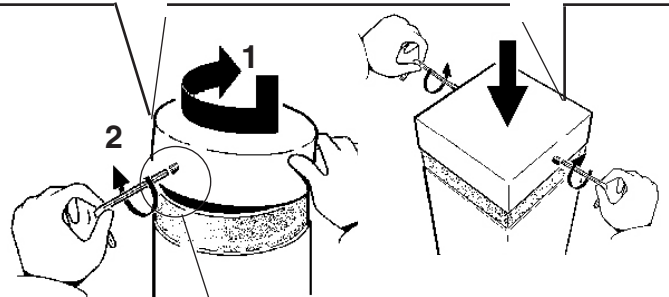
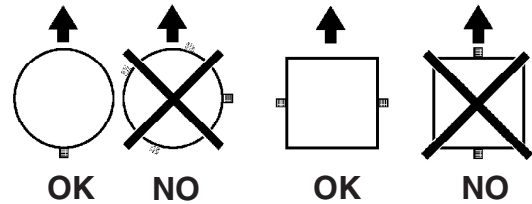

استبدال زجاج الحماية

SOSTITUZIONE DEL VETRO DI PROTEZIONE  
 REPLACING THE PROTECTIVE GLASS  
 REEMPLAZO DEL CRISTAL DE PROTECCION



لا يمكن استعمال المنتج في حالة كسر الزجاج، وبالتالي يجب الاتصال بالصانع لاستبداله. عر

I In caso di rottura del vetro il prodotto non può essere utilizzato, contattare il costruttore per la sua sostituzione.

GB Should the glass break, the product cannot be used and you should contact the manufacturer for its replacement.

E No utilizar el producto en caso de ruptura del vidrio y contactar el fabricante para la sustitución.

# + ART. XXXX

## ملحق

ACCESSORIO  
ACCESSORY  
ACCESORIO



الصف ART.	الصف art. B503	الصف art. B504	الصف art. B505	الصف art. B506	الصف art. B507	الصف art. B508
B461	●		●		●	
B462	●		●		●	
B463	●		●		●	
B464	●		●		●	
B465	●		●		●	
B466	●		●		●	
B467	●		●		●	
B468		●		●		●
B469		●		●		●
BG19		●		●		●
BG20		●		●		●
B472		●		●		●
B481	●		●		●	
B482	●		●		●	
B483	●		●		●	
B484	●		●		●	
B485	●		●		●	
B486	●		●		●	
B487	●		●		●	
B488		●		●		●
B489		●		●		●
BG21		●		●		●
BG22		●		●		●
B492		●		●		●
B633	●		●		●	
B634	●		●		●	
B635	●		●		●	
B636	●		●		●	
B637	●		●		●	
B638	●		●		●	
B639		●		●		●
B640		●		●		●
B641	●		●		●	
B642	●		●		●	
B643 - BG25	●		●		●	
B644 - BG28	●		●		●	
B645 - BG29	●		●		●	
B646 - BG30	●		●		●	
B647		●		●		●
B648		●		●		●

# + ART. XXXX

## ملحق

ACCESSORIO  
ACCESSORY  
ACCESORIO



الصف ART.	الصف art. X023	الصف art. X024	الصف art. X087	الصف art. X088
BG23 - BG24				
MR81 - MR82	●		●	
MR83 - MR84				
BG26 - BG27				
MR85 - MR86		●		●
MR87 - MR88				
BW60 - BW61				
BW62 - BW63				
BW64 - BW65	●		●	
BW74 - BW75				
BW76 - BW77				
BW78 - BW79				
BW66 - BW67				
BW68 - BW69				
BW70 - BW71		●		●
BW80 - BW81				
BW82 - BW83				
BW84 - BW85				

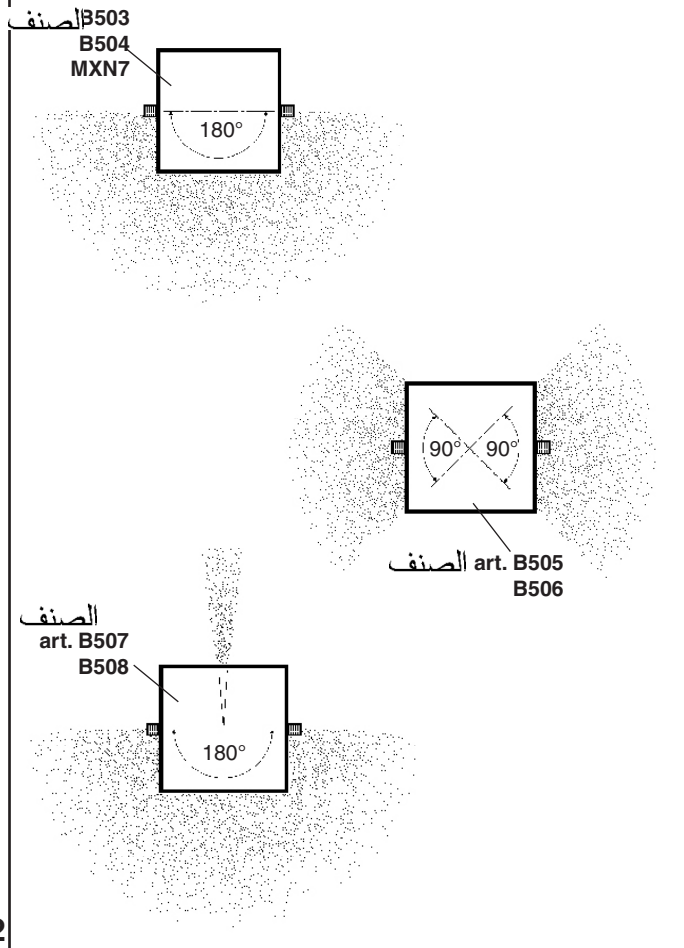

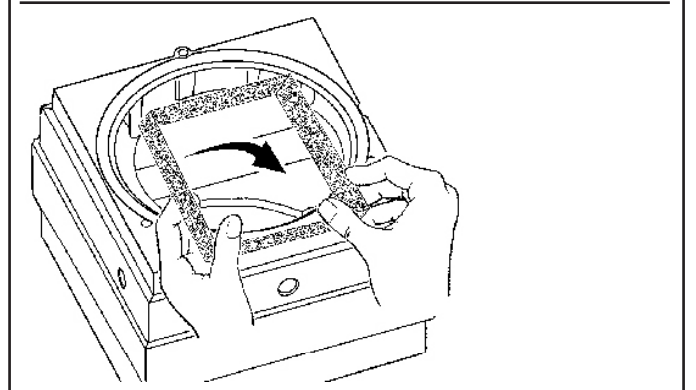
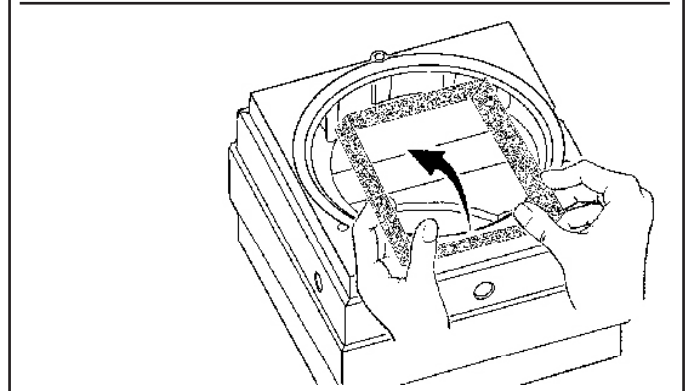
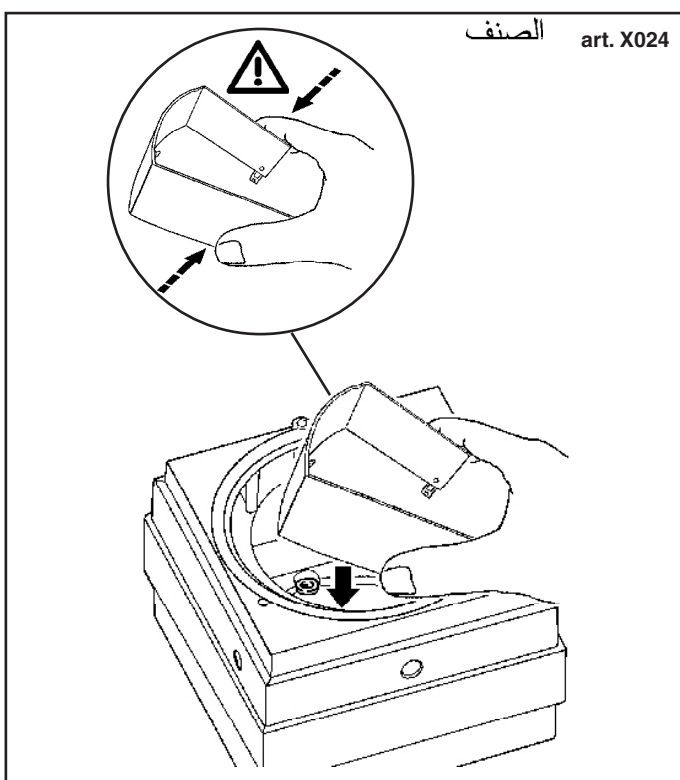
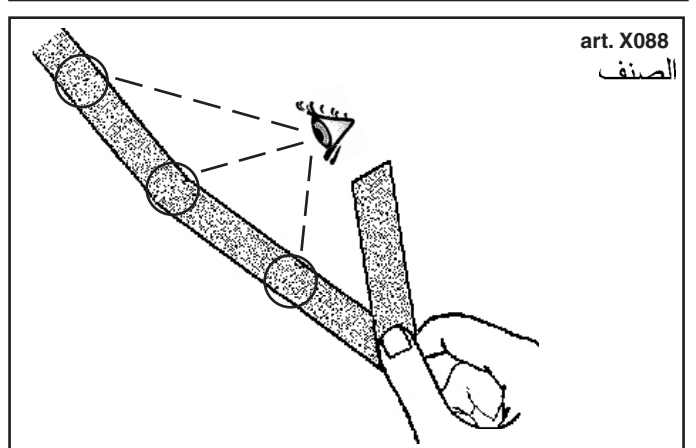
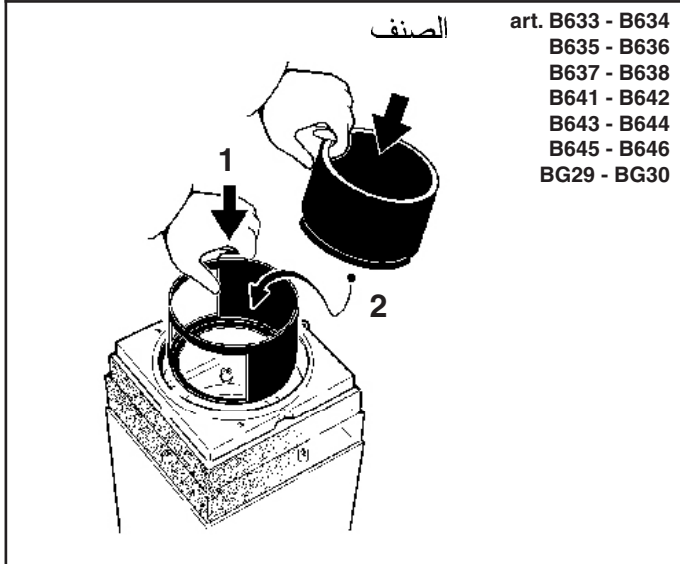
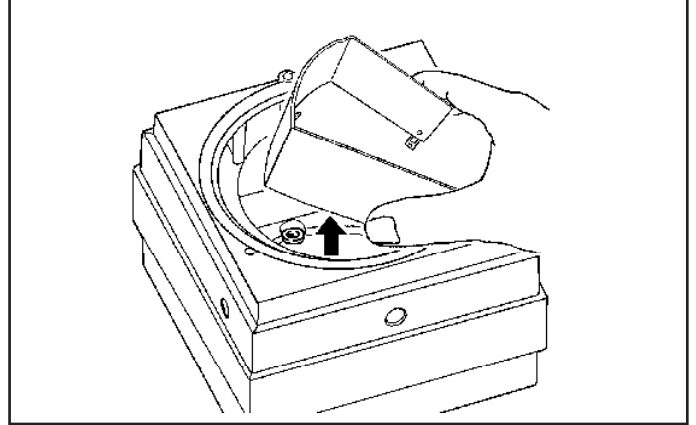
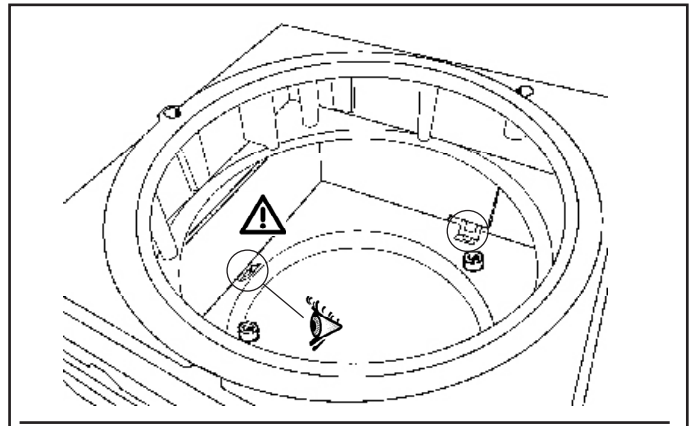
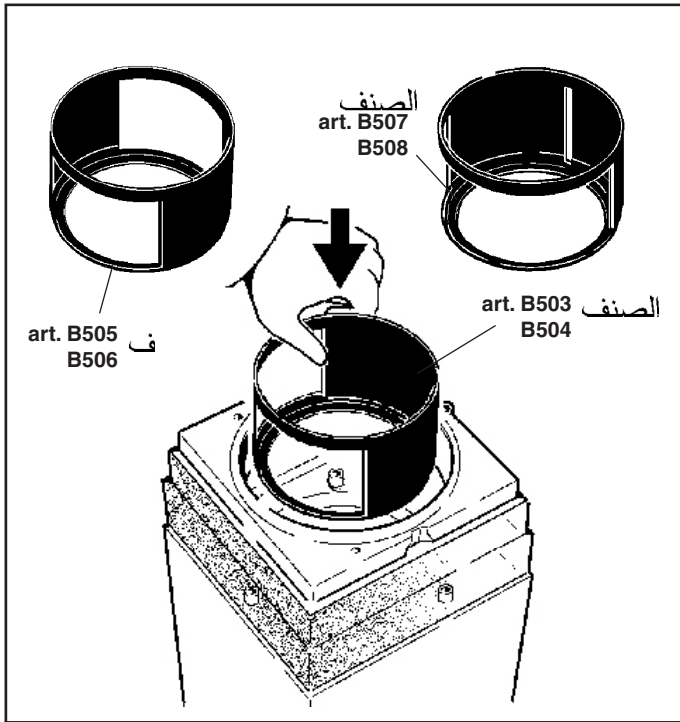

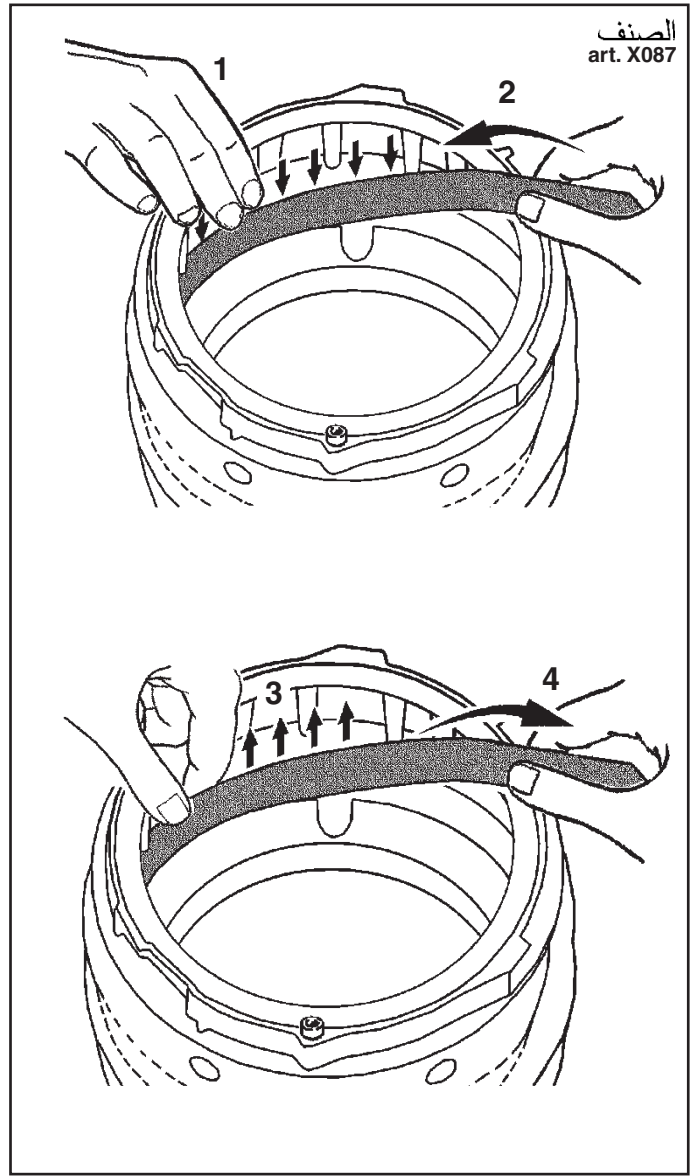
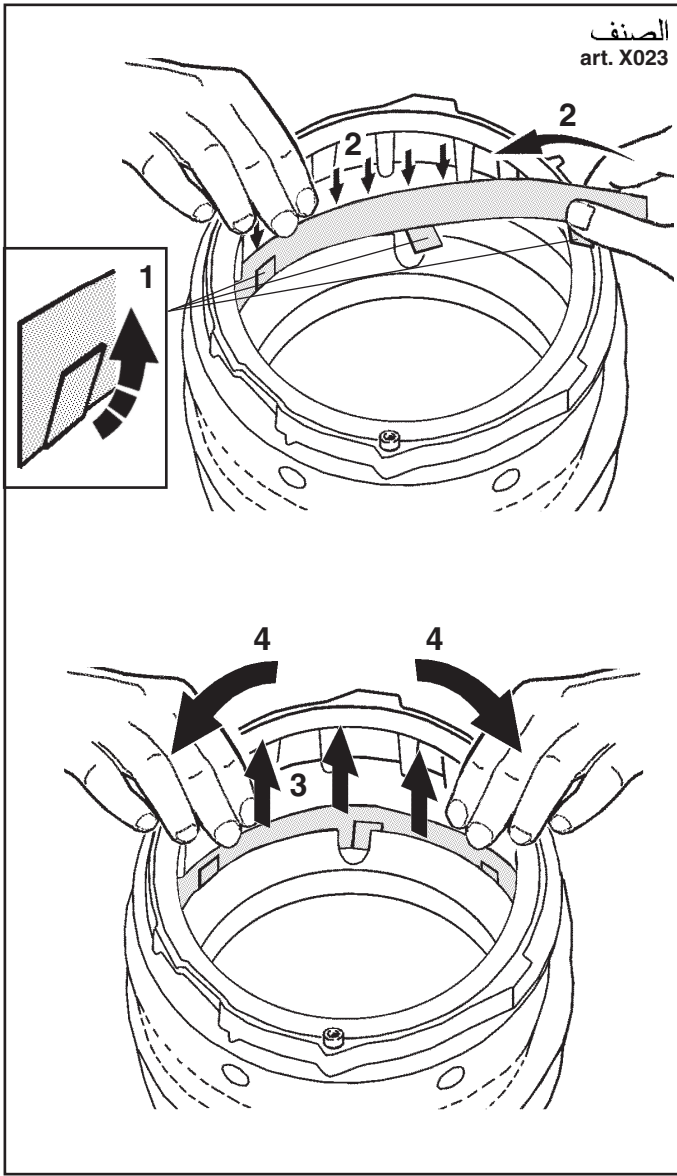

### استبدال الضوء LED

SOSTITUZIONE DEL LED  
REPLACING THE LED  
REEMPLAZO DEL LED

تثبيته: لاستبدال الضوء LED اتصل بشركة iGuzzini . عر

I N.B.: Per la sostituzione del LED contattare l'azienda iGuzzini.

GB N.B.: For information on LED replacement please contact iGuzzini.

E NOTA: Para sustituir el LED llame a la empresa iGuzzini.

1.154.544.00

IS00766/05

**SOSTITUZIONE DEL LED**  
**REPLACING THE LED**  
**REPLACEMENT DE LA LED**  
**AUSTAUSCHEN DER LED**  
**VERVANGEN VAN DE LED**  
**REEMPLAZO DEL LED**  
**UDSKIFTNING AF LYSDIODE**  
**BYTE AV LYSDIOD**  
**UTSKIFTING AV DEN LYSEMITTERENDE DIODEN**  
**ЗАМЕНА СИДа**  
**发光二极管替换**

**I N.B.:** Per la sostituzione del LED contattare l'azienda iGuzzini.

**GB N.B.:** For information on LED replacement please contact iGuzzini.

**F N.B.:** Pour procéder au remplacement de la LED, adressez-vous à la société iGuzzini.

**D N.B.:** Bezüglich des Austausches der LED kontaktieren Sie bitte die Firma iGuzzini.

**NL N.B.:** Voor het vervangen van de LED neemt u contact op met het bedrijf iGuzzini.

**E NOTA:** Para sustituir el LED llame a la empresa iGuzzini.

**DK N.B.:** For udskiftning af lysdioden, skal man kontakte iGuzzini.

**N N.B.:** For informasjon om skifte av LED, vennligst ta kontakt med iGuzzini.

**S OBS!** För byte av lysdioden, kontakta företaget iGuzzini.

**RUS ПРИМЕЧАНИЕ:**Для замены СИДов обращайтесь в компанию iGuzzini.

**CN 注意:** 如需LED更换的信息, 请联系iGuzzini.

**I** Gruppo di rischio 1, secondo norma **EN 62471: 2008**  
**GB** Risk Group: 1, in compliance with Standard **EN 62471: 2008**  
**FR** Groupe de risque 1, suivant la norme **EN 62471 : 2008**  
**DE** Risikogruppe 1, gemäß Vorschrift **EN 62471: 2008**  
**NL** Risicogroep 1, volgens de norm **EN 62471: 2008**  
**E** Grupo de riesgo 1, según norma **EN 62471: 2008**  
**DK** Faregruppe 1 i henhold til standarden **EN 62471: 2008**  
**N** Risikogruppe 1, i henhold til forskriften **EN 62471: 2008**  
**S** Riskgrupp 1, enligt standard **EN 62471: 2008**  
**RUS** GROUP РИСК 1 В СООТВЕТСТВИИ СО **EN 62471: 2008**

**CN** 风险组:1  
灯具和灯具系统的光生物学安全性符合标准 **EN 62471: 2008**

**iGuzzini**

1.154.544.00

IS00766/05

**SOSTITUZIONE DEL LED**  
**REPLACING THE LED**  
**REPLACEMENT DE LA LED**  
**AUSTAUSCHEN DER LED**  
**VERVANGEN VAN DE LED**  
**REEMPLAZO DEL LED**  
**UDSKIFTNING AF LYSDIODE**  
**BYTE AV LYSDIOD**  
**UTSKIFTING AV DEN LYSEMITTERENDE DIODEN**  
**ЗАМЕНА СИДа**  
**发光二极管替换**

**I N.B.:** Per la sostituzione del LED contattare l'azienda iGuzzini.

**GB N.B.:** For information on LED replacement please contact iGuzzini.

**F N.B.:** Pour procéder au remplacement de la LED, adressez-vous à la société iGuzzini.

**D N.B.:** Bezüglich des Austausches der LED kontaktieren Sie bitte die Firma iGuzzini.

**NL N.B.:** Voor het vervangen van de LED neemt u contact op met het bedrijf iGuzzini.

**E NOTA:** Para sustituir el LED llame a la empresa iGuzzini.

**DK N.B.:** For udskiftning af lysdioden, skal man kontakte iGuzzini.

**N N.B.:** For informasjon om skifte av LED, vennligst ta kontakt med iGuzzini.

**S OBS!** För byte av lysdioden, kontakta företaget iGuzzini.

**RUS ПРИМЕЧАНИЕ:**Для замены СИДов обращайтесь в компанию iGuzzini.

**CN 注意:** 如需LED更换的信息, 请联系iGuzzini.

**I** Gruppo di rischio 1, secondo norma **EN 62471: 2008**  
**GB** Risk Group: 1, in compliance with Standard **EN 62471: 2008**  
**FR** Groupe de risque 1, suivant la norme **EN 62471 : 2008**  
**DE** Risikogruppe 1, gemäß Vorschrift **EN 62471: 2008**  
**NL** Risicogroep 1, volgens de norm **EN 62471: 2008**  
**E** Grupo de riesgo 1, según norma **EN 62471: 2008**  
**DK** Faregruppe 1 i henhold til standarden **EN 62471: 2008**  
**N** Risikogruppe 1, i henhold til forskriften **EN 62471: 2008**  
**S** Riskgrupp 1, enligt standard **EN 62471: 2008**  
**RUS** GROUP РИСК 1 В СООТВЕТСТВИИ СО **EN 62471: 2008**

**CN** 风险组:1  
灯具和灯具系统的光生物学安全性符合标准 **EN 62471: 2008**

**iGuzzini**

1.154.544.00

IS00766/05

**SOSTITUZIONE DEL LED**  
**REPLACING THE LED**  
**REPLACEMENT DE LA LED**  
**AUSTAUSCHEN DER LED**  
**VERVANGEN VAN DE LED**  
**REEMPLAZO DEL LED**  
**UDSKIFTNING AF LYSDIODE**  
**BYTE AV LYSDIOD**  
**UTSKIFTING AV DEN LYSEMITTERENDE DIODEN**  
**ЗАМЕНА СИДа**  
**发光二极管替换**

**I N.B.:** Per la sostituzione del LED contattare l'azienda iGuzzini.

**GB N.B.:** For information on LED replacement please contact iGuzzini.

**F N.B.:** Pour procéder au remplacement de la LED, adressez-vous à la société iGuzzini.

**D N.B.:** Bezüglich des Austausches der LED kontaktieren Sie bitte die Firma iGuzzini.

**NL N.B.:** Voor het vervangen van de LED neemt u contact op met het bedrijf iGuzzini.

**E NOTA:** Para sustituir el LED llame a la empresa iGuzzini.

**DK N.B.:** For udskiftning af lysdioden, skal man kontakte iGuzzini.

**N N.B.:** For informasjon om skifte av LED, vennligst ta kontakt med iGuzzini.

**S OBS!** För byte av lysdioden, kontakta företaget iGuzzini.

**RUS ПРИМЕЧАНИЕ:**Для замены СИДов обращайтесь в компанию iGuzzini.

**CN 注意:** 如需LED更换的信息, 请联系iGuzzini.

**I** Gruppo di rischio 1, secondo norma **EN 62471: 2008**  
**GB** Risk Group: 1, in compliance with Standard **EN 62471: 2008**  
**FR** Groupe de risque 1, suivant la norme **EN 62471 : 2008**  
**DE** Risikogruppe 1, gemäß Vorschrift **EN 62471: 2008**  
**NL** Risicogroep 1, volgens de norm **EN 62471: 2008**  
**E** Grupo de riesgo 1, según norma **EN 62471: 2008**  
**DK** Faregruppe 1 i henhold til standarden **EN 62471: 2008**  
**N** Risikogruppe 1, i henhold til forskriften **EN 62471: 2008**  
**S** Riskgrupp 1, enligt standard **EN 62471: 2008**  
**RUS** GROUP РИСК 1 В СООТВЕТСТВИИ СО **EN 62471: 2008**

**CN** 风险组:1  
灯具和灯具系统的光生物学安全性符合标准 **EN 62471: 2008**

**iGuzzini**

2.519.554.01 IS08596/01			<b>iGuzini</b>
ART.	fattore di potenza power factor facteur de puissance Leistungsfaktor vermogensfactor factor de potencia effektfaktor effektfaktor effektfaktor фактор мощности 功率因数	corrente assorbita absorbed current courant absorbé Stromaufnahme stroomopname corriente absorbida absorberet strøm absorbert strøm tillförd ström поглощаемая мощность 电源电流 (A)	
BW60 - BW61 - BW62 - BW63 BW64 - BW65 - BW66 - BW67 BW68 - BW69 - BW70 - BW71	0,90	0,06	
BW74 - BW75 - BW76 - BW77 BW78 - BW79 - BW80 - BW81 BW82 - BW83 - BW84 - BW85	0,86	0,29	

2.519.554.01 IS08596/01			<b>iGuzini</b>
ART.	fattore di potenza power factor facteur de puissance Leistungsfaktor vermogensfactor factor de potencia effektfaktor effektfaktor effektfaktor фактор мощности 功率因数	corrente assorbita absorbed current courant absorbé Stromaufnahme stroomopname corriente absorbida absorberet strøm absorbert strøm tillförd ström поглощаемая мощность 电源电流 (A)	
BW60 - BW61 - BW62 - BW63 BW64 - BW65 - BW66 - BW67 BW68 - BW69 - BW70 - BW71	0,90	0,06	
BW74 - BW75 - BW76 - BW77 BW78 - BW79 - BW80 - BW81 BW82 - BW83 - BW84 - BW85	0,86	0,29	

2.519.554.01 IS08596/01			<b>iGuzini</b>
ART.	fattore di potenza power factor facteur de puissance Leistungsfaktor vermogensfactor factor de potencia effektfaktor effektfaktor effektfaktor фактор мощности 功率因数	corrente assorbita absorbed current courant absorbé Stromaufnahme stroomopname corriente absorbida absorberet strøm absorbert strøm tillförd ström поглощаемая мощность 电源电流 (A)	
BW60 - BW61 - BW62 - BW63 BW64 - BW65 - BW66 - BW67 BW68 - BW69 - BW70 - BW71	0,90	0,06	
BW74 - BW75 - BW76 - BW77 BW78 - BW79 - BW80 - BW81 BW82 - BW83 - BW84 - BW85	0,86	0,29	

2.519.554.01 IS08596/01			<b>iGuzini</b>
ART.	fattore di potenza power factor facteur de puissance Leistungsfaktor vermogensfactor factor de potencia effektfaktor effektfaktor effektfaktor фактор мощности 功率因数	corrente assorbita absorbed current courant absorbé Stromaufnahme stroomopname corriente absorbida absorberet strøm absorbert strøm tillförd ström поглощаемая мощность 电源电流 (A)	
BW60 - BW61 - BW62 - BW63 BW64 - BW65 - BW66 - BW67 BW68 - BW69 - BW70 - BW71	0,90	0,06	
BW74 - BW75 - BW76 - BW77 BW78 - BW79 - BW80 - BW81 BW82 - BW83 - BW84 - BW85	0,86	0,29	

2.519.554.01 IS08596/01			<b>iGuzini</b>
ART.	fattore di potenza power factor facteur de puissance Leistungsfaktor vermogensfactor factor de potencia effektfaktor effektfaktor effektfaktor фактор мощности 功率因数	corrente assorbita absorbed current courant absorbé Stromaufnahme stroomopname corriente absorbida absorberet strøm absorbert strøm tillförd ström поглощаемая мощность 电源电流 (A)	
BW60 - BW61 - BW62 - BW63 BW64 - BW65 - BW66 - BW67 BW68 - BW69 - BW70 - BW71	0,90	0,06	
BW74 - BW75 - BW76 - BW77 BW78 - BW79 - BW80 - BW81 BW82 - BW83 - BW84 - BW85	0,86	0,29	

2.519.554.01 IS08596/01			<b>iGuzini</b>
ART.	fattore di potenza power factor facteur de puissance Leistungsfaktor vermogensfactor factor de potencia effektfaktor effektfaktor effektfaktor фактор мощности 功率因数	corrente assorbita absorbed current courant absorbé Stromaufnahme stroomopname corriente absorbida absorberet strøm absorbert strøm tillförd ström поглощаемая мощность 电源电流 (A)	
BW60 - BW61 - BW62 - BW63 BW64 - BW65 - BW66 - BW67 BW68 - BW69 - BW70 - BW71	0,90	0,06	
BW74 - BW75 - BW76 - BW77 BW78 - BW79 - BW80 - BW81 BW82 - BW83 - BW84 - BW85	0,86	0,29	

I PERIODO GIORNALIERO DI ACCENSIONE AMMESSO  
GB ALLOWED DAILY OPERATION PERIOD  
F DURÉE QUOTIDIENNE D'ALLUMAGE ADMISSIBLE  
D ERLAUBTE TÄGLICHE EINSCHALTDAUER  
NL DAGELIJKSE ONTSTEKINGSPERIODE TOEGESTAAN  
E PERIODO DIARIO DE ENCENDIDO PERMITIDO  
DK TILLADT TIDSRUM FOR DAGLIG TÆNDING  
N TILLÄTT TENNINGSTID PR. DAG  
S TILLÄTEN DAGLIG PERIOD SOM PRODUKTEN KAN VARA TÄND  
RUS ЕЖЕДНЕВНАЯ ДОПУСТИМАЯ ПРОДОЛЖИТЕЛЬНОСТЬ РАБОТЫ  
CN 允许的日常工作周期

iGuzzini

1.154.627.01  
IS09175/01

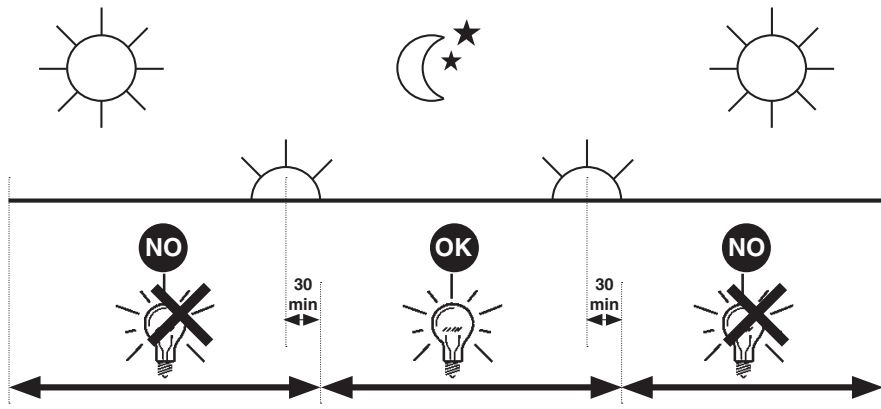

I PERIODO GIORNALIERO DI ACCENSIONE AMMESSO  
GB ALLOWED DAILY OPERATION PERIOD  
F DURÉE QUOTIDIENNE D'ALLUMAGE ADMISSIBLE  
D ERLAUBTE TÄGLICHE EINSCHALTDAUER  
NL DAGELIJKSE ONTSTEKINGSPERIODE TOEGESTAAN  
E PERIODO DIARIO DE ENCENDIDO PERMITIDO  
DK TILLADT TIDSRUM FOR DAGLIG TÆNDING  
N TILLÄTT TENNINGSTID PR. DAG  
S TILLÄTEN DAGLIG PERIOD SOM PRODUKTEN KAN VARA TÄND  
RUS ЕЖЕДНЕВНАЯ ДОПУСТИМАЯ ПРОДОЛЖИТЕЛЬНОСТЬ РАБОТЫ  
CN 允许的日常工作周期

iGuzzini

1.154.627.01  
IS09175/01

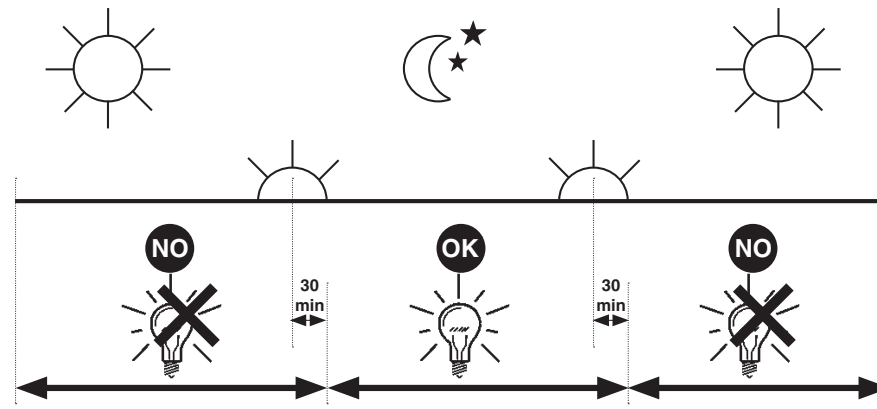

I PERIODO GIORNALIERO DI ACCENSIONE AMMESSO  
GB ALLOWED DAILY OPERATION PERIOD  
F DURÉE QUOTIDIENNE D'ALLUMAGE ADMISSIBLE  
D ERLAUBTE TÄGLICHE EINSCHALTDAUER  
NL DAGELIJKSE ONTSTEKINGSPERIODE TOEGESTAAN  
E PERIODO DIARIO DE ENCENDIDO PERMITIDO  
DK TILLADT TIDSRUM FOR DAGLIG TÆNDING  
N TILLÄTT TENNINGSTID PR. DAG  
S TILLÄTEN DAGLIG PERIOD SOM PRODUKTEN KAN VARA TÄND  
RUS ЕЖЕДНЕВНАЯ ДОПУСТИМАЯ ПРОДОЛЖИТЕЛЬНОСТЬ РАБОТЫ  
CN 允许的日常工作周期

iGuzzini

1.154.627.01  
IS09175/01

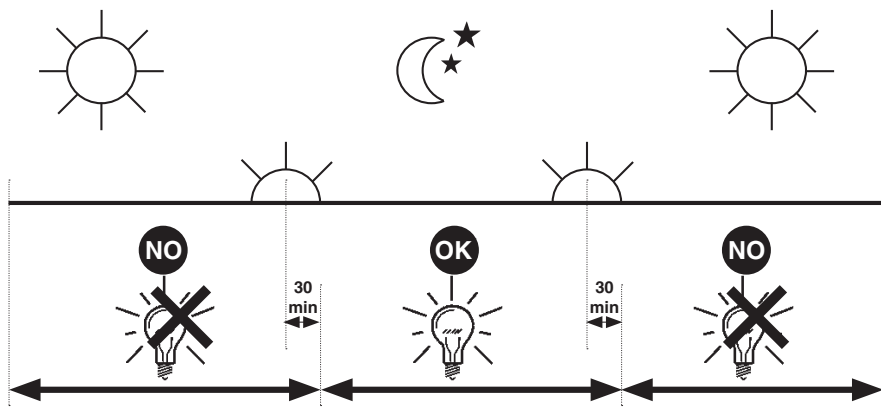

I PERIODO GIORNALIERO DI ACCENSIONE AMMESSO  
GB ALLOWED DAILY OPERATION PERIOD  
F DURÉE QUOTIDIENNE D'ALLUMAGE ADMISSIBLE  
D ERLAUBTE TÄGLICHE EINSCHALTDAUER  
NL DAGELIJKSE ONTSTEKINGSPERIODE TOEGESTAAN  
E PERIODO DIARIO DE ENCENDIDO PERMITIDO  
DK TILLADT TIDSRUM FOR DAGLIG TÆNDING  
N TILLÄTT TENNINGSTID PR. DAG  
S TILLÄTEN DAGLIG PERIOD SOM PRODUKTEN KAN VARA TÄND  
RUS ЕЖЕДНЕВНАЯ ДОПУСТИМАЯ ПРОДОЛЖИТЕЛЬНОСТЬ РАБОТЫ  
CN 允许的日常工作周期

iGuzzini

1.154.627.01  
IS09175/01

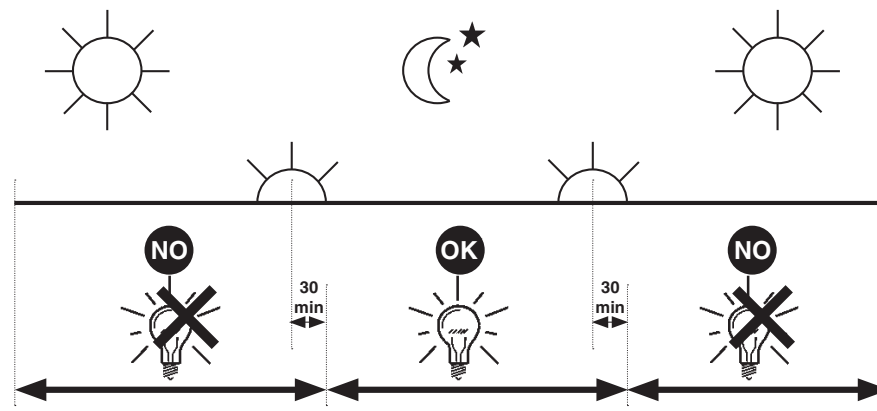

iGuzzini

2.509.386.00  
ISO9176/01

الفترة الزمنية اليومية للتشغيل المسموح بها

- I PERIODO GIORNALIERO DI ACCENSIONE AMMESSO
- GB ALLOWED DAILY OPERATION PERIOD
- E PERIODO DIARIO DE ENCENDIDO PERMITIDO

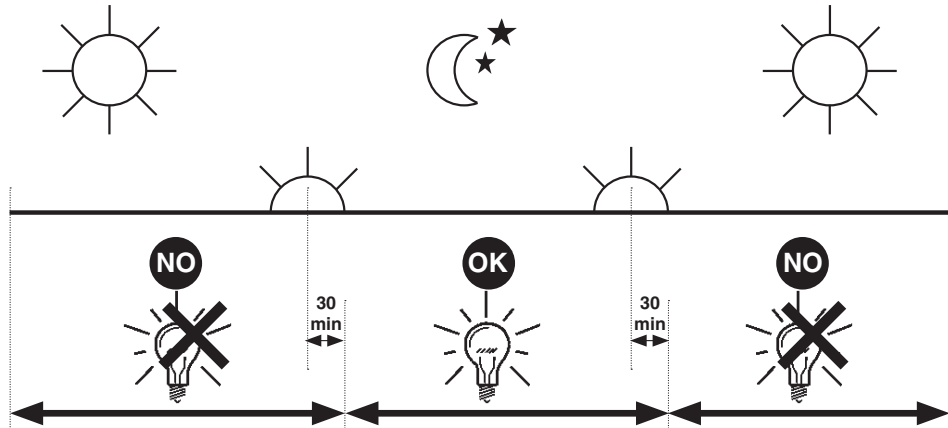

iGuzzini

2.509.386.00  
ISO9176/01

الفترة الزمنية اليومية للتشغيل المسموح بها

- I PERIODO GIORNALIERO DI ACCENSIONE AMMESSO
- GB ALLOWED DAILY OPERATION PERIOD
- E PERIODO DIARIO DE ENCENDIDO PERMITIDO

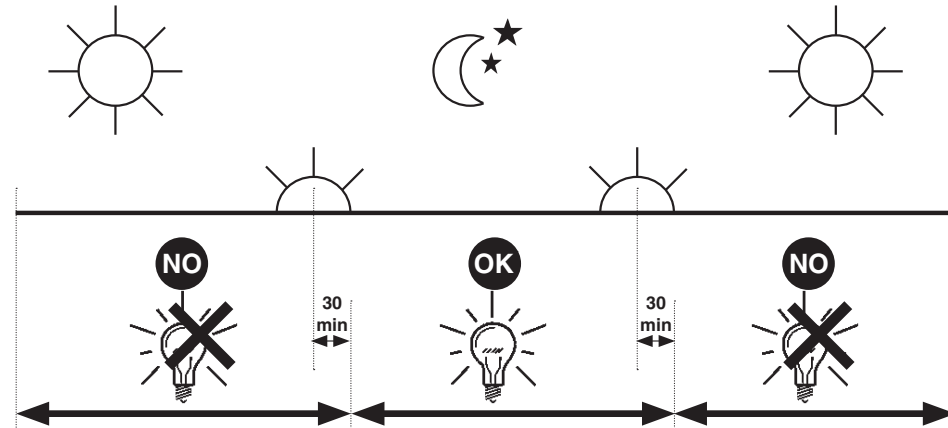

iGuzzini

2.509.386.00  
ISO9176/01

الفترة الزمنية اليومية للتشغيل المسموح بها

- I PERIODO GIORNALIERO DI ACCENSIONE AMMESSO
- GB ALLOWED DAILY OPERATION PERIOD
- E PERIODO DIARIO DE ENCENDIDO PERMITIDO

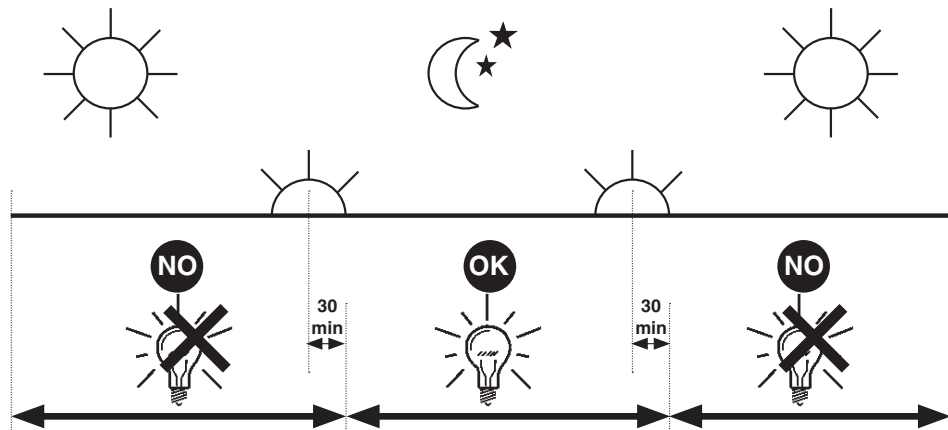

iGuzzini

2.509.386.00  
ISO9176/01

الفترة الزمنية اليومية للتشغيل المسموح بها

- I PERIODO GIORNALIERO DI ACCENSIONE AMMESSO
- GB ALLOWED DAILY OPERATION PERIOD
- E PERIODO DIARIO DE ENCENDIDO PERMITIDO

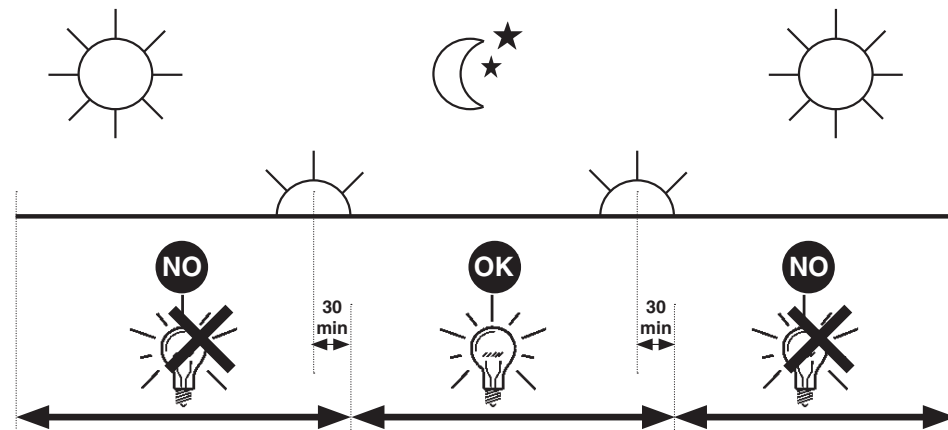



2.509.216.00  
IS05718/01

استبدال الضوء LED  
SOSTITUZIONE DEL LED  
REPLACING THE LED  
REEMPLAZO DEL LED

تنبیه: لاستبدال الضوء LED اتصل بشركة iGuzzini .

I N.B.: Per la sostituzione del LED contattare l'azienda iGuzzini.

GB N.B.: For information on LED replacement please contact iGuzzini.

E NOTA: Para sustituir el LED llame a la empresa iGuzzini.

فئة الخطر 1 . حسب مقاييس EN 62471: 2008 .

I Gruppo di rischio 1, secondo norma EN 62471: 2008

GB Risk Group: 1, in compliance with Standard EN 62471: 2008

E Grupo de riesgo 1, según norma EN 62471: 2008

iGuzzini

2.509.216.00  
IS05718/01

استبدال الضوء LED  
SOSTITUZIONE DEL LED  
REPLACING THE LED  
REEMPLAZO DEL LED

تنبیه: لاستبدال الضوء LED اتصل بشركة iGuzzini .

I N.B.: Per la sostituzione del LED contattare l'azienda iGuzzini.

GB N.B.: For information on LED replacement please contact iGuzzini.

E NOTA: Para sustituir el LED llame a la empresa iGuzzini.

فئة الخطر 1 . حسب مقاييس EN 62471: 2008 .

I Gruppo di rischio 1, secondo norma EN 62471: 2008

GB Risk Group: 1, in compliance with Standard EN 62471: 2008

E Grupo de riesgo 1, según norma EN 62471: 2008

iGuzzini

2.509.216.00  
IS05718/01

استبدال الضوء LED  
SOSTITUZIONE DEL LED  
REPLACING THE LED  
REEMPLAZO DEL LED

تنبیه: لاستبدال الضوء LED اتصل بشركة iGuzzini .

I N.B.: Per la sostituzione del LED contattare l'azienda iGuzzini.

GB N.B.: For information on LED replacement please contact iGuzzini.

E NOTA: Para sustituir el LED llame a la empresa iGuzzini.

فئة الخطر 1 . حسب مقاييس EN 62471: 2008 .

I Gruppo di rischio 1, secondo norma EN 62471: 2008

GB Risk Group: 1, in compliance with Standard EN 62471: 2008

E Grupo de riesgo 1, según norma EN 62471: 2008

iGuzzini

2.509.216.00  
IS05718/01

استبدال الضوء LED  
SOSTITUZIONE DEL LED  
REPLACING THE LED  
REEMPLAZO DEL LED

تنبیه: لاستبدال الضوء LED اتصل بشركة iGuzzini .

I N.B.: Per la sostituzione del LED contattare l'azienda iGuzzini.

GB N.B.: For information on LED replacement please contact iGuzzini.

E NOTA: Para sustituir el LED llame a la empresa iGuzzini.

فئة الخطر 1 . حسب مقاييس EN 62471: 2008 .

I Gruppo di rischio 1, secondo norma EN 62471: 2008

GB Risk Group: 1, in compliance with Standard EN 62471: 2008

E Grupo de riesgo 1, según norma EN 62471: 2008

iGuzzini

2.509.216.00  
IS05718/01

استبدال الضوء LED  
SOSTITUZIONE DEL LED  
REPLACING THE LED  
REEMPLAZO DEL LED

تنبیه: لاستبدال الضوء LED اتصل بشركة iGuzzini .

I N.B.: Per la sostituzione del LED contattare l'azienda iGuzzini.

GB N.B.: For information on LED replacement please contact iGuzzini.

E NOTA: Para sustituir el LED llame a la empresa iGuzzini.

فئة الخطر 1 . حسب مقاييس EN 62471: 2008 .

I Gruppo di rischio 1, secondo norma EN 62471: 2008

GB Risk Group: 1, in compliance with Standard EN 62471: 2008

E Grupo de riesgo 1, según norma EN 62471: 2008

iGuzzini

- I Istruzioni per le operazioni di servizio per l'apparecchio di illuminazione**  
**GB Instructions on luminaire service operations**  
**F Instructions pour les opérations de service du luminaire**  
**D Wartungsanleitung für die Leuchte**  
**NL Instructies voor de onderhoudsoperaties op de verlichtingsarmatuur**  
**E Instrucciones para las operaciones de servicio del aparato de alumbrado**  
**DK Anvisninger i serviceindgreb på belysningsarmatur**  
**N Anvisninger for betjening av lysapparatet**  
**S Instruktioner för användning av belysningsanordningen**  
**RUS Инструкция по эксплуатации осветительного прибора**  
**CN 照明装置检修操作说明**

**Sostituire la lampada parzialmente esausta**  
 Replace the partly exhausted lamp  
 Remplacer la lampe partiellement épuisée  
 Die teilweise erschöpfte Lampe austauschen  
 Vervang de gedeeltelijk lege lamp  
 Sustituir la lámpara parzialmente agotada  
 Udskift den delvist udtjente pære  
 Skifte ut den delvis utbrente lyspæren  
 Byt ut den delvis förbrukade lampan  
 Замена частично отработанной лампочки  
 更换部分老化的灯泡



**Spegnimento**  
 Switch it off  
 Extinction  
 Ausschaltung  
 Uitschakeling  
 Apagado  
 Slukning  
 Slukking  
 Släckning  
 Выключение  
 关灯

**Interrompere l'alimentazione dell'apparecchio**  
 Cut the power supply to the luminaire  
 Couper l'alimentation du luminaire  
 Stromversorgung der Leuchte unterbrechen  
 Onderbreek de voeding van het apparaat  
 Interrumpir la alimentación del aparato  
 Afbryd armaturets strømforsyning  
 Avbryt strømtilførselen til apparatet  
 Koppla från anordningens strömförsörjning  
 Отключить электропитание прибора  
 中断装置供电

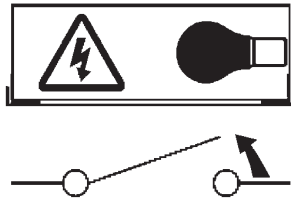

**Aprire l'apparecchio**  
 Open the fixture  
 Ouvrir le luminaire  
 Das Gerät öffnen  
 Open het apparaat  
 Abrir el aparato  
 Åbn armaturet  
 Åpne apparatet  
 Öppna anordningen  
 Раскрыть прибор  
 打开装置

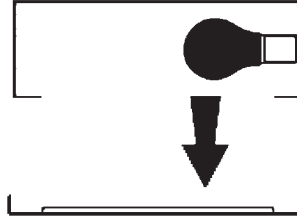

**Rimuovere la lampada esausta**  
 Remove the exhausted lamp  
 Retirer la lampe épuisée  
 Die alte Lampe entnehmen  
 Verwijder de lege lamp  
 Quitar la lámpara agotada  
 Tag den udtjente pære ud  
 Fjerne den utbrente lyspæren  
 Ta bort den förbrukade lampan  
 Вынуть старую лампочку  
 取出老化的灯泡

**Portarla in un centro di riciclaggio**  
 Carry it to a recycling centre  
 La porter dans une déchetterie pour son recyclage  
 Ordnungsgemäß entsorgen  
 Breng de lamp naar een recyclingcentrum  
 Llevarla a un centro de reciclaje  
 Aflever den på en genbrugsstation  
 Lever den til en miljøstasjon  
 Lämna in den till en återvinningsanläggning  
 Сдать ее в пункт приема утильсырья  
 将其送往回收中心

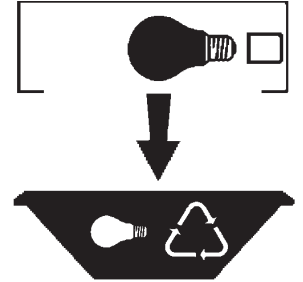

**Inserire la nuova lampada**  
 Introduce the new lamp  
 Installer la lampe neuve  
 Die neue Lampe einsetzen  
 Doe de nieuwe lamp op zijn plek  
 Montar la nueva lámpara  
 Sæt den nye pære i  
 Sette i den nye pæren  
 Sätt i den nya lampan  
 Вставить новую лампочку  
 装入新灯泡

**Inserire la nuova lampada nel portalampada**  
 Fit the new lamp into the socket  
 Installer la nouvelle lampe dans le support de lampe  
 Die neue Lampe in den Sockel einsetzen  
 Doe de nieuwe lamp in de lamphouder  
 Montar la nueva lámpara en el portalámpara  
 Sæt den nye pære i fatningen  
 Sette den nye pæren inn i lampeholderen  
 Sätt i den nya lampan i lamphållaren  
 Вставить новую лампочку в патрон  
 将新灯泡插入灯泡架中



**Riposizionare ottica**  
 Re-place the optic  
 Remettre l'optique à sa place  
 Die Optik wieder einsetzen  
 Doe de optiek weer op zijn plaats  
 Volver a montar la óptica  
 Sæt den optiske enhed på plads  
 Innstille linsen  
 Flytta om optiken  
 Отрегулировать линзы  
 重新定位光头

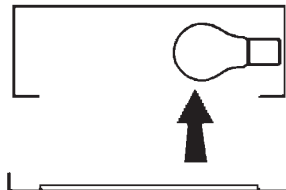

**Effettuare prova di funzionamento**  
 Perform operative test  
 Procéder à un essai de fonctionnement  
 Eine Funktionsprüfung durchführen  
 Controleer de correcte werking  
 Hacer una prueba de funcionamiento  
 Afprøv funktionen  
 Prøve om den fungerer  
 Utför funktionstest  
 Выполнить проверку исправности работы  
 执行功能测试



**I Istruzioni per la pulizia dell'apparecchio di illuminazione**  
**GB Instructions on luminaire cleaning operations**  
**F Instructions pour le nettoyage du luminaire**  
**D Anweisungen zur Reinigung der Leuchte**  
**NL Instructies voor de reiniging van de verlichtingsarmatuur**  
**E Instrucciones para limpiar el aparato de alumbrado**  
**DK Anvisninger i rengøring af belysningsarmaturet**  
**N Anvisninger for rengjøring av lysapparatet**  
**S Instruktioner för rengöring av belysningsanordningen**  
**RUS Инструкции по чистке осветительного прибора**  
**CN 照明装置清洁说明**

**Pulire l'apparecchio**  
**Clean the fixture**  
**Nettoyer le luminaire**  
**Das Gerät reinigen**  
**Reinig het apparaat**  
**Limpiar el aparato**  
**Rengør armaturet**  
**Rengjøre apparatet**  
**Rengör anordningen**  
**Чистка прибора**  
**清洁装置**



**Spegnimento**  
**Switch it off**  
**Extinction**  
**Ausschaltung**  
**Uitschakeling**  
**Apagado**  
**Slukning**  
**Slukking**  
**Släckning**  
**Выключение**  
**关灯**

**Interrompere l'alimentazione dell'apparecchio**  
**Cut the power supply to the luminaire**  
**Couper l'alimentation du luminaire**  
**Stromversorgung der Leuchte unterbrechen**  
**Onderbreek de voeding van het apparaat**  
**Interrumpir la alimentación del aparato**  
**Afbryd armaturets strømforstyrning**  
**Avbryt strømtilførselen til apparatet**  
**Koppla från anordningens strömförsörjning**  
**Отключить электропитание прибора**  
**中断装置供电**



**Spolverare l'ottica esterna**  
**Remove dust from the external optic**  
**Dépoussiérer l'optique extérieure**  
**Die externe Optik abstauben**  
**Stof de externe optiek af**  
**Quitar el polvo de la óptica exterior**  
**Tør støvet af den udvendige optiske enhed**  
**Fjerne støv fra den eksterne lysenheden**  
**Damma av den yttre optiken**  
**Вытереть пыль с внешней стороны линз**  
**为外侧光头掸尘**



**Lavare l'ottica esterna**  
**Wash the external optic**  
**Laver l'optique extérieure**  
**Die externe Optik waschen**  
**Was de externe optiek**  
**Lavar la óptica exterior**  
**Vask den udvendige optiske enhed**  
**Vaske den eksterne lysenheden**  
**Rengör den yttre optiken**  
**Вымыть линзы с внешней стороны**  
**清洁外光头**



**Rimuovere l'ottica**  
**Remove the optic**  
**Retirer l'optique**  
**Die Optik abnehmen**  
**Verwijder de optiek**  
**Quitar la óptica**  
**Tag den optiske enhed af**  
**Fjerne lysenheden**  
**Ta bort optiken**  
**Снять линзы**  
**取下光头**

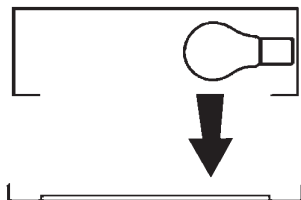

**Pulire la parte interna dell'apparecchio di illuminazione**  
**Clean the inside of the fixture**  
**Nettoyer l'intérieur du luminaire**  
**Die Innenseite der Leuchte reinigen**  
**Reinig de binnenzijde van de verlichtingsarmatuur**  
**Limpiar el interior del aparato de alumbrado**  
**Rengør belysningsarmaturets indvendige dele**  
**Rengjøre lysapparatet innvendig**  
**Rengör belysningsanordningen invändigt**  
**Протереть осветительный прибор изнутри**  
**清洁照明装置内部**

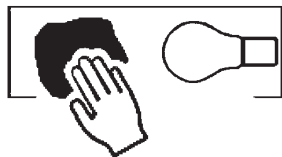

**Riposizionare ottica**  
**Re-place the optic**  
**Remettre l'optique à sa place**  
**Die Optik wieder einsetzen**  
**Doe de optiek weer op zijn plaats**  
**Volver a montar la óptica**  
**Sæt den optiske enhed på plads**  
**Innstille linsen**  
**Flytta om optiken**  
**Отрегулировать линзы**  
**重新定位光头**

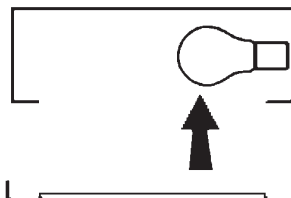

**Effettuare prova di funzionamento**  
**Perform operative test**  
**Procéder à un essai de fonctionnement**  
**Eine Funktionsprüfung durchführen**  
**Controleer de correcte werking**  
**Hacer una prueba de funcionamiento**  
**Afprøv funktionen**  
**Prøve om den fungerer**  
**Utför funktionstest**  
**Выполнить проверку исправности работы**  
**执行功能测试**

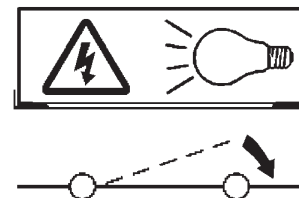

- I** Istruzioni per il fine vita e lo smaltimento dei componenti  
**GB** Instructions on end-of-life and component disposal  
**F** Instructions pour la gestion des composants en fin de vie et leur mise au rebut  
**D** Anweisungen zur Entsorgung der Leuchtenkomponenten  
**NL** Instructies voor het verwijderen van de armatuur en het recyclen van de onderdelen  
**E** Instrucciones para el final de vida y la eliminación los componentes  
**DK** Anvisninger i udtjent armatur og bortskaffelse af komponenter  
**N** Anvisninger for endt levetid og avfallsbehandling av delene  
**S** Instruktioner vid bortskaffning och kassering av komponenter  
**RUS** Инструкции по утилизации прибора и его комплектующих по окончании его срока службы  
**CN** 寿命期结束与零件废弃处置说明

<p>Spegnimento Switch it off Extinction Ausschaltung Uitschakeling Apagado Slukning Slukking Släckning Выключение 关灯</p> <p>Interrompere l'alimentazione dell'apparecchio Cut the power supply to the luminaire Couper l'alimentation du luminaire Stromversorgung der Leuchte unterbrechen Onderbreek de voeding van het apparaat Interrompirla alimentación del aparato Afbryd armaturets strømforsyning Avbryt strømtilførselen til apparatet Koppla från anordningens strömförsörjning Отключить электропитание прибора 中断装置供电</p> 	<p>Rimuovere la/e lampada/e per la dismissione Remove the lamp(s) for decommissioning Retirer la(les) lampe(s) pour sa(leur) mise au rebut Die Lampe/n ordnungsgemäß entsorgen Verwijder de lamp(en) voor het recyclen Quitar la(s) lámpara(s) para el desecho Tag pæren/pærerne ud til bortskaffelse Fjerne lampen/-e som skal kastes Ta bort lampan/-orna för bortskaffningen Вынуть лампочку/и для утилизации прибора 取出需要丢弃的灯泡</p> 	<p>Rimuovere la batteria per la dismissione Remove the battery for decommissioning Retirer la batterie pour sa mise au rebut Die Batterie ordnungsgemäß entsorgen Verwijder de batterij voor het recyclen Quitar la batería para el desecho Tag batteriet ud til bortskaffelse Fjerne batteriet som skal kastes Ta bort batteriet för bortskaffningen Вынуть батарейку для утилизации прибора 取出需要丢弃的电池</p> 	<p>Rimuovere l'apparecchio per la dismissione Remove the fixture for decommissioning Enlever le luminaire pour sa mise au rebut Das Gerät ordnungsgemäß entsorgen Verwijder het apparaat voor het recyclen Quitar el aparato para el desecho Tag armaturet ud til bortskaffelse Fjerne apparatet som skal kastes Ta bort anordningen för bortskaffningen Снять прибор для утилизации 取出需要丢弃的装置</p> 
---	--	--	--

<p>Inviare i materiali ad un centro di raccolta RAEE Send the materials to a WEEE collection centre Envoyer les matériaux dans une déchetterie DEEE Die Materialien in einem WEEE-Zentrum entsorgen Zend de materialen naar een recyclingscentrum voor de AEEA Enviar los materiales a un centro de recogida RAEE Afløver materialerne på et indsamlingscenter for elektronisk udstyr Sende materialene til en miljøstasjon for resirkulering av EE-avfall Skicka materialet till en RAEE uppsamlingscentral Сдать материалы в пункт приема утильсырья 将材料送往电气和电子垃圾回收中心</p> 			
--	--	--	--