

# STRANGE

25-07-2016

## 2.0 LED

**LED** 2x7/10W | 350-500mA | 18Vf | COB 3-step | excl. power supply

CE <img alt="IP20 symbol" data-bbox="95 214 115 230"/> IP20 <img alt="960°C symbol" data-bbox="125 214 145 230"/> 960°C <img alt="0.3m symbol" data-bbox="155 214 175 230"/> 0,3m <img alt="TE symbol" data-bbox="185 214 205 230"/> TE <img alt="35°/35° symbol" data-bbox="215 214 235 230"/> 35°/35° <img alt="355° symbol" data-bbox="245 214 265 230"/> 355°

white texture  
black texture

131261W\_  
131261B\_

### LIGHT COLOUR

2700K | >90CRI | 2x420-590lm | 18Vf  
3000K | >90CRI | 2x470-640lm | 18Vf  
1800-2850K | >90CRI | 2x320-440lm | 18Vf

3  
5  
9

### ALWAYS USE

plaster kit  
for power supplies see our catalogue

90017117

## 2.0 PAR16

<img alt="Speaker icon" data-bbox="55 403 75 420"/> 2xPAR16 max. 35W | GU10 | 220-240VAC | 50-60Hz

CE <img alt="IP20 symbol" data-bbox="85 419 105 437"/> IP20 <img alt="960°C symbol" data-bbox="115 419 135 437"/> 960°C <img alt="0.3m symbol" data-bbox="145 419 165 437"/> 0,3m <img alt="35°/35° symbol" data-bbox="175 419 195 437"/> 35°/35° <img alt="355° symbol" data-bbox="205 419 225 437"/> 355° <img alt="DO NOT COVER symbol" data-bbox="235 419 255 437"/> DO NOT COVER

white texture  
black texture

131220W0  
131220B0

### ALWAYS USE

plaster kit  
for PAR16 lamps see our catalogue

90017117

plaster kit (has to be ordered separately)

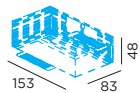

2.0 LED

2.0 PAR16

①

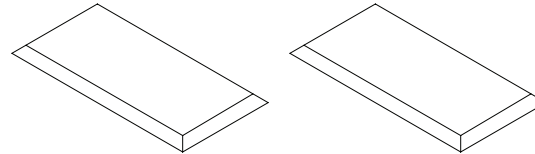

②

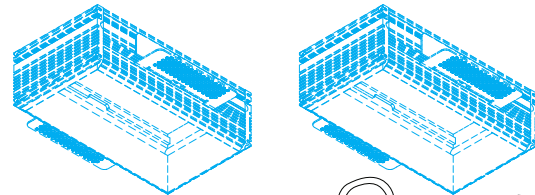

④

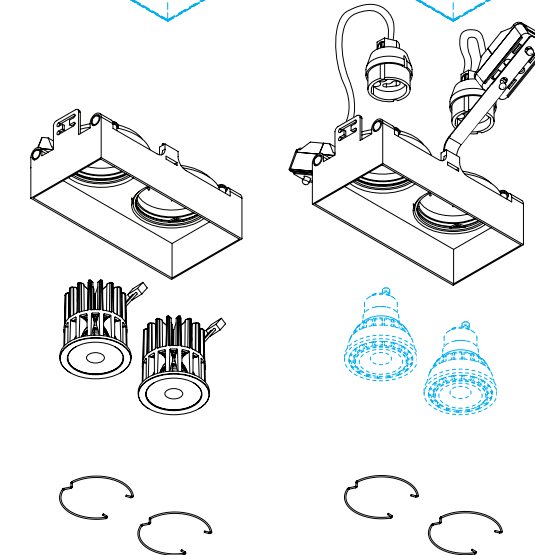

## DIMENSIONS

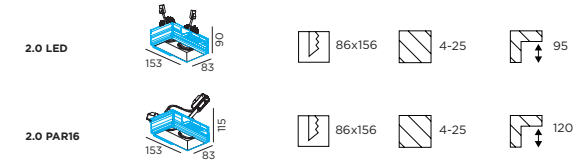

## MOUNTING INSTRUCTION

- ① Make a hole in the ceiling according to the prescribed dimensions (always use a plaster kit)
- ② Insert the upper part of the fixture into the ceiling and plaster the borders seamlessly

## POWER CONNECTION

- ③ SERIAL CONNECTION - for LED  
Always use **POWER SUPPLY** according to the specifications of the LED-module

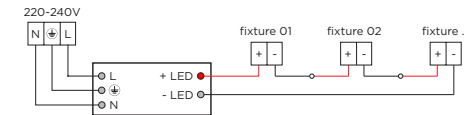

### PARALLEL CONNECTION - for PAR16

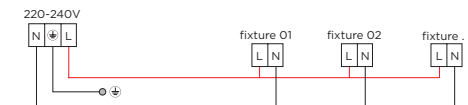

- ④ Insert the fixture in the upper part. Place the LED-module or PAR16 lamp and fix with spring.
- ⑤ SAFETY DISTANCE FOR HALOGEN LAMPS .....

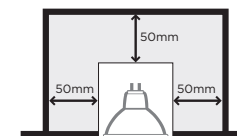

WEVER & DUCRÉ  
LIGHTING

www.weverducre.com

INSTALLATION  
INSTRUCTIONS

# STRANGE 2.0 & SNEAK 2.0 PLASTER KIT

26-Nov.-2016

plaster kit

90017117-02

plaster kit (has to be ordered separately)

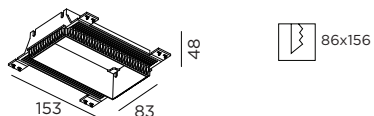

NOTE: There are 4 foldable gaskets on the plaster kit.

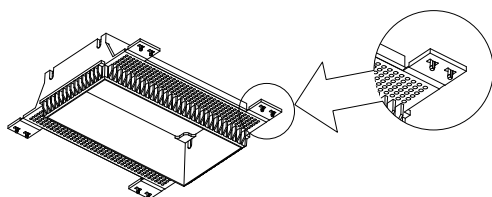

When the thickness of wood board is 12mm, the gasket will be **opened**;

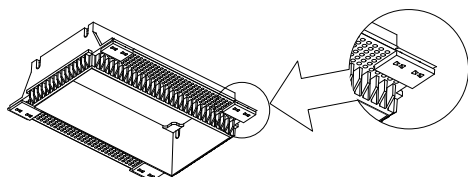

when the thickness of wood board is 9mm, the gasket should be **folded**.

2.0 LED

2.0 PAR16

①

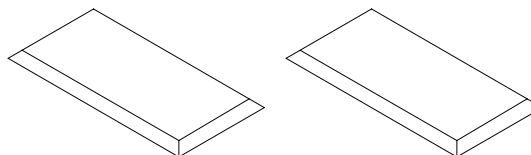

②

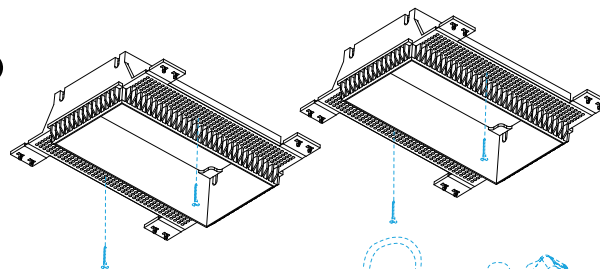

④

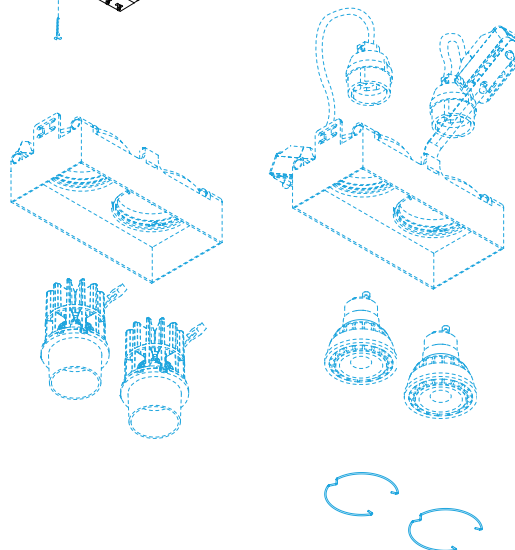

## DIMENSIONS

1.0 LED

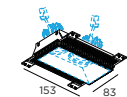

1.0 PAR16

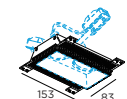

## MOUNTING INSTRUCTION

- ① Make a hole in the ceiling according to the prescribed dimensions (always use a plaster kit)
- ② Click in the plaster kit into the ceiling and screw it tightly on the ceiling, then plaster the borders seamlessly.
- ③ POWER CONNECTION
- ④ Insert the fixture in plaster kit.  
for LED: Place the LED-module in the fixture.  
for PAR16: Place the PAR16 lamp in the fixture and fix with spring.



WEVER & DUCRÉ  
LIGHTING

[www.weverducre.com](http://www.weverducre.com)

Wever & Ducre bvba Kwadestraat 153 bus 2.1 8800 Roeselare

INSTALLATION  
INSTRUCTIONS