

## ESSENS 26W downlight

flat, white, 2x TC-DE Energy Saver

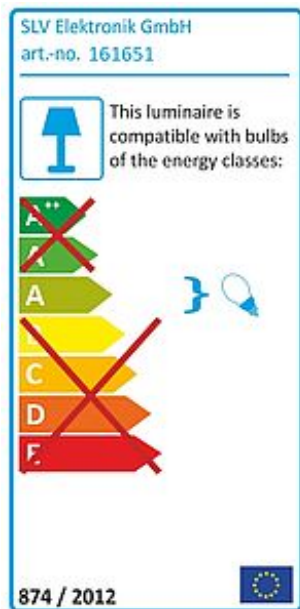

Article number	161651
Catalogue	BIG WHITE 2015, Page 419
Type of lamp	Conventional lamp
Lamp	TC-DE compact fluorescent bulb 26W
Lampholder / Socket	G24q-3
Number of light sources	2
Lamp included	No
Installation diameter	18.5 cm
Installation depth	19 cm
Length	36 cm
Height	11.5 cm
Diameter	20 cm
Net weight	1.039 kg
Gross weight	2.047 kg
Voltage	230 Volt
Max. wattage	52 Watt
Protection class	II
Material	aluminium / plastic
Colour	white
Way of mounting	recessed ceiling mounting
Remark 1	Only suitable for ceilings with a maximum thickness of 30 mm
Remark 2	The luminaire is suitable for through wiring
Remark 3	Electronic ballast incorporated
Remark 4	Energy labels in your language are available in the Service Area sub point Download
Energy class ballast	A2
Suitable for lamps from EEC	A
Suitable for lamps up to EEC	A
Light distribution type 1	direct

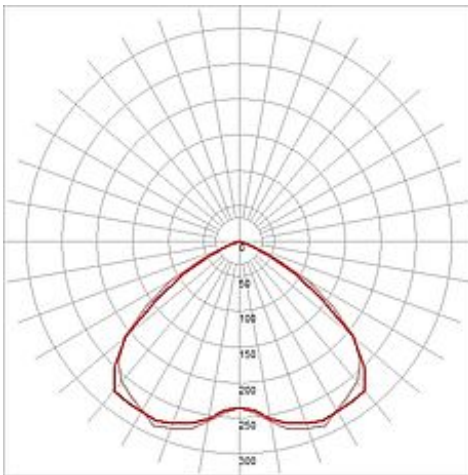
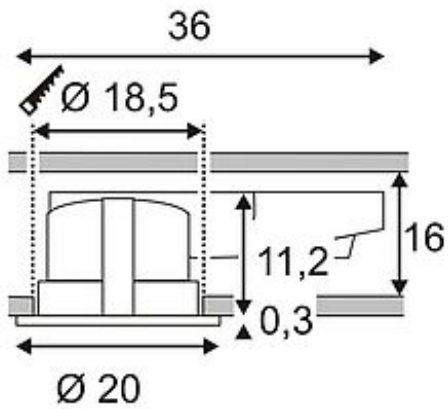

Light distribution axisymmetric  
type 3

The grid downlight ESSENS 26W is available in white colour version. Designed for TC-DE energy-saving lamps with 26W output, the fitting is supplied ready for direct connection to 230V mains supply via the incorporated low-loss ballast. This luminaire is compatible with bulbs of the energy classes: A - A