

SFL PAR56 T 70 LONG HV G12 spot

alu, max. 70W

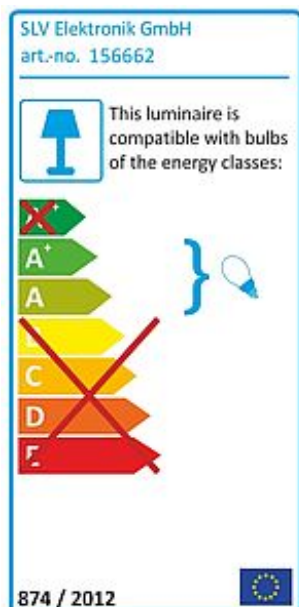

Article number	156662
Type of lamp	Conventional lamp
Lamp	HQI-T / CDM-T 70W
Lampholder / Socket	G12
Number of light sources	1
Lamp included	No
Tilt range	180 Degree
Rotation range	350 Degree
Length	40.5 cm
Width	22.8 cm
Height	22.8 cm
Net weight	3.365 kg
Gross weight	5.642 kg
Voltage	230 Volt
Max. wattage	70 Watt
Protection class	I
Material	aluminium
Colour	aluminium
Way of mounting	surface wall mounting / surface ceiling mounting
Remark 1	100 cm connection lead with plug included
Remark 2	Not dimmable
Remark 3	Energy labels in your language are available in the Service Area sub point Download
Energy class ballast	A3
Suitable for lamps from EEC	A
Suitable for lamps up to EEC	A+
Type of plug	2 pin schuko plug
Light distribution type 1	direct
Light distribution type 3	rotationally symmetric

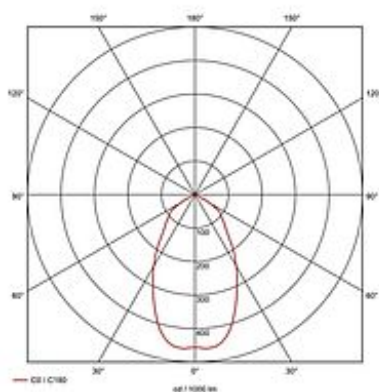
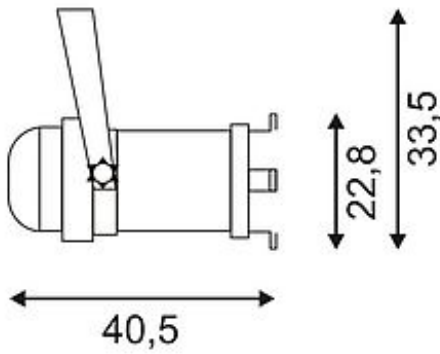

Adjustable spotlight SFL PAR20. The G12 lampholder is placed within the aluminum body of the fitting. Thus, the spotlight is suitable for the use of metal halide lamps. A suitable ballast to operate this type of lamps is already built-in. The electrical connection is made directly to 230V mains supply via connection lead with incorporated mains plug. For simplified mounting to walls or ceilings the spot is equipped with a mounting bracket. We alternatively offer versions for higher wattages or Rx7s lampholder. This luminaire is compatible with bulbs of the energy classes: A - A+