

EURO SPOT INTEGRATED LED

white, 13W, 4000K, 36°, incl. 3-circuit adaptor

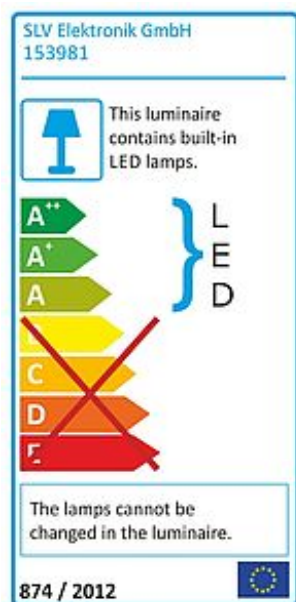

Article number	153981
Catalogue	BIG WHITE 2015, Page 317
Type of lamp	LED lamp
Lamp	Philips Fortimo LED Integrated Spot-Module
Number of light sources	1
Lamp included	Yes
Tilt range	100 Degree
Rotation range	350 Degree
Length	16 cm
Height	17.5 cm
Diameter	8 cm
Net weight	0.83 kg
Gross weight	0.949 kg
Voltage	230 Volt
Max. wattage	12.6 Watt
Protection class	I
Beam angle	36 Degree
Material	aluminium
Colour	white
Way of mounting	track system mounting
Remark 1	Equipped with the LED integrated spot module of Philips
Remark 2	The mounted adapter is suitable for all conventional 3 circuit tracks
Remark 3	Energy labels in your language are available in the Service Area sub point Download
Average lifespan	50000 Hours
Colour temperature	4000 Kelvin
Colour rendering index	80
Luminous flux	640 lm
Suitable for lamps from EEC	A
Suitable for lamps up to EEC	A++

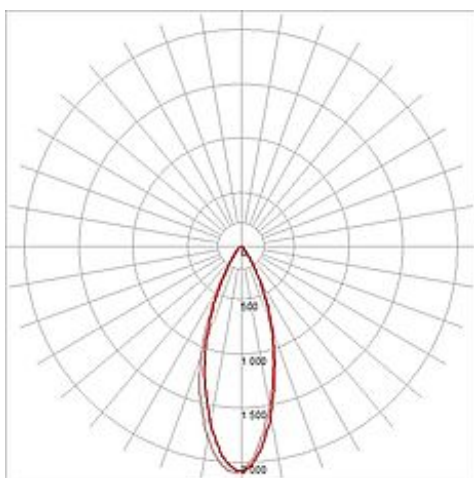
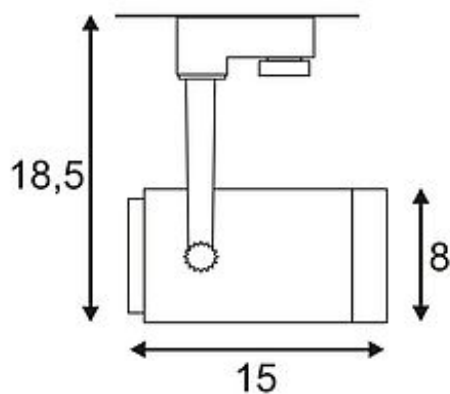

Light distribution
type 1

direct

Light distribution
type 3

rotationally symmetric

Adjustable high-voltage LED spotlight EUROSPT INTEGRATED LED with suitable adaptor for the 3-circuit high-voltage track system. Within the cylindrical lamp head, the powerful Philips Fortimo Integrated Spot module is fitted. EUROSPT INTEGRATED LED is available in warm or pure white light colours. In addition, we offer versions with three different beam angles. This luminaire contains built-in LED lamps. EEK: A - A++. The lamps cannot be changed in the luminaire.