

EURO SPOT EVG

matt black, HQI-T, 70W, 60°, incl. 3-circuit adaptor

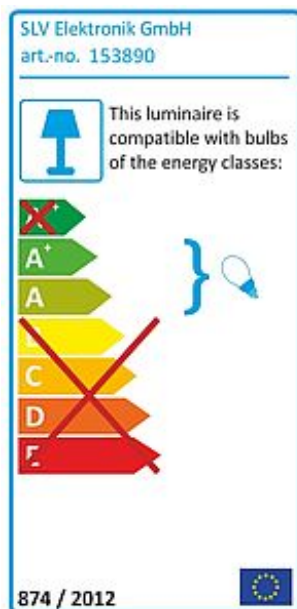
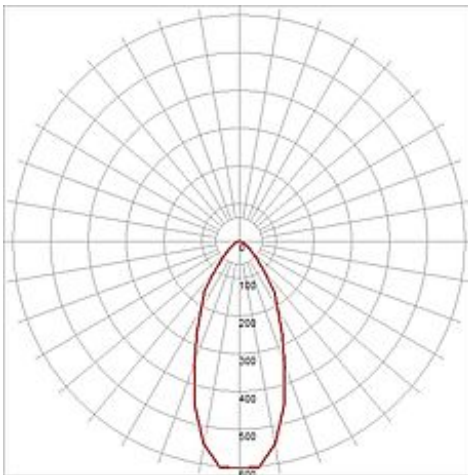

Article number	153890
Catalogue	BIG WHITE 2015, Page 319
Type of lamp	Conventional lamp
Lamp	CDM-T 70W G12
Lampholder / Socket	G12
Number of light sources	1
Lamp included	No
Tilt range	100 Degree
Rotation range	350 Degree
Length	30.5 cm
Height	30 cm
Diameter	12.5 cm
Net weight	2.009 kg
Gross weight	2.222 kg
Voltage	230 Volt
Max. wattage	70 Watt
Protection class	I
Beam angle	60 Degree
Material	aluminium
Colour	black
Way of mounting	track system mounting
Remark 1	Electronic ballast incorporated
Remark 2	The mounted adaptor is suitable for all conventional 3 circuit tracks
Remark 3	Energy labels in your language are available in the Service Area sub point Download
Energy class ballast	A2
Suitable for lamps from EEC	A
Suitable for lamps up to EEC	A+
Light distribution type 1	direct

Light distribution type 3 rotationally symmetric

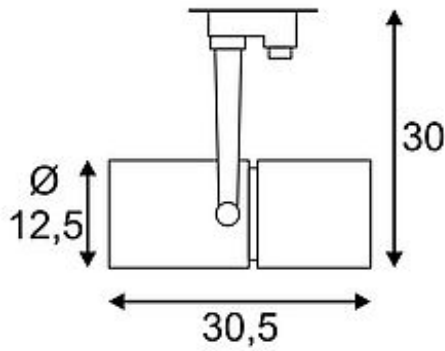

Adjustable and professional high-voltage spotlight EURO SPOT EVG with suitable adaptor for the 3-circuit high-voltage track system. Designed for G12 discharge lamps, the incorporated ballast makes EURO SPOT EVG suitable for either 35W, 50W or 70W lamps depending on the respective version. Furthermore, we offer different colour versions with different beam angles. The modern electronic ballast is incorporated in the rear part of the lamp head. This luminaire is compatible with bulbs of the energy classes: A - A+