

EURO SPOT G12

60°, white, 70W, incl. 3-circuit adaptor

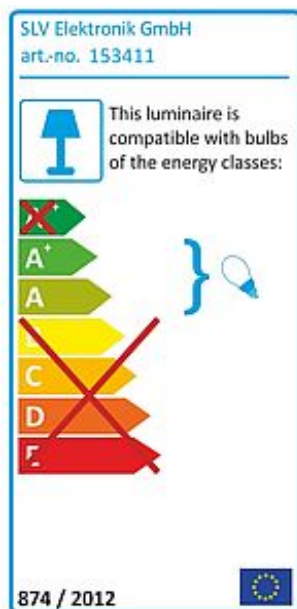
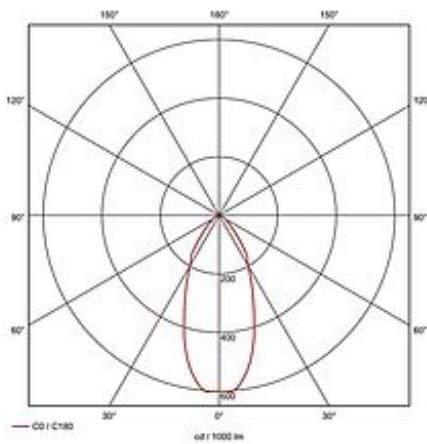

Article number	153411
Catalogue	BIG WHITE 2015, Page 319
Type of lamp	Conventional lamp
Lamp	HQI-T / CDM-T 70W
Lampholder / Socket	G12
Number of light sources	1
Lamp included	No
Tilt range	100 Degree
Rotation range	350 Degree
Length	32 cm
Width	16.5 cm
Diameter	12.5 cm
Net weight	2.993 kg
Gross weight	3.217 kg
Voltage	230 Volt
Max. wattage	70 Watt
Protection class	I
Beam angle	60 Degree
Material	aluminium
Colour	white
Way of mounting	track system mounting
Remark 1	Conventional ballast incorporated
Remark 2	The mounted adaptor is suitable for all conventional 3 circuit tracks
Remark 3	Energy labels in your language are available in the Service Area sub point Download
Energy class ballast	A3
Suitable for lamps from EEC	A
Suitable for lamps up to EEC	A+
Light distribution type 1	direct

Light distribution rotationally symmetric
type 3

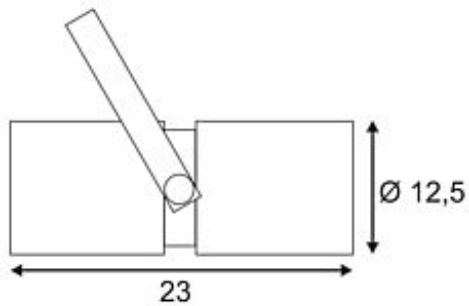

Adjustable and professional high-voltage spotlight EURO SPOT G12 with suitable adaptor for the 3-circuit high-voltage track system. Designed for G12 discharge lamps, the incorporated ballast makes it suitable for 70W lamps. Furthermore, it is available in several colors and beam angles. The ballast is installed in the rear part of the cylindrical lamp head. This luminaire is compatible with bulbs of the energy classes: A - A+