

COB LED-MODULE

for AIXLIGHT PRO installation frame, 3000K, white, 30°

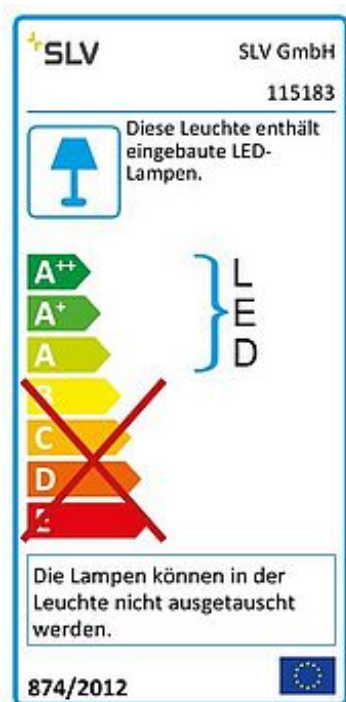

Article number	115183
Feed-in capability	No
Lamp included	No
Height	13 cm
Diameter	13.5 cm
Net weight	0.523 kg
Gross weight	0.652 kg
Voltage	700mA/1000mA/1050mA
Protection class	III
Beam angle	30 Degree
Average lifespan	30000 Hours
Colour temperature	3000 Kelvin
Colour rendering index	80
Luminous flux	3500 lm
Energy efficiency class	A++
Way of mounting	Recessed mounted / Ceiling recessed with accessories
Colour	matt white
Light distribution type 1	direct
Light distribution type 2	rotational symmetric
Material	Aluminium/glass

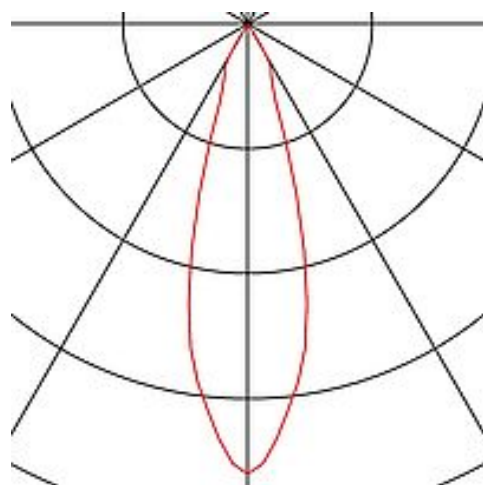
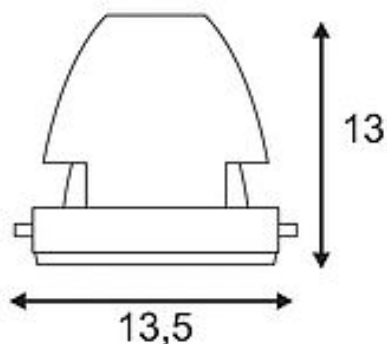

Articles of this series

115181	COB LED-MODULE, for AIXLIGHT PRO installation frame, 3000K, white, 12°
115187	COB LED-MODULE, for AIXLIGHT PRO installation frame, 3000K, white, 70°
115191	COB LED MODULE, for AIXLIGHT PRO installation frame, 3000K, silver-grey, 12°
115193	COB LED MODULE, for AIXLIGHT PRO installation frame, 3000K, silver-grey, 30°
115197	COB LED MODULE, for AIXLIGHT PRO installation frame, 3000K, silver-grey, 70°
115024	ES111 BRITESPOT MODULE, for AIXLIGHT PRO installation frame, HIPAR111, silver-grey/black, max. 70W
115094	ENERGYSAVER MODULE, for AIXLIGHT PRO, TC-TSE, silver-grey / black, max. 21W
115041	G12 MODULE, for AIXLIGHT PRO installation frame, HIT-CE, white/black, 24°, max. 70W
115051	G12 MODULE, for AIXLIGHT PRO installation frame, HIT-CE, white/black, 58°, max. 70W
115001	QR111 MODULE, for AIXLIGHT PRO installation frame, QR111, matt white, max. 75W
115004	QR111 MODULE, for AIXLIGHT PRO installation frame, QR111, silver-grey/black, max. 75W
115011	QPAR111 MODULE, for AIXLIGHT PRO installation frame, QPAR111, white, max. 75W
115014	QPAR111 MODULE, for AIXLIGHT PRO installation frame, QPAR111, silver-grey/black, max. 75W
115201	COB LED MODULE, for AIXLIGHT PRO installation frame, matt white, 12°, CRI90+
115203	COB LED MODULE, for AIXLIGHT PRO installation frame, matt white, 30°, CRI90+
115207	COB LED MODULE, for AIXLIGHT PRO installation frame, matt white, 70°, CRI90+
115211	COB LED MODULE, for AIXLIGHT PRO installation frame, matt white, 12°, CRI65+
115213	COB LED MODULE, for AIXLIGHT PRO installation frame, matt white, 30°, CRI65+

115217	COB LED MODULE, for AIXLIGHT PRO installation frame, matt white, 70°, CRI65+
115221	COB LED MODULE, for AIXLIGHT PRO installation frame, matt white, 12°, CRI90+
115223	COB LED MODULE, for AIXLIGHT PRO installation frame, matt white, 30°, CRI90+
115227	COB LED MODULE, for AIXLIGHT PRO installation frame, matt white, 70°, CRI90+
115231	COB LED MODULE, for AIXLIGHT PRO installation frame, silver-grey, 12°, CRI90+
115233	COB LED MODULE, for AIXLIGHT PRO installation frame, silver-grey, 30°, CRI90+
115237	COB LED MODULE, for AIXLIGHT PRO installation frame, silver-grey, 70°, CRI90+
115241	COB LED MODULE, for AIXLIGHT PRO installation frame, silver-grey, 12°, CRI65+
115243	COB LED MODULE, for AIXLIGHT PRO installation frame, silver-grey, 30°, CRI65+
115247	COB LED MODULE, for AIXLIGHT PRO installation frame, silver-grey, 70°, CRI65+
115251	COB LED MODULE, for AIXLIGHT PRO installation frame, silver-grey, 12°, CRI90+
115253	COB LED MODULE, for AIXLIGHT PRO installation frame, silver-grey, 30°, CRI90+
115257	COB LED MODULE, for AIXLIGHT PRO installation frame, silver-grey, 70°, CRI90+
115044	G12 MODULE, for AIXLIGHT PRO installation frame, HIT-CE, silver-grey / black, 24°, max. 70W
115054	G12 MODULE, for AIXLIGHT PRO installation frame, HIT, silver-grey / black, 58°, max. 70W
115064	G12 MODULE, for AIXLIGHT PRO installation frame, HIT, silver-grey / black, 8°, max. 70W
115071	QR111 MODULE MOVE for AIXLIGHT PRO installation frame, QR-LP111, matt white, max. 75W
115074	QR111 MODULE MOVE for AIXLIGHT PRO installation frame, QR-LP111, silver-grey / black, max. 75W
115454	LED DISK MODULE, for AIXLIGHT PRO installation frame, 2700K, silver-grey/black, 50°

115464 LED DISK MODULE, for AIXLIGHT PRO installation frame,
4000K, silver-grey/black, 50°

115451 LED DISK MODULE, for AIXLIGHT PRO installation frame,
2700K, matt white, 50°

115461 LED DISK MODULE, for AIXLIGHT PRO installation frame,
4000K, matt white, 50°

The COB LED Module was designed specifically for use in AIXLIGHT PRO installation frame. The warm white COB LED module is available in matt white or silver grey, and in various beam angles. Operation requires an LED driver with a constant current of 700mA, 1000mA, or 1050mA. Not suitable for flat installation frames.

Notes
