

MICROSLOT PARETE DOWN

Art.S.3934

Per 1 lampada dicroica 35W 12V GU5,3

Art.S.3903 - S.3903W - S.3904 -S.3937

Con 1 accent led 3x1,2W 230-240V

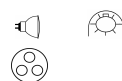

MICROSLOT PARETE UP AND DOWN

Art.S.3944



Per 2 lampade dicroiche 35W 12V GU5,3

Art.S.3913 - S.3913W

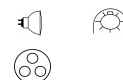
Con 2 accent led 3x1,2W 230-240V

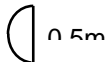

 Utilizzare solo lampade che non necessitano di schermi di protezione

 $\geq 5m$  Mantenere almeno 0,5m di distanza tra l'apparecchio e la superficie illuminata

ISTRUZIONI DI MONTAGGIO

Rimuovere la flangia di fissaggio a parete (A) svitando le viti (B)

Aprire l'apparecchio rimuovendo gli anelli e i vetri (C) (NO PER VERSIONI LED)

Installare la flangia di fissaggio a parete mediante N°2 tasselli tipo fisher (non forniti)

Collegare il cavo di alimentazione (D.min 8mm - D.max 12mm) al morsetto tripolare nella scatola di cablaggio

Per tutte le altre versioni lo schema in **figura 1**

Richiudere la scatola di cablaggio riavvitando le viti (B)

Inserire le lampade indicate nei dati di targa, fissarle con le apposite molle (NO PER VERSIONI LED) e regolarne l'inclinazione come desiderato agendo sul sistema basculante.

Richiudere l'apparecchio

Reinstallare gli anelli e i vetri (C)

FIGURA 1

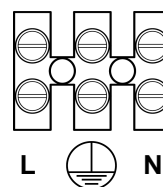

L = LINEA

 = TERRA

N = NEUTRO

AVVERTENZE:

Non superare la potenza indicata nei dati di targa

La presa di terra è obbligatoria (CLASSE I)

Togliere tensione prima di effettuare manutenzioni

Usare cavi di alimentazione di tipo <HAR>

In caso di rottura sostituire il diffusore prima di riutilizzare l'apparecchio

NOTE: **MICROSLOT PARETE** è un apparecchio sofisticato e deve essere installato da un elettricista qualificato

SIMES

luce per l'architettura

ISTRMICRSLPA REV.5 08/13

MICROSLOT WALL

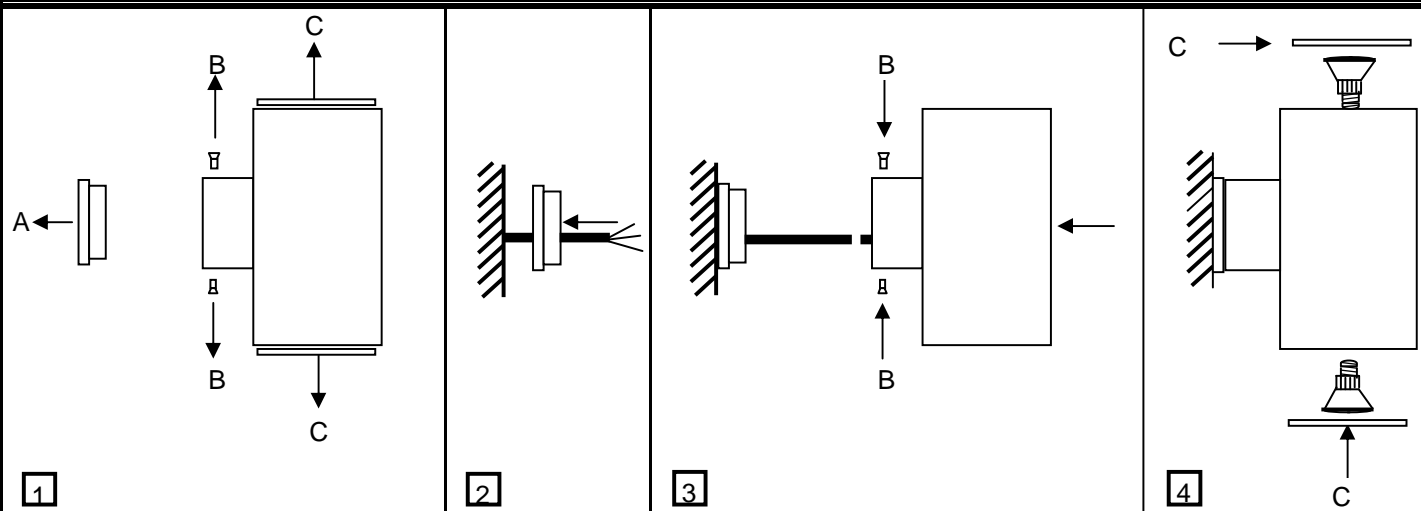

MICROSLOT WALL DOWN

Art.S.3934

For 1 halogen lamp 35W 12V GU5,3

Art.S.3903 - S.3903W - S.3904 -S.3937

With 1 accent led 3x1,2W 230-240V



MICROSLOT WALL UP AND DOWN

Art.S.3944

For 2 halogen lamp 35W 12V GU5,3

Art.S.3913 - S.3913W

With 2 accent led 3x1,2W 230-240V



Use only lamps where the protection screen is not necessary

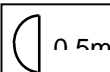

Minimum distance between fitting and lit surface = 0,5 m.

INSTALLATION INSTRUCTION

Remove the fixation plate (A) unscrewing the screws (B)
pen the fitting and remove the rings
and glasses (C) (NO FOR LED VERSION)

Install the fixation plate to the wall with screws not supplied N°2
(see pic.2)

Coonnect the power (D.min 8mm - D.max 12mm)
to the terminal block in the gear box

For all versions follow the scheme on **picture 1**

Insert the fitting on the fixation plate and lock the screws (B)

Insert the correct lamps and fix them with the spring (NOT FOR LED VERSION);

set the inclination on your request rotating the pivoting system

Close the fitting

Re-installing glasses and rings (C)

PICTURE 1

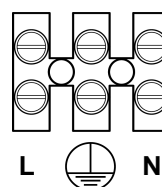

L = LINE

= EARTH

N = NEUTRAL

RECOMMENDATIONS:

Do not exceed the maximum wattage-see internal label

The fitting must be earthed (CLASS I)

Disconnect the power before maintenance

Use <HAR> cable

In case of glass damage, replace it before using the fitting

NOTE: MICROSLOT WALL is a sophisticated luminaire and should be installed
by a qualified electrician

SIMES
luce per l'architettura