

## TECHNICAL DATA SHEET ART. S.8820.19 - MINIZIP SQUARE

Available until 31/12/2017 but subject to stock levels

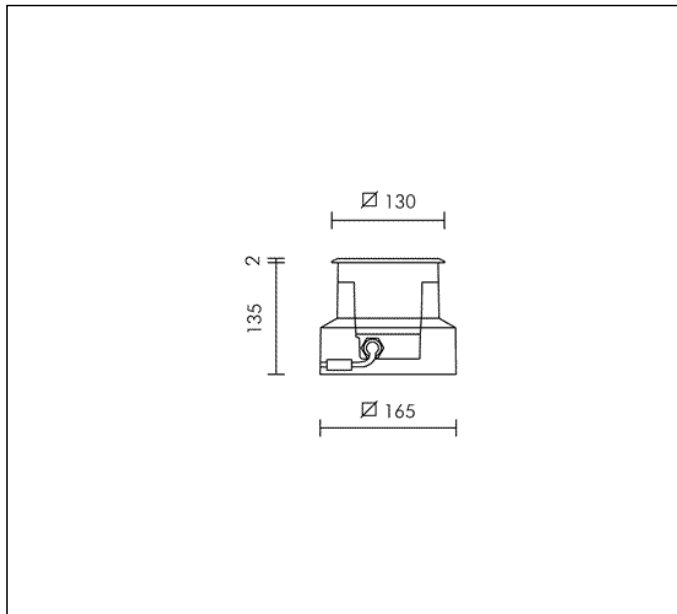

3 MODULES LED 6000K 230V 534lm 4.5W CRI 75  
 Rated luminaire luminous flux: 410lm  
 Rated input power: 6W  
 Luminaire efficacy: 68lm/W  
 Electronic ballast 220÷240V 50/60Hz

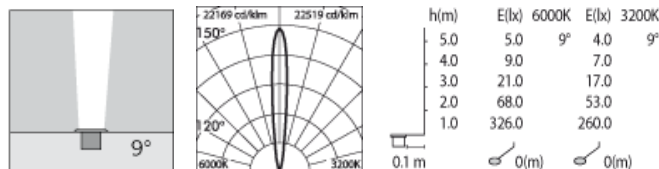

### PRODUCT TYPE

Inground walk over fitting. Recessing depth 135 mm. IP rating IP 67

### MATERIAL CHARACTERISTICS

"Copper Free" Aluminium die cast housing in EN AB-44100 with high resistance against corrosion. Stone wash surface treatment prior to painting process. 2 mm thick front trim in Stainless Steel - Grade AISI 316L with 2,5-3% molybdenum content. A4 grade Stainless Steel screws with 2,5-3% molybdenum content which increases the resistance against corrosion. Pre treated Silicone Gaskets. Painting Process : 3 Step Process

1) Surface treatment with BONDERITE. A heavy metal free chemical surface treatment containing ceramic nano particles giving a cohesive, inorganic and highly dense protective coating. 2) PRE POLYMERIZATION a process of introducing an epoxy primer with excellent characteristics to the paint which also offers very high resistance to oxidation due to its Zinc content. 3) POLYMERIZATION a process with the application of polyester powder with high resistance against UV rays and harsh weather conditions. Resistance test protection for Marine applications for 1200h. Mechanical resistance IK 09 Maximum load capacity 1000 Kg

### LIGHTING PERFORMANCE

Toughened semiacid-etched glass 8mm thick. Lamp adjustable ±15° position. LOR --

### LOW SURFACE TEMPERATURE

Surface temperature of glass 37°C (Ta 25°C)

### RECESSING BOX

Polypropylene recessing box with cable entry on all 4 sides also allows: 1) Easy wiring; 2) Cable management for fast connector; 3) Easy access to the fitting for maintenance purposes.

### WIRING

Supply 0.5m cable section type H07RN-F secured by cable gland PG 13.5 (Ø 6÷12 mm) and sealed with B component epoxy resin, wired internally protected by silicon sheaths. Front re-lamping without removing the complete fitting. Isolation: CLASS I. Available colours: Stainless steel (cod.19). Weight: 1.5 Kg Glow Wire test: 850°C

### L.E.D circuit included.

This luminaire contains built-in LED modules with energy class: A, A+, A++. In case of damage or malfunction please contact the manufacturer to receive additional instructions on how to replace and relative spare parts to order. The LED modules cannot be handled in the luminaire by the end user (Regulation UE 874/2012).

LED circuit boards are engineered accordingly to actual Lumen Maintenance regulation (LM80) and Technical Memorandum (TM21) where uniformity and quality of light is 50.000 hours referred to L70 B20 Ta 25°C.

Lifecycle refers to LED circuit boards only, all others components of the luminaire are excluded.

**TECHNICAL DATA SHEET ART. S.8820.19 - MINIZIP SQUARE  
INCLUDED ACCESSOIRES**



**FAST CONNECTOR INCLUDED**