

TECHNICAL DATA SHEET ART. S.6879 - MEGAVEDO ROUND

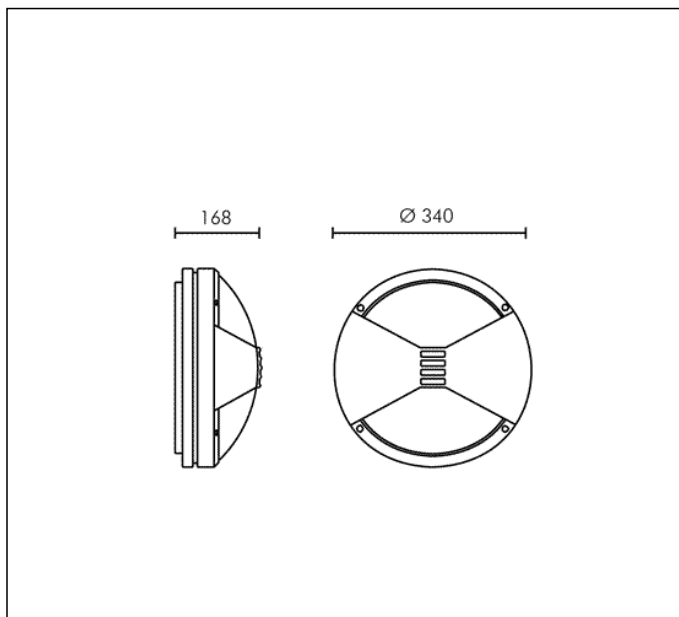

TC-F 36W 2G10 2800lm
 Rated luminaire luminous flux: 896lm
 Rated input power: 41W
 Luminaire efficacy: 22lm/W (LOR: 32%)
 Magnetic transformer 230÷240V 50Hz

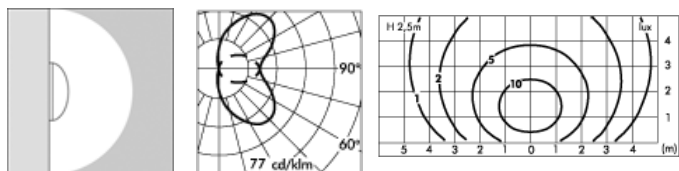

PRODUCT TYPE

Wall mounted luminaire. IP rating IP 55

MATERIAL CHARACTERISTICS

Aluminium die cast housing in EN AB-47100 (low copper content) with high resistance against corrosion. Stone wash surface treatment prior to painting process. A4 grade Stainless Steel screws with 2,5-3% molybdenum content which increases the resistance against corrosion. EPDM gaskets. Painting Process : 3 Step Process

1) Surface treatment with BONDERITE. A heavy metal free chemical surface treatment containing ceramic nano particles giving a cohesive, inorganic and highly dense protective coating. 2) PRE POLYMERIZATION a process of introducing an epoxy primer with excellent characteristics to the paint which also offers very high resistance to oxidation due to its Zinc content. 3) POLYMERIZATION a process with the application of polyester powder with high resistance against UV rays and harsh weather conditions. Resistance test protection for Marine applications for 1200h. Mechanical resistance IK 06

LIGHTING PERFORMANCE

Reflector in 99.98% pure anodized aluminium . Sand blasted glass diffuser (Vandalproof opal polycarbonate diffuser available on request). Lamp fixed position. LOR 32%

WIRING

Supply double cable entry. Isolation: CLASS I . Available colours: White (cod.01), Aluminium grey (cod.14). Weight: 4.8 Kg Glow Wire test: 960°C
Lamp not included.

This luminaire is compatible with bulbs of the energy classes: A (Regulation UE 874/2012).

EMERGENCY VERSIONS

On request the fittings could be provided with electronic ballast which operate both on AC (50/60Hz), both on DC (0Hz) voltage.
 On request fittings are available with internal battery capacity of 3 Hours.

TECHNICAL DATA SHEET ART. S.6879 - MEGAVEDO ROUND

Further information

FIXING BASE

