

## TECHNICAL DATA SHEET ART. S.5698N - MINISUIT

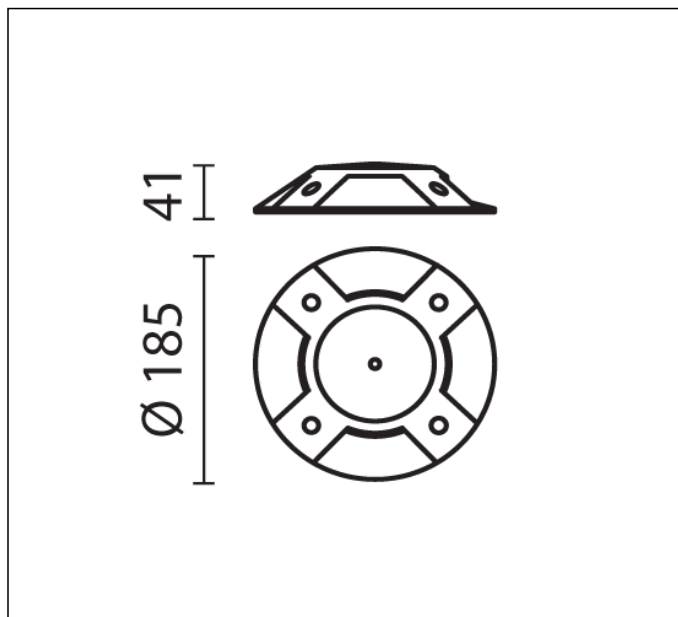

MODULES LED 4000K 230V 624lm CRI 70  
 Rated luminaire luminous flux: 190lm  
 Rated input power: 5.5W  
 Luminaire efficacy: 35lm/W  
 Electronic ballast 220÷240V 0/50/60Hz

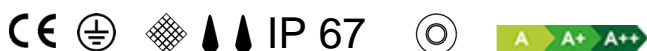
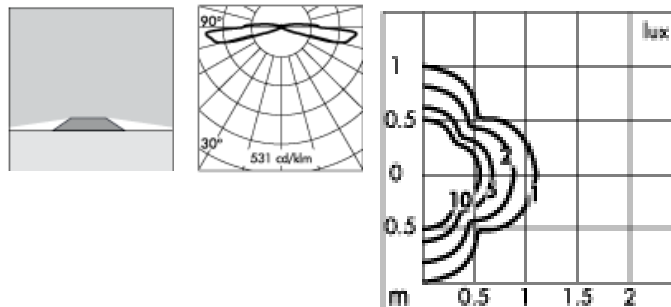

### PRODUCT TYPE

Inground drive over fitting. IP rating IP 67

### MATERIAL CHARACTERISTICS

"Copper Free" Aluminium die cast housing in EN AB-44100 with high resistance against corrosion. Stone wash surface treatment prior to painting process. Aluminium protective guard of 8 mm thickness. A4 grade Stainless Steel screws with 2,5-3% molybdenum content which increases the resistance against corrosion. Pre treated Silicone Gaskets. Painting Process : 3 Step Process

1) Surface treatment with BONDERITE. A heavy metal free chemical surface treatment containing ceramic nano particles giving a cohesive, inorganic and highly dense protective coating. 2) PRE POLYMERIZATION a process of introducing an epoxy primer with excellent characteristics to the paint which also offers very high resistance to oxidation due to its Zinc content. 3) POLYMERIZATION a process with the application of polyester powder with high resistance against UV rays and harsh weather conditions. Resistance test protection for Marine applications for 1200h. Mechanical resistance IK 10 Maximum load capacity 4000 Kg

### LIGHTING PERFORMANCE

Polycarbonate diffuser. Lamp fixed position. LOR --

### LOW SURFACE TEMPERATURE

Surface temperature of glass 37°C (Ta 25°C)

### INSTALLATION AND MAINTENANCE

FOR APPLICATIONS EXCLUDING DRIVEWAYS AREAS : SUIT is installed without any anchor flange. FOR APPLICATIONS IN DRIVEWAYS AREAS: SUIT is installed with the drive over anchor flange ( Art. S.5690/S.5699 ). Driveover 4000 Kg at 10 Km/h through the use of the anchor flange to the ground.

### WIRING

Supply 5m cable section type H07RN-F sealed with B component epoxy resin, wired internally protected by silicon sheaths. Isolation: CLASS I . Available colours: Aluminium grey (cod.14). Weight: 2.28 Kg Glow Wire test: --

### L.E.D circuit included.

### MINISUIT/SUIT PATENTED, REGISTERED DESIGN

This luminaire contains built-in LED modules with energy class: A, A+, A++. In case of damage or malfunction please contact the manufacturer to receive additional instructions on how to replace and relative spare parts to order. The LED modules cannot be handled in the luminaire by the end user (Regulation UE 874/2012).

LED circuit boards are engineered accordingly to actual Lumen Maintenance regulation (LM80) and Technical Memorandum (TM21) where uniformity and quality of light is 50.000 hours referred to L70 B20 Ta 25°C.

Lifecycle refers to LED circuit boards only, all others components of the luminaire are excluded.

### EMERGENCY VERSIONS

The fittings operates both on AC ( 50/60Hz ) and DC ( 0Hz ) voltage.

## TECHNICAL DATA SHEET ART. S.5698N - MINISUIT ACCESSORIES

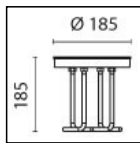

**S.5699**  
**ANCHOR FLANGE TO BE CEMENTED TO THE GROUND**

For applications in driveways areas, the luminaires must be installed with its proper anchor flange.

The flange is provided with the necessary fixing A4 screws in stainless steel.