

TECHNICAL DATA SHEET ART. S.5689 - SPARKS

Available until 31/12/2017 but subject to stock levels

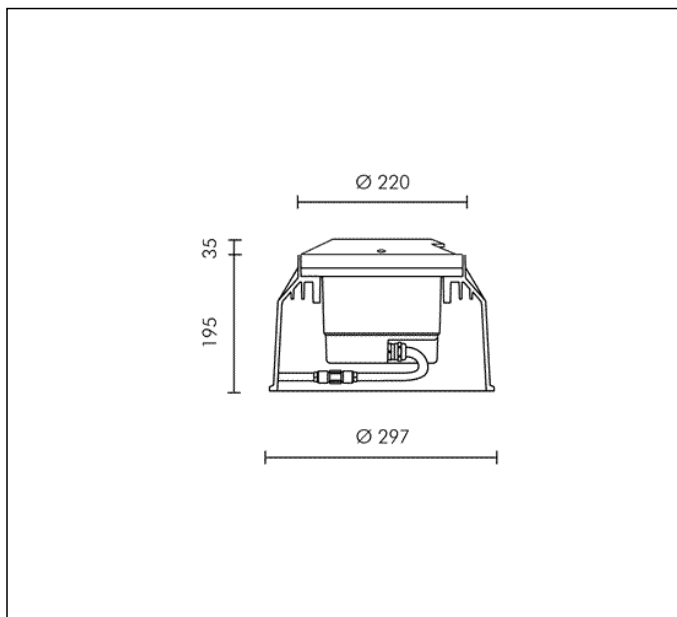

TC-T 18W Gx24d-2 1200lm
 Rated luminaire luminous flux: 24lm
 Rated input power: 22W
 Luminaire efficacy: 1lm/W (LOR: 2%)
 Magnetic transformer

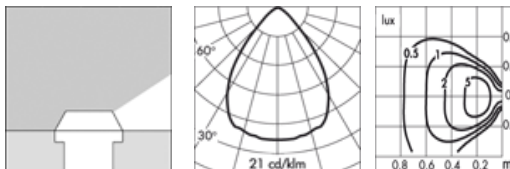

PRODUCT TYPE

Inground drive over fitting. Recessing depth 195 mm. IP rating IP 67

MATERIAL CHARACTERISTICS

"Copper Free" Aluminium die cast housing in EN AB-44100 with high resistance against corrosion. Stone wash surface treatment prior to painting process. Aluminium protective guard of 8 mm thickness. A4 grade Stainless Steel screws with 2,5-3% molybdenum content which increases the resistance against corrosion. Pre treated Silicone Gaskets. Painting Process : 3 Step Process

1) Surface treatment with BONDERITE. A heavy metal free chemical surface treatment containing ceramic nano particles giving a cohesive, inorganic and highly dense protective coating. 2) PRE POLYMERIZATION a process of introducing an epoxy primer with excellent characteristics to the paint which also offers very high resistance to oxidation due to its Zinc content. 3) POLYMERIZATION a process with the application of polyester powder with high resistance against UV rays and harsh weather conditions. Resistance test protection for Marine applications for 1200h. Mechanical resistance IK 10 Maximum load capacity 2000 Kg

LIGHTING PERFORMANCE

Toughened prisms glass diffuser. Lamp fixed position. LOR 2%

LOW SURFACE TEMPERATURE

Surface temperature of glass 39°C (Ta 25°C)

RECESSING BOX

Recessing box in Polypropylene with cable entry on all 4 sides also allows: 1) Easy wiring; 2) Cable management for fast connector; 3) Easy access to the fitting for maintenance purposes.

WIRING

Supply 0.5m cable section type H07RN-F secured by cable gland PG 13.5 (Ø 6÷12 mm) and sealed with B component epoxy resin, wired internally protected by silicon sheaths. Front re-lamping without removing the complete fitting. Isolation: CLASS I. Available colours: Aluminium grey (cod.14). Weight: 4.7 Kg Glow Wire test: --

Lamp included.

This luminaire is compatible with bulbs of the energy classes: B. The luminaire is sold with a bulb of the energy class: B (Regulation UE 874/2012).

**TECHNICAL DATA SHEET ART. S.5689 - SPARKS
INCLUDED ACCESSOIRES**



FAST CONNECTOR INCLUDED