

TECHNICAL DATA SHEET ART. S.4937.19 - MEGARING h. 500mm

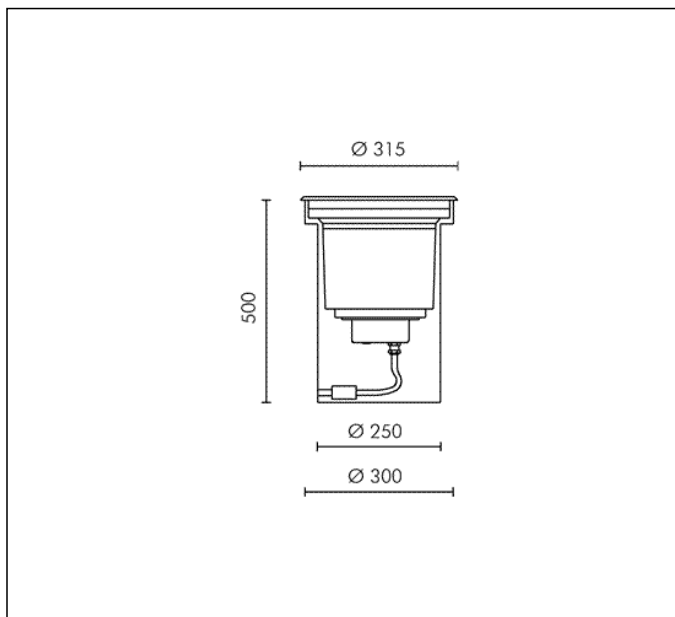

HIT-CRI 70W CLEAR G12 6500lm
 Rated luminaire luminous flux: 2925lm
 Rated input power: 84W
 Luminaire efficacy: 35lm/W (LOR: 45%)
 Magnetic transformer 230÷240V 50Hz
 EEI=A3, LOSSES=12.2W

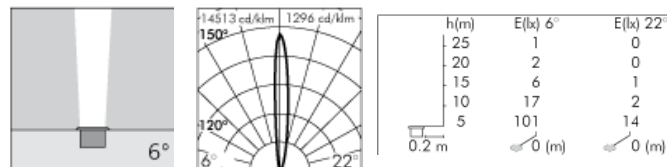

PRODUCT TYPE

Inground drive over fitting. Recessing depth 500 mm. IP rating IP 67

MATERIAL CHARACTERISTICS

"Copper Free" Aluminium die cast housing in EN AB-44100 with high resistance against corrosion. Stone wash surface treatment prior to painting process. 3 mm thick front trim in Stainless Steel - Grade AISI 316L with 2,5 -3% molybdenum content, with high resistance against corrosion. A4 grade Stainless Steel screws with 2,5-3% molybdenum content which increases the resistance against corrosion. Pre treated Silicone Gaskets. Painting Process : 3 Step Process

1) Surface treatment with BONDERITE. A heavy metal free chemical surface treatment containing ceramic nano particles giving a cohesive, inorganic and highly dense protective coating. 2) PRE POLYMERIZATION a process of introducing an epoxy primer with excellent characteristics to the paint which also offers very high resistance to oxidation due to its Zinc content. 3) POLYMERIZATION a process with the application of polyester powder with high resistance against UV rays and harsh weather conditions. Resistance test protection for Marine applications for 1200h. Mechanical resistance IK 10 Maximum load capacity 5000 Kg

LIGHTING PERFORMANCE

Reflector in 99.98% pure anodized aluminium . semiacid-etched Toughened glass 19mm thick. Lamp adjustable ±15° position. LOR 45% Compact electronic ballast to guarantee better lamp stability, lifetime and reduced energy consumption.

LOW SURFACE TEMPERATURE

Anticaloric filter. Surface temperature of glass 70°C (Ta 25°C) Electronic Ballast generating less heat. Specific layout of internal components allow for better heat dissipation therefore limiting the temperature generated inside the fitting.

RECESSING BOX

Recessing box in Polypropylene with cable entry on all 4 sides also allows: 1) Easy wiring; 2) Cable management for fast connector; 3) Easy access to the fitting for maintenance purposes.

WIRING

Supply 0.5m cable section type H07RN-F secured by cable gland PG 13.5 (Ø 6÷12 mm) and sealed with B component epoxy resin, wired internally protected by silicon sheaths. Fast connector M20 (Ø 5÷14 mm) supplied as standard for single cable connection . Connector housed inside the recessing box . Front re-lamping without removing the complete fitting . Isolation: CLASS I . Available colours: Stainless steel (cod.19). Weight: 11.1 Kg Glow Wire test: 750°C

Lamp included.

This luminaire is compatible with bulbs of the energy classes: A+. The luminaire is sold with a bulb of the energy class: A+ (Regulation UE 874/2012).

TECHNICAL DATA SHEET ART. S.4937.19 - MEGARING h. 500mm INCLUDED ACCESSOIRES



FAST CONNECTOR INCLUDED

ACCESSORIES



S.5505

ANTI-GLARE SHIELD

Only for HIT-CRI 35W/70W G12 versions with 6°/16° reflector and semi-acid etched glass.