

TECHNICAL DATA SHEET ART. S.3075N - MOVIT SQUARE 320mm

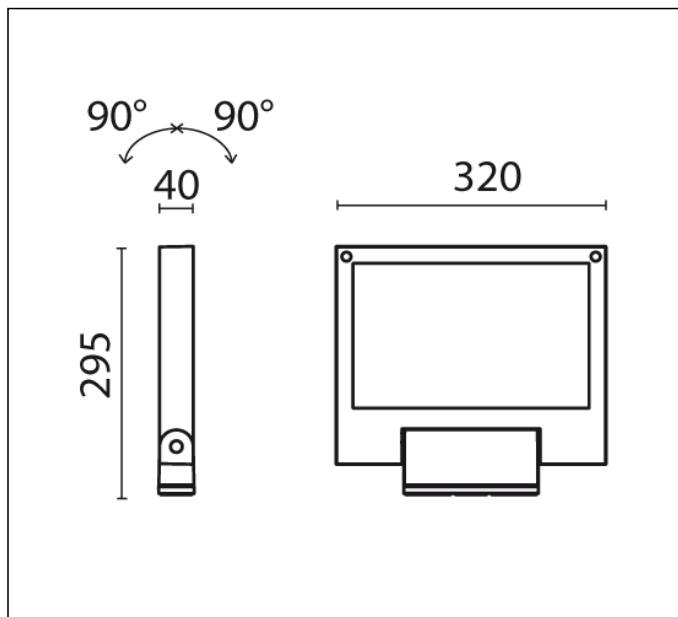

MODULES LED 4000K 230V 4618lm CRI 90 MacAdam step 3
 Rated luminaire luminous flux: 4004lm
 Rated input power: 42W
 Luminaire efficacy: 95lm/W
 Electronic ballast 220÷240V 0/50/60Hz

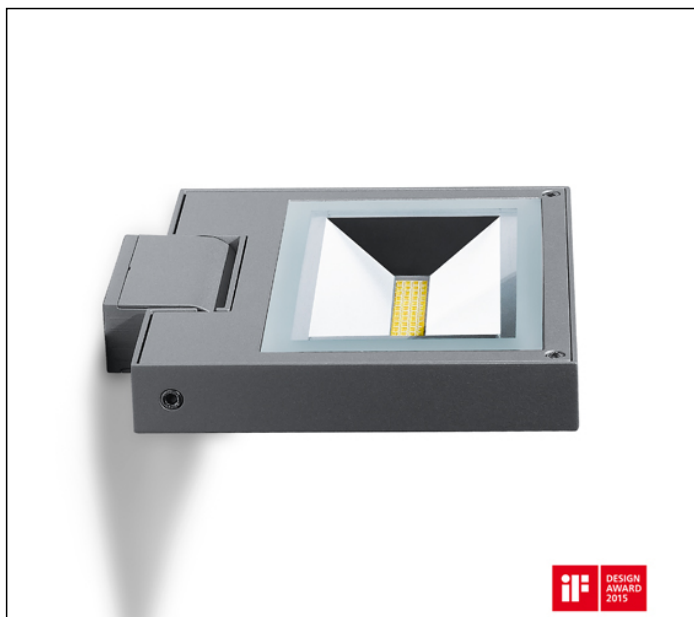
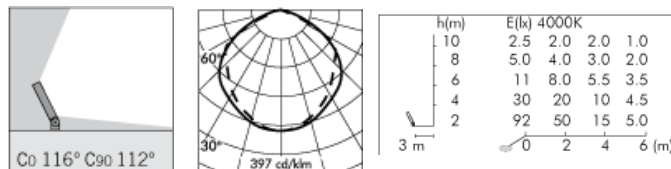

Fixture available with integral DALI driver on request with surcharge.

PRODUCT TYPE

Projector. IP rating IP 65

MATERIAL CHARACTERISTICS

Die-cast EN AB-47100 aluminium housing with high corrosion resistance. Extruded EN AW-6060 aluminium structure (arm version) with high corrosion resistance. Stone wash surface treatment prior to painting process. A4 grade Stainless Steel screws with 2,5-3% molybdenum content which increases the resistance against corrosion. Silicone gaskets. Painting Process : 3 Step Process

1) Surface treatment with BONDERITE. A heavy metal free chemical surface treatment containing ceramic nano particles giving a cohesive, inorganic and highly dense protective coating. 2) PRE POLYMERIZATION a process of introducing an epoxy primer with excellent characteristics to the paint which also offers very high resistance to oxidation due to its Zinc content. 3) POLYMERIZATION a process with the application of polyester powder with high resistance against UV rays and harsh weather conditions. Resistance test protection for Marine applications for 1200h. Mechanical resistance IK 10

LIGHTING PERFORMANCE

Reflector in 99.98% pure anodized aluminium HI-GRADE . Clear toughened glass. LOR --

INSTALLATION AND MAINTENANCE

The tempered front glass diffuser is fixed externally to the fitting through silicon resin, perfectly flush with the front ring. Water and dirt deposits that can disturb the lighting performance of the projector can easily flow away. The pre-wired connecting wall plaque and its fast connector make the installation and maintenance process quick, easy and safe.

WIRING

Supplied with a 1,5m pre-wired H05RN-F cable (0,1m for MOVIT 320mm) and fast connector . Isolation: CLASS I . Available colours: White (cod.01), Aluminium grey (cod.14). Weight: 4.1 Kg Glow Wire test: --

Lamp included.

MOVIT REGISTERED DESIGN

This luminaire contains built-in LED modules with energy class: A, A+, A++. In case of damage or malfunction please contact the manufacturer to receive additional instructions on how to replace and relative spare parts to order. The LED modules cannot be handled in the luminaire by the end user (Regulation UE 874/2012).

LED circuit boards are engineered accordingly to actual Lumen Maintenance regulation (LM80) and Technical Memorandum (TM21) where uniformity and quality of light is 50.000 hours referred to L70 B20 Ta 25°C.

Lifecycle refers to LED circuit boards only, all others components of the luminaire are excluded.

EMERGENCY VERSIONS

The fittings operates both on AC (50/60Hz) and DC (0Hz) voltage.

TECHNICAL DATA SHEET ART. S.3075N - MOVIT SQUARE 320mm ACCESSORIES



S.3079 STAKE

In polypropylene
Colour: black (code .09)
The 90 mm upper part must stay out of the ground level, according with the norms.



S.3045 ACCESSORY DOUBLE MOUNT POLE Ø60 and Ø76mm

Product is suitable for installation on SIMES poles Ø60mm Art.S.2842-S.2843 and Ø76mm Art.S.2844-S.2845

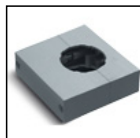

S.3044 ACCESSORY SINGLE MOUNT POLE Ø60 and Ø76mm

Product is suitable for installation on SIMES poles Ø60mm Art.S.2842-S.2843 and Ø76mm Art.S.2844-S.2845

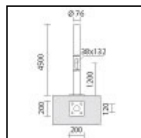

S.2845 Ø76mm CYLINDRICAL POLE WITH BASE

Cylindrical shaped poles consisting of: straight circular section shaft, Ø 76mm, 4mm in thickness, total length 4,50m , single section built by using longitudinally welded tubes by induction welding (ERW) UNI EN 10219-2-ISO 4200

Suitable for installation to a planted root flange through a base plate in steel S355JO Footstall dimension can be calculated according to your country norms and ground properties.

The grade of steel used is S235JR (Fe360B) with material characteristics as per normative UNI EN 10025; The surface protection treatment is done through hot dip galvanization.

Painting Process: PRE POLYMERIZATION a process of introducing an epoxy primer with excellent characteristics to the paint which also offers very high resistance to oxidation due to its Zinc content. POLYMERIZATION a process with the application of polyester powder with high resistance against UV rays and harsh weather conditions. Resistance test protection for Marine applications for 1500h.

Including inspection door, terminal cable block and fuse.
TO BE USED WITH THE FOLLOWING ACCESSORIES:
S.2849 PLANTED ROOT for CYLINDRICAL POLE

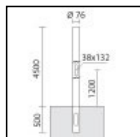

S.2844 Ø76mm CYLINDRICAL POLE TO BE BURIED

Cylindrical shaped poles consisting of: straight circular section shaft, Ø 76mm, 4mm in thickness, total length 5,00m , single section built by using longitudinally welded tubes by induction welding (ERW) UNI EN 10219-2-ISO 4200

Suitable for ground recessed installation to a cement base 0,5m : Suggested reinforced concrete footstall dimension 0,7m x 0,7m h 0,7m. Footstall dimension can be calculated according to your country norms and ground properties.

The grade of steel used is S235JR (Fe360B) with material characteristics as per normative UNI EN 10025; The surface protection treatment is done through hot dip galvanization.

Painting Process: PRE POLYMERIZATION a process of introducing an epoxy primer with excellent characteristics to the paint which also offers very high resistance to oxidation due to its Zinc content. POLYMERIZATION a process with the application of polyester powder with high resistance against UV rays and harsh weather conditions. Resistance test protection for Marine applications for 1500h.

Including inspection door, terminal cable block and fuse.

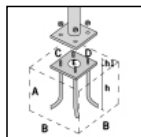

S.2849 PLANTED ROOT for CYLINDRICAL POLE

C= 200mm, D=200mm E=Ø80mm, h=407mm, h1=90mm and bolts in galvanized steel with M16 threads. Suggested reinforced concrete footstall dimension **:

A = 0.7 m
B = 0.7 m

**Footstall dimension can be calculated according to your country norms and ground properties.

TO BE USED WITH THE FOLLOWING ACCESSORIES:
S.2800, S.2801, S.2812, S.2813, S.2843, S.2845
CYLINDRICAL POLE

TECHNICAL DATA SHEET ART. S.3075N - MOVIT SQUARE 320mm ACCESSORIES

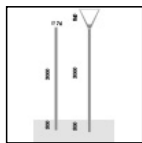

S.2812
Ø 76 mm CYLINDRICAL POLE TO BE BURIED
 Cylindrical shaped poles consisting of: straight circular section shaft, Ø 76mm, 3mm in thickness, total length 3,50m, single section built by using longitudinally welded tubes by induction welding (ERW) UNI EN 10219-2-ISO 4200

Suitable for ground recessed installation to a cement base 0,50m: Suggested reinforced concrete footstall dimension 1m x1m h 0,7m. Footstall dimension can be calculated according to your country norms and ground properties.

The grade of steel used is S235JR (Fe360B) with material characteristics as per normative UNI EN 10025; Painting Process: PRE POLYMERIZATION a process of introducing an epoxy primer with excellent characteristics to the paint which also offers very high resistance to oxidation due to its Zinc content. POLYMERIZATION a process with the application of polyester powder with high resistance against UV rays and harsh weather conditions. Resistance test protection for Marine applications for 1500h.

Including inspection door, terminal cable block and fuse.

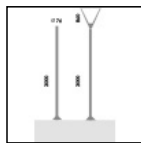

S.2813
Ø 76mm CYLINDRICAL POLE WITH BASE
 Cylindrical shaped poles consisting of: straight circular section shaft, Ø 76mm, 3mm in thickness, total length 3,00m , single section built by using longitudinally welded tubes by induction welding (ERW) UNI EN 10219-2-ISO 4200

Suitable for installation to a planted root flange through a base plate 250mm x250mm x12mm in steel S355JO : Suggested reinforced concrete footstall dimension 1m x 1m h 0,7m. Footstall dimension can be calculated according to your country norms and ground properties.

The grade of steel used is S235JR (Fe360B) with material characteristics as per normative UNI EN 10025; The surface protection treatment is done through hot dip galvanization.

Painting Process: PRE POLYMERIZATION a process of introducing an epoxy primer with excellent characteristics to the paint which also offers very high resistance to oxidation due to its Zinc content. POLYMERIZATION a process with the application of polyester powder with high resistance against UV rays and harsh weather conditions. Resistance test protection for Marine applications for 1500h.

Including inspection door, terminal cable block and fuse.

TO BE USED WITH THE FOLLOWING ACCESSORIES: S.2849 PLANTED ROOT for CYLINDRICAL POLE

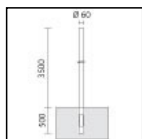

S.2842
Ø60mm CYLINDRICAL POLE TO BE BURIED
 Cylindrical shaped poles consisting of: straight circular section shaft, Ø 60mm, 4mm in thickness, total length 4,00m , single section built by using longitudinally welded tubes by induction welding (ERW) UNI EN 10219-2-ISO 4200

Suitable for ground recessed installation to a cement base 0,50m : Suggested reinforced concrete footstall dimension 0,7m x 0,7m h 0,7m. Footstall dimension can be calculated according to your country norms and ground properties.

The grade of steel used is S235JR (Fe360B) with material characteristics as per normative UNI EN 10025; The surface protection treatment is done through hot dip galvanization.

Painting Process: PRE POLYMERIZATION a process of introducing an epoxy primer with excellent characteristics to the paint which also offers very high resistance to oxidation due to its Zinc content. POLYMERIZATION a process with the application of polyester powder with high resistance against UV rays and harsh weather conditions. Resistance test protection for Marine applications for 1500h.

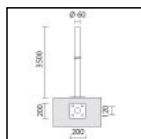

S.2843
Ø60mm CYLINDRICAL POLE WITH BASE
 Cylindrical shaped poles consisting of: straight circular section shaft, Ø 60mm, 4mm in thickness, total length 3,50m , single section built by using longitudinally welded tubes by induction welding (ERW) UNI EN 10219-2-ISO 4200

Suitable for installation to a planted root flange through a base plate in steel S355JO Footstall dimension can be calculated according to your country norms and ground properties.

The grade of steel used is S235JR (Fe360B) with material characteristics as per normative UNI EN 10025; The surface protection treatment is done through hot dip galvanization.

Painting Process: PRE POLYMERIZATION a process of introducing an epoxy primer with excellent characteristics to the paint which also offers very high resistance to oxidation due to its Zinc content. POLYMERIZATION a process with the application of polyester powder with high resistance against UV rays and harsh weather conditions. Resistance test protection for Marine applications for 1500h.

TO BE USED WITH THE FOLLOWING ACCESSORIES: S.2849 PLANTED ROOT for CYLINDRICAL POLE

Further information

FIXING BASE

