

## TECHNICAL DATA SHEET ART. S.3005N - MOVIT RECTANGULAR 130mm

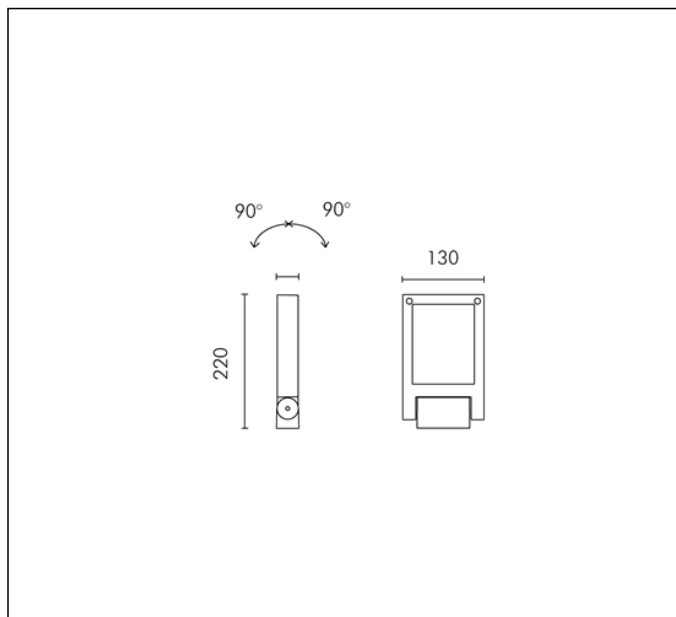

MODULES LED 4000K 230V 900lm CRI 90 MacAdam step 3  
 Rated luminaire luminous flux: 707lm  
 Rated input power: 9W  
 Luminaire efficacy: 79lm/W  
 Electronic ballast 220÷240V 50/60Hz

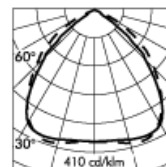
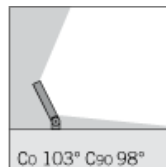

h(m)	E(lx) 4000K			
10	0.5	0.5	0.5	0.0
8	1.0	1.0	1.0	0.5
6	3.0	2.5	1.0	0.5
4	7.5	6.0	2.0	0.5
2	19	12	2.5	0.0
3 m	0	2	4	6 (m)



### PRODUCT TYPE

Projector. IP rating IP 65

### MATERIAL CHARACTERISTICS

Die-cast EN AB-47100 aluminium housing with high corrosion resistance. Extruded EN AW-6060 aluminium structure (arm version) with high corrosion resistance. Stone wash surface treatment prior to painting process. A4 grade Stainless Steel screws with 2,5-3% molybdenum content which increases the resistance against corrosion. Silicone gaskets. Painting Process : 3 Step Process

1) Surface treatment with BONDERITE. A heavy metal free chemical surface treatment containing ceramic nano particles giving a cohesive, inorganic and highly dense protective coating. 2) PRE POLYMERIZATION a process of introducing an epoxy primer with excellent characteristics to the paint which also offers very high resistance to oxidation due to its Zinc content. 3) POLYMERIZATION a process with the application of polyester powder with high resistance against UV rays and harsh weather conditions. Resistance test protection for Marine applications for 1200h. Mechanical resistance IK 09

### LIGHTING PERFORMANCE

Reflector in 99.98% pure anodized aluminium HI-GRADE . Clear toughened glass. LOR --

### INSTALLATION AND MAINTENANCE

The tempered front glass diffuser is fixed externally to the fitting through silicon resin, perfectly flush with the front ring. Water and dirt deposits that can disturb the lighting performance of the projector can easily flow away. The pre-wired connecting wall plaque and its fast connector make the installation and maintenance process quick, easy and safe.

### WIRING

Supplied with a 1,5m pre-wired H05RN-F cable ( 0,1m for MOVIT 320mm ) and fast connector . Isolation: CLASS I . Available colours: White (cod.01), Aluminium grey (cod.14). Weight: 1.4 Kg Glow Wire test: --

Lamp included.

### MOVIT REGISTERED DESIGN

This luminaire contains built-in LED modules with energy class: A, A+, A++. In case of damage or malfunction please contact the manufacturer to receive additional instructions on how to replace and relative spare parts to order. The LED modules cannot be handled in the luminaire by the end user (Regulation UE 874/2012).

LED circuit boards are engineered accordingly to actual Lumen Maintenance regulation (LM80) and Technical Memorandum (TM21) where uniformity and quality of light is 50.000 hours referred to L70 B20 Ta 25°C.

Lifecycle refers to LED circuit boards only, all others components of the luminaire are excluded.

## TECHNICAL DATA SHEET ART. S.3005N - MOVIT RECTANGULAR 130mm ACCESSORIES



### S.3049 STAKE

In polypropylene  
Colour: black (code .09)  
The 100 mm upper part must stay out of the ground level, according with the norms.

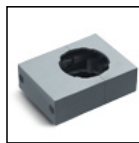

### S.3046 ACCESSORY SINGLE MOUNT POLE Ø60mm

Product is suitable for installation on SIMES poles Ø60mm Art.S.2842-S.2843



### S.3047 ACCESSORY DOUBLE MOUNT POLE Ø60mm

Product is suitable for installation on SIMES poles Ø60mm Art.S.2842-S.2843

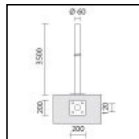

### S.2843 Ø60mm CYLINDRICAL POLE WITH BASE

Cylindrical shaped poles consisting of: straight circular section shaft, Ø 60mm, 4mm in thickness, total length 3,50m , single section built by using longitudinally welded tubes by induction welding (ERW) UNI EN 10219-2-ISO 4200

Suitable for installation to a planted root flange through a base plate in steel S355JO Footstall dimension can be calculated according to your country norms and ground properties.

The grade of steel used is S235JR (Fe360B) with material characteristics as per normative UNI EN 10025; The surface protection treatment is done through hot dip galvanization.

Painting Process: PRE POLYMERIZATION a process of introducing an epoxy primer with excellent characteristics to the paint which also offers very high resistance to oxidation due to its Zinc content. POLYMERIZATION a process with the application of polyester powder with high resistance against UV rays and harsh weather conditions. Resistance test protection for Marine applications for 1500h.

TO BE USED WITH THE FOLLOWING ACCESSORIES:  
S.2849 PLANTED ROOT for CYLINDRICAL POLE

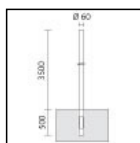

### S.2842 Ø60mm CYLINDRICAL POLE TO BE BURIED

Cylindrical shaped poles consisting of: straight circular section shaft, Ø 60mm, 4mm in thickness, total length 4,00m , single section built by using longitudinally welded tubes by induction welding (ERW) UNI EN 10219-2-ISO 4200

Suitable for ground recessed installation to a cement base 0,50m : Suggested reinforced concrete footstall dimension 0,7m x 0,7m h 0,7m. Footstall dimension can be calculated according to your country norms and ground properties.

The grade of steel used is S235JR (Fe360B) with material characteristics as per normative UNI EN 10025; The surface protection treatment is done through hot dip galvanization.

Painting Process: PRE POLYMERIZATION a process of introducing an epoxy primer with excellent characteristics to the paint which also offers very high resistance to oxidation due to its Zinc content. POLYMERIZATION a process with the application of polyester powder with high resistance against UV rays and harsh weather conditions. Resistance test protection for Marine applications for 1500h.

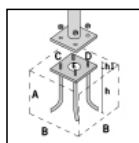

### S.2849 PLANTED ROOT for CYLINDRICAL POLE

C= 200mm, D=200mm E=Ø80mm, h=407mm, h1=90mm and bolts in galvanized steel with M16 threads. Suggested reinforced concrete footstall dimension \*\*:

A = 0.7 m  
B = 0.7 m

\*\*Footstall dimension can be calculated according to your country norms and ground properties.

TO BE USED WITH THE FOLLOWING ACCESSORIES:  
S.2800, S.2801, S.2812, S.2813, S.2843, S.2845  
CYLINDRICAL POLE