

TECHNICAL DATA SHEET ART. S.2366W - CONTINUOUS ROD COMFORT RECESSED

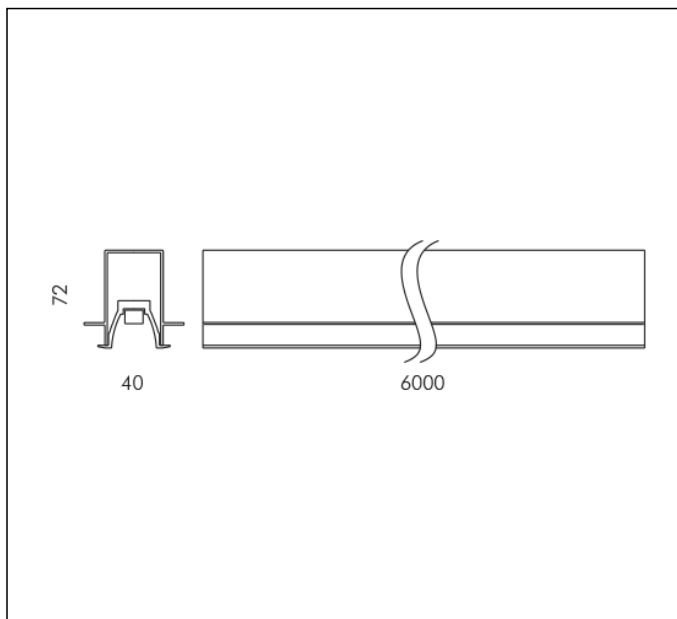

MODULES LED 3000K 24V 4800lm CRI 90
 Rated luminaire luminous flux: 4800lm
 Rated input power: 69W
 Luminaire efficacy: 70lm/W
 Without transformer

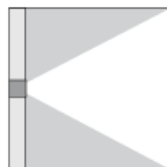

PRODUCT TYPE

Wall mounted luminaire. IP rating IP 67

MATERIAL CHARACTERISTICS

Fixing base in extruded anodized EN AW-6060 aluminium housing (copper free) with high corrosion resistance. Transparent silicone end caps for LED circuit and aluminium EN AW-47100 caps for the extruded parts. Mechanical resistance IK 08 Maximum load capacity --

LIGHTING PERFORMANCE

Continuous light source made of opal silicone. Lamp fixed position. LOR --

INSTALLATION AND MAINTENANCE

Cuttable sections of 5cm: The light source and the aluminium profile of CONTINUOUS ROD can be easily sectioned. The circuitry length may be reduced to sections of 5cm and multiples. The lighting body is supplied in modules of 1, 2 or 3m, joinable up to the desired length, while the light source is supplied in a maximum length of 6m. 45° Application: Applications at an edge only for COMFORT versions. The aluminium profile must be cut at 45° (please refer to the explanations reported on the instruction sheet).

WIRING

Supply 0.5m cable section type H07RN-F. Isolation: CLASS III. Available colours: White (cod.01), Aluminium grey (cod.14). Weight: Kg Glow Wire test: --
Lamp included.

This luminaire contains built-in LED modules with energy class: A, A+, A++. In case of damage or malfunction please contact the manufacturer to receive additional instructions on how to replace and relative spare parts to order. The LED modules cannot be handled in the luminaire by the end user (Regulation UE 874/2012).

LED circuit boards are engineered accordingly to actual Lumen Maintenance regulation (LM80) and Technical Memorandum (TM21) where uniformity and quality of light is 50.000 hours referred to L70 B20 Ta 25°C.

Lifecycle refers to LED circuit boards only, all others components of the luminaire are excluded.

EMERGENCY VERSIONS

The fittings operates both on AC (50/60Hz) and DC (0Hz) voltage.

TECHNICAL DATA SHEET ART. S.2366W - CONTINUOUS ROD COMFORT RECESSED ACCESSORIES



S.3402
REMOTE POWER SUPPLY DIMMABLE 40W IP67
Dimmable 1-10V for monochromatic LED
40W 240V/24V DC
IP67
The Total power of all connected luminaires may not be higher than the power of the driver.
Dimensions 150x53x35mm



S.3407
REMOTE POWER SUPPLY 100W IP66
for monochromatic LED 100W 240V/24V DC.
IP66
The Total power of all connected luminaires may not be higher than the power of the driver.
Dimensions 210mm x70mm x40mm



S.3428
BOX WITH DALI REMOTE POWER SUPPLY
50W 230V/24V d.c.
Dimensions 260mm x260mm x100mm
IP55



S.3429
BOX WITH DALI REMOTE POWER SUPPLY
100W 230V/24V d.c.
Dimensions 260mm x260mm x100mm
IP55