

TECHNICAL DATA SHEET ART. S.1083 - MEGAFOCUS

Available until 31/12/2017 but subject to stock levels

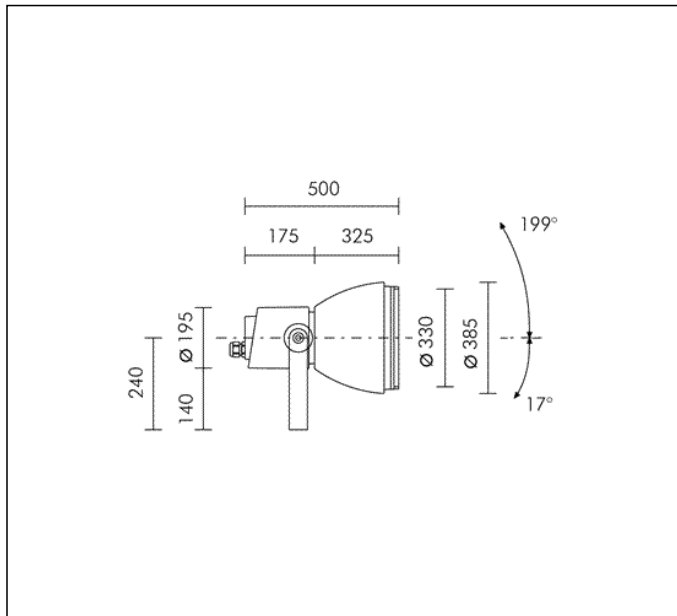
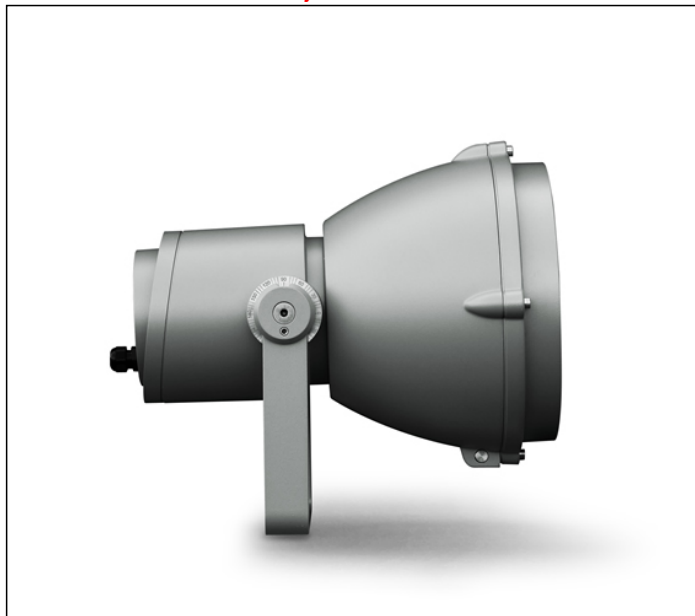

32 MODULES LED 6000K 230V 7552lm 67.2W CRI 75

Rated luminaire luminous flux: 4841lm

Rated input power: 77W

Luminaire efficacy: 63lm/W

Electronic ballast 220÷240V 50/60Hz

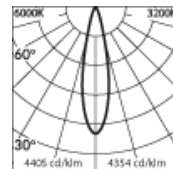
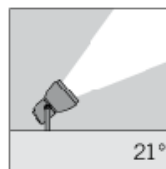

h(m)	22° Ø(m)	6000K E lx	3200K E lx
10	3.92	213	180
20	7.85	53	45
30	11.77	24	20
40	15.70	13	11
50	19.62	9	7



PRODUCT TYPE

Projector. IP rating IP 66

MATERIAL CHARACTERISTICS

Aluminium die cast housing in EN AB-47100 (low copper content) with high resistance against corrosion. Stone wash surface treatment prior to painting process. A4 grade Stainless Steel screws with 2,5-3% molybdenum content which increases the resistance against corrosion. Pre treated Silicone Gaskets. Painting Process : 3 Step Process

1) Surface treatment with BONDERITE. A heavy metal free chemical surface treatment containing ceramic nano particles giving a cohesive, inorganic and highly dense protective coating. 2) PRE POLYMERIZATION a process of introducing an epoxy primer with excellent characteristics to the paint which also offers very high resistance to oxidation due to its Zinc content. 3) POLYMERIZATION a process with the application of polyester powder with high resistance against UV rays and harsh weather conditions. Resistance test protection for Marine applications for 1200h. The 8 mm thick tempered glass diffuser is fixed to the external body by a silicon resin and positioned flush with the support ring. Mechanical resistance IK 10 Maximum load capacity --

LIGHTING PERFORMANCE

The lathed anodized reflector is composed of 99,98% pure anodized aluminium with a bright polish finish (Version with LED COB). LOR --

INSTALLATION AND MAINTENANCE

The projector is supplied with graduated ferrules in AISI 316L stainless steel on both sides of the fitting. The screws that fix the front glass holder to the main body of the projector are also in AISI 316L stainless steel with anti loss washers. The glass diffuser and front support ring are secured to the body of the projector by a pivoting hinge assembly that when opened allows for easy access to the lamp and the reflector. All the internal accessories such as lenses, coloured filters and antiglare shield are fixed to the pivoting front support ring and allow for easy access to the lamp and reflector.

WIRING

LED versions: PROTECTIONS AGAINST DISCHARGES AND HIGH VOLTAGE SPIKES, Controlgear equipped with protections against discharges and high voltage spikes on the mains: 3,5kV differential mode (L-N), 4,0kV common mode (PE). Double cable entries with PG16 (Ø 10÷14 mm) cable glands in nicked brass. Isolation: CLASS II. Available colours: Aluminium grey (cod.14). Weight: 15.7 Kg Glow Wire test: 960°C

L.E.D circuit included.

FOCUS/MEGAFOCUS REGISTERED DESIGN

This luminaire contains built-in LED modules with energy class: A, A+, A++. In case of damage or malfunction please contact the manufacturer to receive additional instructions on how to replace and relative spare parts to order. The LED modules cannot be handled in the luminaire by the end user (Regulation UE 874/2012).

LED circuit boards are engineered accordingly to actual Lumen Maintenance regulation (LM80) and Technical Memorandum (TM21) where uniformity and quality of light is 50.000 hours referred to L70 B20 Ta 25°C.

Lifecycle refers to LED circuit boards only, all others components of the luminaire are excluded.

TECHNICAL DATA SHEET ART. S.1083 - MEGAFOCUS ACCESSORIES



S.1013
FLANGE FOR POLE INSTALLATION Ø 120mm
 Flange in die-cast aluminium suitable only for Ø 120 mm poles. The flange can be used for maximum 2 projectors, one for each side.



S.1042
VISOR
 Colour: black (code 09).



S.1043
ADJUSTABLE BARN DOORS
 Every box S.1043 contains only one flap. To receive the complete system of 4 flaps you have to order n°4 S.1043. Colour: black (code 09).

Available until 31/12/2017 but subject to stock levels

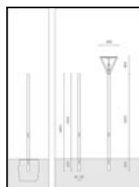

S.2826
Ø 120mm CYLINDRICAL POLE TO BE BURIED
 Cylindrical shaped poles consisting of: straight circular section shaft, Ø 120mm, 3mm in thickness, total length 4,80m , single section built by using longitudinally welded tubes by induction welding (ERW) UNI EN 10219-2-ISO 4200

Suitable for ground recessed installation to a cement base 0,60m : Suggested reinforced concrete footstall dimension 0,8m x 0,8m h 0,8m. Footstall dimension can be calculated according to your country norms and ground properties.

The grade of steel used is S235JR (Fe360B) with material characteristics as per normative UNI EN 10025; The surface protection treatment is done through hot dip galvanization.

Painting Process: PRE POLYMERIZATION a process of introducing an epoxy primer with excellent characteristics to the paint which also offers very high resistance to oxidation due to its Zinc content. POLYMERIZATION a process with the application of polyester powder with high resistance against UV rays and harsh weather conditions. Resistance test protection for Marine applications for 1500h.

Including inspection door, terminal cable block and fuse. Cap COPE2826PVC.09 already installed.

TO BE USED WITH THE FOLLOWING ACCESSORIES:
 S.2809 POLE BASE COVER

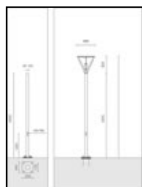

S.2846
Ø 120mm CYLINDRICAL POLE WITH BASE
 Cylindrical shaped poles consisting of: straight circular section shaft, Ø 120mm, 3mm in thickness, total length 4,20m , single section built by using longitudinally welded tubes by induction welding (ERW) UNI EN 10219-2-ISO 4200

Suitable for installation to a planted root flange through a base plate 250mm x250mm x12mm in steel S355JO : Suggested reinforced concrete footstall dimension 1m x 1m h 0,7m. Footstall dimension can be calculated according to your country norms and ground properties.

The grade of steel used is S235JR (Fe360B) with material characteristics as per normative UNI EN 10025; The surface protection treatment is done through hot dip galvanization.

Painting Process: PRE POLYMERIZATION a process of introducing an epoxy primer with excellent characteristics to the paint which also offers very high resistance to oxidation due to its Zinc content. POLYMERIZATION a process with the application of polyester powder with high resistance against UV rays and harsh weather conditions. Resistance test protection for Marine applications for 1500h.

Including inspection door, terminal cable block and fuse. Cap COPE2826PVC.09 already installed.

TO BE USED WITH THE FOLLOWING ACCESSORIES:
 S.2840 PLANTED ROOT for CYLINDRICAL POLE



S.2848
Ø 120mm CYLINDRICAL POLE WITH BASE
 Cylindrical shaped poles consisting of: straight circular section shaft, Ø 120mm, 3mm in thickness, total length 6,00m , single section built by using longitudinally welded tubes by induction welding (ERW) UNI EN 10219-2-ISO 4200

Suitable for installation to a planted root flange through a base plate 250x250x12mm in steel S355JO : Suggested reinforced concrete footstall dimension 1x1 h 0,7m. Footstall dimension can be calculated according to your country norms and ground properties.

The grade of steel used is S235JR (Fe360B) with material characteristics as per normative UNI EN 10025; The surface protection treatment is done through hot dip galvanization.

Painting Process: PRE POLYMERIZATION a process of introducing an epoxy primer with excellent characteristics to the paint which also offers very high resistance to oxidation due to its Zinc content. POLYMERIZATION a process with the application of polyester powder with high resistance against UV rays and harsh weather conditions. Resistance test protection for Marine applications for 1500h.

MINISLOT AVANT-GARDE INSTALLED ON S.2848 POLE:

Finished product total height = 7.13 m
 Cap COPE2826PVC.09 already installed.

TO BE USED WITH THE FOLLOWING ACCESSORIES:
 S.2840 PLANTED ROOT for CYLINDRICAL POLE

S.2809 POLE BASE COVER

TECHNICAL DATA SHEET ART. S.1083 - MEGAFOCUS ACCESSORIES

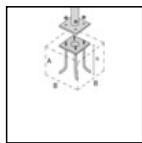

S.2840

PLANTED ROOT for CYLINDRICAL POLE

h = 470 mm and bolts in galvanized steel with M16 threads. Suggested reinforced concrete footstall dimension:

A = 0.7 m

B = 1 m

Footstall dimension can be calculated according to your country norms and ground properties.

Footstall dimension can be calculated according to your country norms and ground properties.

TO BE USED WITH THE FOLLOWING ACCESSORIES:

S.2846, S.2848 CYLINDRICAL POLE

Further information

FIXING BASE

