

## UT SPOT TRACK WALL-WASHER Ø86 DALI VERSION

<b>Number of heads</b>	1
<b>Mounting</b>	Track mounting
<b>Lamps description</b>	LED Array High Performances 32,8W 3246 lm 4000K CRI 90
<b>Voltage (V)</b>	220/240
<b>Environment</b>	Indoor
<b>Notes</b>	FLOS three-phase lighting track luminaires are designed and fully tested for tracks recommended by FLOS. Compatibility is guaranteed with three-phase track produced by Nordic Aluminium. Compatibility with Eutrac under request. FLOS three-phase DALI track luminaires are designed for Pulse DALI from Nordic Aluminium.

### OPTICAL

<b>Reflector finish</b>	Aluminum
<b>Aiming</b>	Adjustable
<b>Light distribution symmetry</b>	Symmetric
<b>Beam angle</b>	50°

### ELECTRICAL

<b>Transformer availability</b>	Included
<b>Transformer mounting</b>	Integral
<b>Transformer type</b>	Electronic dimmable dali
<b>Emergency</b>	Without
<b>Insulation class</b>	Class II

### PHYSICAL

<b>Spot diameter (mm)</b>	86
<b>Construction material</b>	Aluminium
<b>Weight (kg)</b>	1,55



### UT Spot Track Wall-Washer Ø86 Dali Version

designed by FLOS Architectural

Spotlight to be installed on 3-phase track, with LED light source. 220-240V, 50-60Hz power supply integrated.

- 09.4956.30ADA - 2204lm White
- 09.4956.14ADA - 2204lm Black

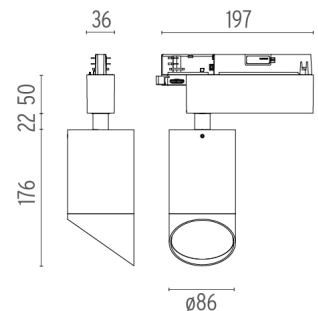

### CERTIFICATIONS

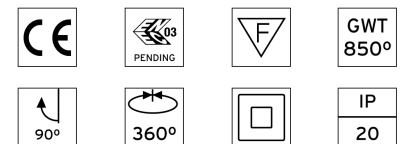

## UT Spot Track Wall-Washer Ø86 Dali Version . Lamps



**LED Array**

**Lamp category:**

LED

**Socket:**

Special base

**Lamp type:**

LED Array



### UT Spot Track Wall-Washer Ø86 Dali Version

designed by FLOS Architectural

Spotlight to be installed on 3-phase track, with LED light source. 220-240V, 50-60Hz power supply integrated.

- 09.4956.30ADA - 2204lm White
- 09.4956.14ADA - 2204lm Black

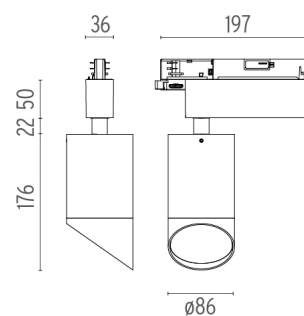

### CERTIFICATIONS

