

LIGHT SHADOW FIXED TRIM 4 SPOTS OPTIC SPOT

Mounting	Ceiling recessed
Lamps description	Power LED 10,8W 1040 lm 2700K CRI 90
Luminaire luminous flux	Extreme Cut-off. See reference number
Environment	Indoor
Notes	Pre-installation frame not required.

OPTICAL

Aiming	Fixed
Light distribution symmetry	Symmetric
Beam angle	10° Spot

ELECTRICAL

Transformer availability	Included
Transformer mounting	Remote
Transformer type	Electronic
Emergency	Without
Insulation class	Class II

PHYSICAL

Length (mm)	147
Recessed depth (mm)	75
Weight (kg)	0,34



Light Shadow Fixed Trim 4 Spots Optic Spot

designed by FLOS Architectural

Recessed integrated luminaire with 4 LED lighting spots. Remote power supply included.

	03.8828.40 - 810lm	White / White
	03.8828.14 - 810lm	Black / White
	03.8830.40 - 816lm	White / Chrome
	03.8830.14 - 816lm	Black / Chrome
	03.8831.40 - 804lm	White / Matt Gold
	03.8831.14 - 804lm	Black / Matt Gold
	03.8829.40 - 793lm	White / Black
	03.8829.14 - 793lm	Black / Black

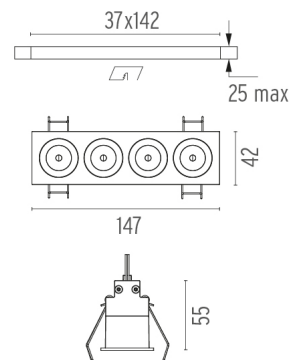

CERTIFICATIONS

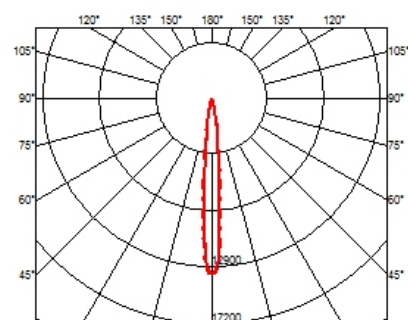
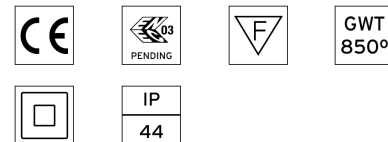

Light Shadow Fixed Trim 4 Spots Optic Spot . Lamps



Power LED

Lamp category:
LED

Socket:
Special base

Lamp type:
Power LED



Light Shadow Fixed Trim 4 Spots Optic Spot

designed by FLOS Architectural

Recessed integrated luminaire with 4 LED lighting spots. Remote power supply included.

	03.8828.40 - 810lm	White / White
	03.8828.14 - 810lm	Black / White
	03.8830.40 - 816lm	White / Chrome
	03.8830.14 - 816lm	Black / Chrome
	03.8831.40 - 804lm	White / Matt Gold
	03.8831.14 - 804lm	Black / Matt Gold
	03.8829.40 - 793lm	White / Black
	03.8829.14 - 793lm	Black / Black

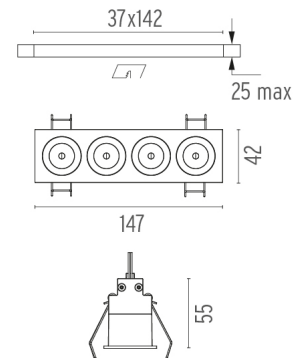

CERTIFICATIONS

