

SPOT STRUCTURE 150

Number of heads	1
Mounting	Track mounting
Lamps description	LED Array 22W 2185 lm 2700K CRI 90
Luminaire luminous flux	See reference number
Voltage (V)	48
Environment	Indoor

OPTICAL

Reflector finish	Aluminum
Aiming	Adjustable
Light distribution symmetry	Symmetric
Beam angle	22° Medium

ELECTRICAL

Transformer availability	Separate item
Transformer mounting	Remote
Transformer type	Electronic dimmable
Emergency	Without
Insulation class	Class III

PHYSICAL

Width (mm)	245
Spot diameter (mm)	57
Construction material	Aluminium
Weight (kg)	0,30

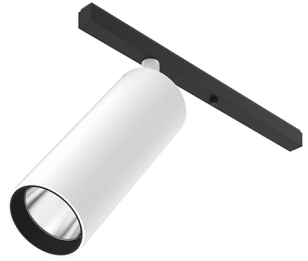

Spot Structure 150 designed by Vincent Van Duysen

<div>Accent lighting LED module to be installed in The Infra-Structure System.</div>

● 03.6902.40 - 1391lm	White
● 03.6902.14 - 1391lm	Black

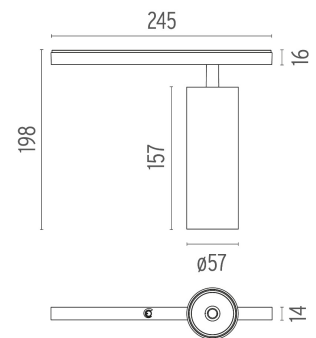

CERTIFICATIONS

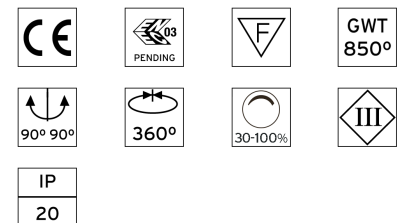

Spot Structure 150 . Accessories

Optical



● 08.8429.00

Screening Crosspiece



○ 08.8431.00

Elliptical Lens



○ 08.8432.00

Flood Lens



● 08.8428.00

Honeycomb



● 08.0526.00

Snoot Shielding Cone



Spot Structure 150 designed by Vincent Van Duysen

<div>Accent lighting LED module to be installed in The Infra-Structure System.</div>

- 03.6902.40 - 1391lm White
- 03.6902.14 - 1391lm Black

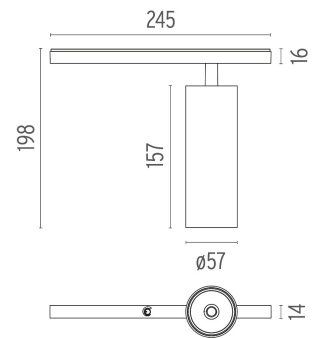

CERTIFICATIONS

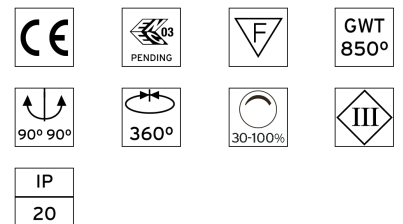

Spot Structure 150 . Lamps



LED Array

Lamp category:
LED

Socket:
Special base

Lamp type:
LED Array



Spot Structure 150
designed by Vincent Van Duysen

<div>Accent lighting LED module to be installed in The Infra-Structure System.</div>

- 03.6902.40 - 1391lm White
- 03.6902.14 - 1391lm Black

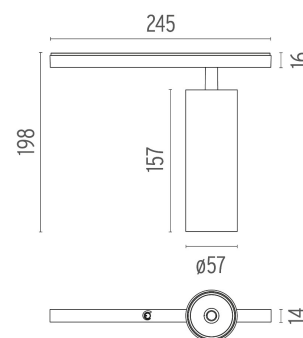

CERTIFICATIONS

