

JOHNNY I20 SEMI-RECESSED 2L SQUARE HIGH PERFORMANCE – HOUSING

Number of heads	2
Mounting	Ceiling recessed
Lamps description	LED Array DC 500 mA 18W 1870 lm 3000K CRI 90
Luminaire luminous flux	Extreme Cut-off. See reference number
Environment	Indoor

OPTICAL

Aiming	Adjustable
Light distribution symmetry	Symmetric
Beam angle	28° Medium

ELECTRICAL

Transformer availability	Separate item
Transformer mounting	Remote
Transformer type	Electronic, Electronic dimmable, Electronic dimmable I-10V, Electronic dimmable dali
Emergency	Without
Insulation class	Class III

PHYSICAL

Construction material	Aluminium
------------------------------	-----------

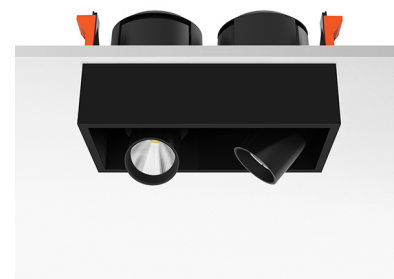

Johnny I20 Semi-Recessed 2L Square High Performance – Housing

designed by FLOS Architectural

Recessed luminaire with LED light source. Power supply not included. One driver is needed per each light source.

- 03.0802.14.Light Source - 1670lm Black
- 08.0507.40.Box White
- 08.0507.CE.Box Concrete
- 08.0507.TK.Box Teak
- 08.0507.14.Box Black
- 03.0802.40.Light Source - 1670lm White

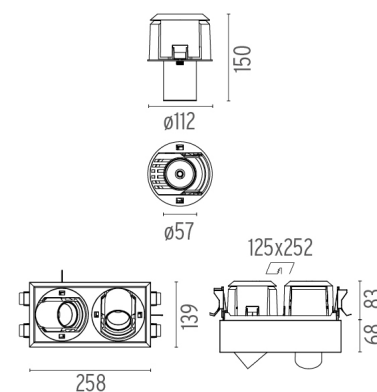

CERTIFICATIONS



Johnny 120 Semi-Recessed 2L Square High Performance – Housing . Accessories

Optical



● 08.8429.00

Screening Crosspiece



○ 08.8431.00

Elliptical Lens



○ 08.8432.00

Flood Lens



● 08.8428.00

Honeycomb



● 08.0526.00

Snoot Shielding Cone



Johnny 120 Semi-Recessed 2L Square High Performance – Housing

designed by FLOS Architectural

Recessed luminaire with LED light source. Power supply not included. One driver is needed per each light source.

- 03.0802.14.Light Source - 1670lm Black
- 08.0507.40.Box White
- 08.0507.CE.Box Concrete
- 08.0507.TK.Box Teak
- 08.0507.14.Box Black
- 03.0802.40.Light Source - 1670lm White

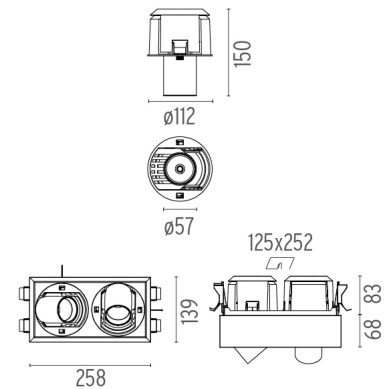

CERTIFICATIONS

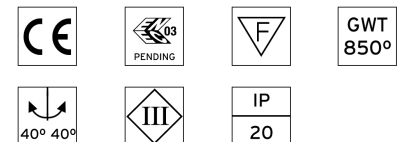

Johnny 120 Semi-Recessed 2L Square High Performance – Housing . Accessories

Power Supply



60.8536

Constant Current Power Supply for LED. 13-20W

Continuous current power supply of 13-20W, 110/240V - 50/60Hz with power current selected through adjustable 250/350/400/450/500/550/600/700mA 1-10V switch or push dimming. (Johnny 120 with accessories max 450 mA)

Maximum length of 1.5 mm² secondary conductor (m): 10

Maximum length of 2.5 mm² secondary conductor (m): 15



60.8847

Constant Current Power Supply for LED. 10-20W

Continuous current power supply of 10-20W, 110/240V - 50/60Hz with power current selected through adjustable 250/350/400/450/500/ 550/600/700 mA Dali switch. (Johnny 120 with accessories max 450 mA)

Maximum length of 1.5 mm² secondary conductor (m): 10

Maximum length of 2.5 mm² secondary conductor (m): 15



60.9073

Continuous current power supply of 13-42W (Johnny 120 with accessories max 450 mA)

Continuous current power supply of 13-42W, 220/240V - 50/60Hz with power current selected through adjustable 300/350/400/450/500/550/600/650/700/750/800/850/900/950/1000/1050 mA.

Maximum length of 1.5 mm² secondary conductor (m): 10

Maximum length of 2.5 mm² secondary conductor (m): 15



Johnny 120 Semi-Recessed 2L Square High Performance – Housing

designed by FLOS Architectural

Recessed luminaire with LED light source. Power supply not included. One driver is needed per each light source.

- 03.0802.14.Light Source - 1670lm Black
- 08.0507.40.Box White
- 08.0507.CE.Box Concrete
- 08.0507.TK.Box Teak
- 08.0507.14.Box Black
- 03.0802.40.Light Source - 1670lm White



60.9268

Constant Current Power Supply for LED. 18W (Johnny 120 with accessories max 450 mA)

Continuous current power supply of 18W, 220/240V - 50/60Hz with 450 mA supply voltage push dimming.

Maximum length of 1.5 mm² secondary conductor (m): 15

Maximum length of 2.5 mm² secondary conductor (m): 15



60.8650

Constant Current Power Supply for LED. 20W / 500 mA (Johnny 120 without accessories)

Non dimmable continuous current power supply 220/240V - 50/60Hz. (110V = 12V)

Maximum length of 1.5 mm² secondary conductor (m): 50

Maximum length of 2.5 mm² secondary conductor (m): 50



60.8534

Constant Current Power Supply for LED. 32W (Johnny 120 without accessories)

Continuous current power supply of 32W, 230/240V - 50/60Hz with power current selected through adjustable 350/500/700 mA switch by trailing and leading edge dimming or push dimming.

Maximum length of 1.5 mm² secondary conductor (m): 10

Maximum length of 2.5 mm² secondary conductor (m): 15

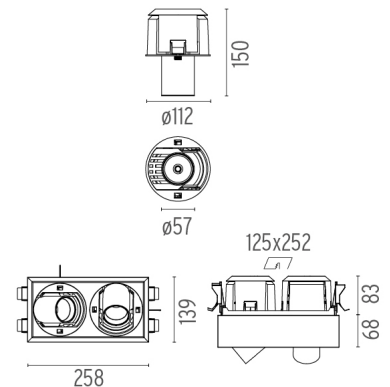

CERTIFICATIONS

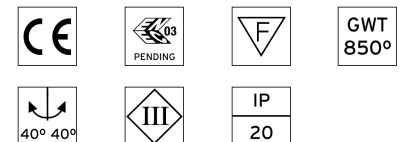

Johnny 120 Semi-Recessed 2L Square High Performance – Housing . Lamps



LED Array

Lamp category:

LED

Socket:

Special base

Lamp type:

LED Array



Johnny 120 Semi-Recessed 2L Square High Performance – Housing

designed by FLOS Architectural

Recessed luminaire with LED light source. Power supply not included. One driver is needed per each light source.

- 03.0802.14.Light Source - 1670lm Black
- 08.0507.40.Box White
- 08.0507.CE.Box Concrete
- 08.0507.TK.Box Teak
- 08.0507.14.Box Black
- 03.0802.40.Light Source - 1670lm White

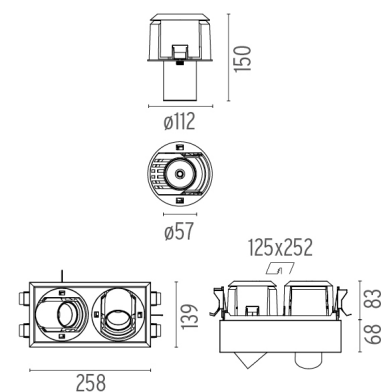

CERTIFICATIONS

