

Fabbian

50 via Santa Brigida
31020 Castelmio di Resana
Treviso, Italy Tel +39 0423 4848 fax +39 423 484395
fabbian@fabbian.com www.fabbian.com

EASY
D14F39

I **ATTENZIONE: L'APPARECCHIO D'ILLUMINAZIONE AD INCASSO DEVE ESSERE APPLICATO SU UN CONTROSOFFITO CON FORO DI 100mm, CAPACE DI CONTENERE L'INTERO APPARECCHIO. LA SICUREZZA DELL'APPARECCHIO È GARANTITA SOLO CON L'USO APPROPRIATO DELLE SEGUENTI ISTRUZIONI. CONSERVARLE CON CURA.**

AVVERTENZE

Proteggere i cavi d'alimentazione della rete con le apposite guaine in vetro silicone.
Prima di eseguire qualsiasi tipo di operazione togliere la tensione in rete.
Fare attenzione a non superare il Max di watt indicati per l'apparecchio.

L'apparecchio non deve, in nessuna circostanza, essere coperto con materiale isolante o similare.
Mai coprire l'apparecchio durante il funzionamento.

Potenza massima della lampada. 1x 18W

Attacco lampada. GX24q-2

Tipo lampada. TC-T 

Apparecchio classe II. 

Adatto al montaggio su superfici normalmente infiammabili.
Grado di protezione. (IP20 lato incassato), (IP44 lato vetro) IP20/IP44 

GB **ATTENTION: THIS BUILT IN APPLIANCE HAS TO BE COMPLETELY INTO A 100MM DIAMETRE HOLE, OF A RECESSED CEILING. THE SAFETY OF THE APPLIANCE IS GUARANTEED ONLY IF IT IS PROPERLY USED, ACCORDING TO THE FOLLOWING INSTRUCTIONS, WHICH ARE TO BE KEPT.**

WARNING

Protected the main supply cables with the special silicone-glass sheaths.
Always disconnect the power supply before installing or performing any maintenance operations.
Make attention of not exceeding the maximum watt indicated on the appliance.

The luminaire shall. Under no circumstance, be covered with insulating matting or similar
Never cover the appliance while in function.

Capacity of bulb. 1x 18W

Type of lampholder. GX24q-2

Type of bulb. TC-T 

Appliance in class II. 

Adaptable for mounting onto surfaces normally inflammable
Degree of protection (IP20 boxed side), (IP44 side glass) IP20/IP44 

D **ACHTUNG: DER UNTERGebaUTE BELEUCHTUNGSKÖRPER WIRD AN EINER HÄNGEDECKE MIT EINER ÖFFNUNG VON 100 MM ANGEBRACHT, IN WELCHER DER GESAMTE BELEUCHTUNGSKÖRPER PLATZ FINDET. DIE SICHERHEIT DIESER BELEUCHTUNGSKÖRPERS WIRD NUR DURCH DIE KORREKTE ANWENDUNG DER NACHSTEHENDEN ANWEISUNGEN GEWÄHRLEISTET. DIESE ÜSSEN DAHER SORGFÄLTIG AUFBEWAHRT WERDEN.:**

WICHTIGE HINWEISE

Die Netzversorgungskabel mit den entsprechenden Kabelmänneln aus Silikonglas schützen.
Bevor irgendwelche Arbeitsgänge ausgeführt werden, muß die Stromversorgung unterbrochen.
Achten Sie darauf, daß die auf dem Beleuchtungskörper angegebene maximale Wattzahl nicht überschritten wird.

Das Gerät muß NIE mit Isoliermaterial oder ähnlichen Materialien bedeckt werden.
Den Beleuchtungskörper während dem Betrieb nicht abdecken.

Leistung der Gluehbirne. 1x 18W

Anschluss. GX24q-2

Typ der Gluehbirne. TC-T 

Gerät der Klasse II. 

Schutzart. (IP20 geschachtelte seite), (IP44 teil glas) IP20/IP44 

Das Gerat eignet sich fuer die Montage auf normal entflammaren Oberflächen.

RU **ВНИМАНИЕ: ВСТРОЕННЫЙ ОСВЕТИТЕЛЬНЫЙ ПРИБОР ДОЛЖЕН БЫТЬ УСТАНОВЛЕН В ОТВЕРСТИЕ В ПОДВЕСНОМ ПОТОЛКЕ, ДИАМЕТРОМ 100mm, ЧТОБЫ ПОЛНОСТЬЮ ВМЕСТИТЬ ПРИБОР. БЕЗОПАСНО ОСВЕТИТЕЛЬНОГО ПРИБОРА ГАРАНТИРОВАНА ТОЛЬКО ПРИ УСЛОВИИ ЕГО ЭКСПЛУАТАЦИИ В СООТВЕТСТВИИ С ПРИВЕДЕННЫМИ НИЖЕ ИНСТРУКЦИЯМИ, КОТОРЫЕ НЕОБХОДИМО СОХРАНИТЬ.**

ВНИМАНИЕ:

Изолировать сетевые провода специальной стеклосиликоновой оплеткой.
Перед выполнением любой операции с осветительным прибором отключить напряжение в сети.
Не превышать максимально допустимую мощность, указанную для данного осветительного прибора.

The luminaire shall. Under no circumstance, be covered with insulating matting or similar material.
Никогда не накрывать осветительный прибор в рабочем режиме.

Максимальная мощность лампочки. 1x 18W

Тип цоколя лампочки. GX24q-2

Тип лампочки. TC-T 

Степень защиты. (IP20 boxed side), (IP44 side glass) IP20/IP44 

Осветительный прибор КЛАССА II. 

пригодный для установки на возгораемых поверхностях.

F **ATTENTION: L'APPAREIL D'ECLAIRAGE A ENCASTRER DOIT ÊTRE APPLIQUÉ SUR UN FAUX PLAFOND, AYANT UN ORIFICE DE 100 MM EN MESURE DE CONTENIR TOUT L'APPAREIL. LA SECURITE DE CET APPAREIL N'EST GARANTIE QUE SI L'ON RESPECTE LES INSTRUCTIONS SUIVANTES. IL EST, PAR CONSEQUENT, INDISPENSABLE DE LES CONSERVER SOIGNEUSEMENT.**

AVERTISSEMENTS

Protéger les câbles d'alimentation du secteur au moyen des gaines spéciales en verre aux silicones.
Avant d'effectuer toute opération, débrancher la tension de réseau.
Veiller à ne pas dépasser la limite maximale des watts indiquée sur l'appareil.

The luminaire shall. Under no circumstance, be covered with insulating matting or similar material.
Ne jamais couvrir l'appareil pendant son fonctionnement.

Puissance ampoule. 1x 18W

Culot. GX24q-2

Type ampoule. TC-T 

Appareil de classe II. 

Degré de protection. (IP20 coté encaissé), (IP44 coté verre) IP20/IP44 

Appareil apte au montage sur surfaces normalement inflammables.

P **ATENÇÃO: O APARELHO DE ILUMINAÇÃO DE ENCASTRAR DEVE SER APLICADO NUM TECTO FALSO, NUM ORIFÍCIO DE 100MM, CAPAZ DE CONTER TODO O APARELHO. A SEGURANÇA DO APARELHO É GARANTIDA SOMENTE SE FOREM RESPEITADAS AS INSTRUÇÕES. PORTANTO, É NECESSÁRIO CONSERVÁ-LAS.**

ADVERTÊNCIAS

Proteger os cabos de alimentação da rede com as respectivas bainhas em vidro de silicone.
Antes de fazer qualquer tipo de operação, desligar a corrente eléctrica da rede.
Prestar atenção para não superar o número de watts indicados para o aparelho.

The luminaire shall. Under no circumstance, be covered with insulating matting or similar material.
Nunca cobrir o aparelho durante o funcionamento.

Potência máxima da lâmpada. 1x 18W

Tipo de suporte da lâmpada. GX24q-2

Tipo de lâmpada. TC-T 

Aparelho de CLASSE II. 

Apropriado para ser montado em superfícies normalmente inflamáveis.
Grado de protecção. (IP20 boxed side), (IP44 side glass) IP20/IP44 

E **ATENCIÓN: EL APARATO DE ILUMINACIÓN EMPOTRABLE DEBE APLICARSE EN UN FALSO TECTO CON UN ORIFICIO DE 100MM, CAPAZ DE CONTENER EL ENTERO APARATO. LA SEGURIDAD DEL APARATO ESTÁ GARANTIZADA SÓLO POR UN USO ADECUADO DE LAS SIGUIENTES INSTRUCCIONES; POR CONSIGUIENTE, ES PRECISO CONSERVARLAS.**

ADVERTENCIAS

Proteger los cables de alimentación de la red con las especiales vainas en cristal de silicio (vidrio silicona).
Antes de llevar a cabo cualquier tipo de operación, desconectar la tensión de la red.
Prestar atención a no superar el máximo de los vatios indicados en el aparato.

The luminaire shall. Under no circumstance, be covered with insulating matting or similar material.
No cubrir jamás el aparato durante el funcionamiento.

Potencia máxima de la bombilla. 1x 18W

Casquillo de la bombilla. GX24q-2

Tipo de bombilla. TC-T 

Aparato CLASE II. 

Aparato adecuado para el montaje en superficies normalmente inflamables.
Grado de protección. (IP20 boxed side), (IP44 side glass) IP20/IP44 

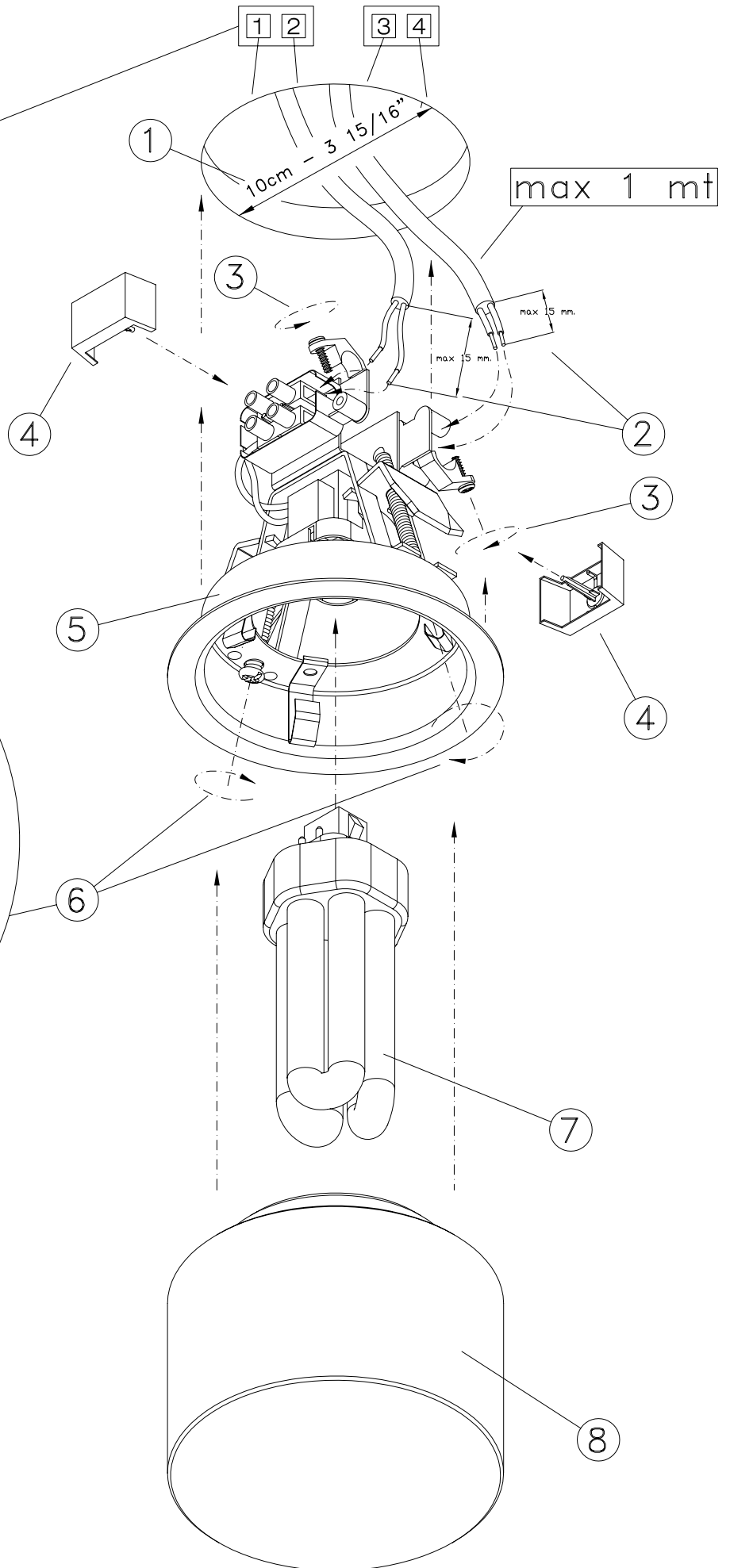
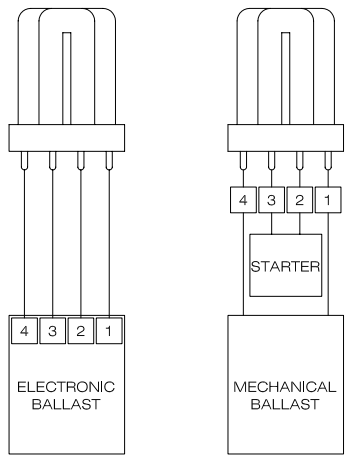

- Procedere al montaggio seguendo le operazioni in ordine numerico progressivo.
- Proceed with assembling following the operations in progressive numerical order.
- Arbeitsgänge in numerischer Ordnung ausführen, um das Gerät zu installieren.
- Il faut procéder a le montage exécutant les opératoins par l'ordre numerique progressif.