

BEGA**24 249**

Recessed ceiling downlight

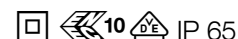

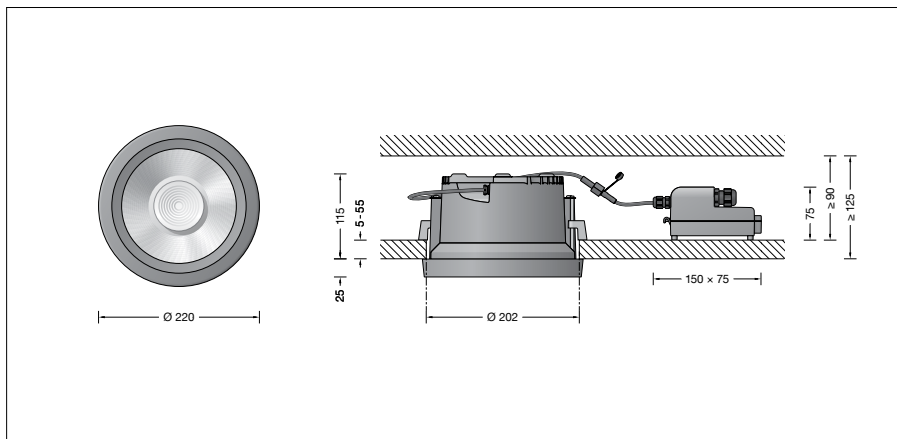

Project · Reference number

Date



Product data sheet

Product description

Luminaire made of aluminium alloy, aluminium and stainless steel
 BEGA Unidure® coating technology
 Cover ring aluminium alloy
 Clear safety glass
 Optical silicone lens · BEGA Hybrid Optics®
 Reflector surface made of pure aluminium
 Luminaire housing with 2 fixing claws and guide screws
 Recessed opening \varnothing 202 mm
 Recessed depth required 125 mm
 The external connection housing is made of glass fibre reinforced synthetic material (polyamide)
 220-240 V \sim 0/50-60 Hz
 2 screw cable glands with strain relief for through-wiring power connecting cable \varnothing 4–10 mm, max. 5 x 1.5[□]
 Connecting terminals 2.5[□]
 0,7 m connection cable with plug between the luminaire and the power supply unit
 BEGA Thermal Control®
 Temporary thermal regulation to protect temperature-sensitive components without switching off the luminaire
 Safety class II 
 Protection class IP 65
 Dust-tight and protection against water jets
 Impact strength IK09
 Protection against mechanical impacts < 10 joule
 – Safety mark
 – Conformity mark
 Weight: 2.2 kg

Application

LED recessed ceiling downlight with external DALI controllable power supply unit for installation into concrete ceilings or suspended ceilings both indoors and out.
 With symmetrical wide beam light distribution.

Lamp

Module connected wattage	35.7 W
Luminaire connected wattage	39.2 W
Rated temperature	$t_a = 25^\circ\text{C}$
Ambient temperature	$t_{a\text{max}} = 35^\circ\text{C}$

24 249 K3

Module designation	LED-0785/830
Colour temperature	3000 K
Colour rendering index	CRI > 80
Module luminous flux	6010 lm
Luminaire luminous flux	4295 lm
Luminaire luminous efficiency	109,6 lm/W

24 249 K4

Module designation	LED-0785/840
Colour temperature	4000 K
Colour rendering index	CRI > 80
Module luminous flux	6165 lm
Luminaire luminous flux	4406 lm
Luminaire luminous efficiency	112,4 lm/W

Service life · Ambient temperature

Rated temperature $t_a = 25^\circ\text{C}$	
LED psu:	> 50,000 h
LED module:	120,000 h (L80 B50)

Ambient temperature $t_{a\text{max}} = 35^\circ\text{C}$ (100 %)	
LED psu:	50,000 h
LED module:	95,000 h (L80 B50) 100,000 h (L70 B50)

Ambient temperature $t_{a\text{max}} = 50^\circ\text{C}$ (50 %)	
LED psu:	50,000 h
LED module:	50,000 h

BEGA Thermal Control® protects temperature-sensitive luminaire components by temporarily limiting the nominal power at high temperatures.

Inrush current

Inrush current: 5 A / 100 μs
 Maximum number of luminaires of this type per miniature circuit breaker:
 B 10A: 27 luminaires
 B 16A: 44 luminaires
 C 10A: 27 luminaires
 C 16A: 44 luminaires

Lighting technology

Half beam angle 28°
 Luminaire data for the light planning program DIALux for outdoor lighting, street lighting and interior lighting as well as luminaire data in EULUMDAT and IES format are available on our website www.bega.com.

Article No. 24 249

LED colour temperature optionally 3000 K or 4000 K
 3000 K – Article number + **K3**
 4000 K – Article number + **K4**

Colour optionally graphite or white
 Graphite – Article number
 White – Article number + **W**

Accessories

10 443 Installation housing

A separate instructions for use can be provided upon request.

Light distribution

