





Tolomeo Mini Table - Aluminum



IP20     

DESIGN BY

Michele De Lucchi, Giancarlo Fassina

DESCRIPTION

Base and cantilevered arms in polished aluminium; diffuser in matt anodised aluminium; joints and supports in polished aluminium. System of spring balancing. The code is referred to the body lamp only

TECHNICAL DRAWINGS

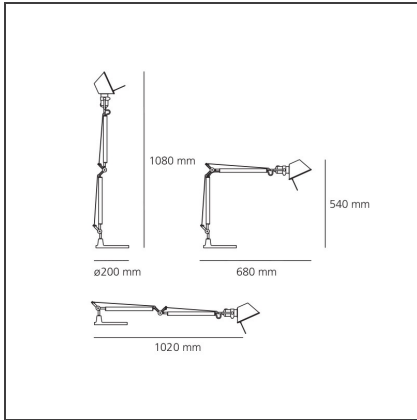

FEATURES

| | | | |
|----------------------|-----------|------------------|------------------|
| Article Code: | A005910 | Material: | aluminium, steel |
| Colour: | Aluminium | Series: | Design |
| Installation: | Table | | |

DIMENSIONS

| | | | |
|------------------------------|--------|------------------------------|--------|
| Length: | cm 68 | Max Extension Length: | cm 102 |
| Height: | cm 54 | Impact Resistance: | N/D |
| Base Diameter: | cm 20 | Glow Wire Test: | N/D |
| Max Extension Height: | cm 108 | | |

NOT INCLUDED SOURCES

| | | | |
|----------------------|-------|-------------------------------|-------|
| Category: | HALO | Color Rendering: | 1a |
| Number: | 1 | Color temperature (K): | 2900K |
| Watt: | 77W | | |
| Lbs: | A60 | | |
| Socket: | E27 | | |
| Duration (h): | 1000h | | |

ALTERNATIVE SOURCES

| | |
|------------------|-----|
| Category: | LED |
| Number: | 1 |
| Watt: | 8W |
| Type: | 2 |
| Socket: | E27 |
| Class: | A |

LUMINAIRE

| | | | |
|-----------------|-----------|--------------------------------------|--------|
| Watt: | 77W | Delivered lumens output (lm): | 1180lm |
| Voltage: | 220V-240V | CCT: | 2900K |

Notes

Interchangeable support: table base, clamp, desk fixed support and twin support that allows two independent lamp units to be fitted. Possibility to mount LED source on E27 Socket

ACCESSORIES

TOLOMEO
MORSETTO
A004100

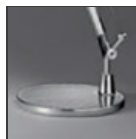

TOLOMEO BASE D
200 ALL
A008600



TOLOMEO
SUPP.TAVOLO
FISSO
A004200